

fischer 

Catalogue Installation Systems



Foreword

Dear business partners,

Technical innovations as well as increasing customer and environmental requirements: many trends are moving building services engineering and require a reliable partner.

We offer a wide range of fixing and installation solutions that simplifies and speeds up MEP Installation in order to shorten construction time and thus reduce your project costs. Versions with electrogalvanized coating are suitable for installations in buildings. Installation systems in hot-dip galvanized or stainless steel are also available for outdoor use and in highly corrosive atmospheres. New is our fully hot dip galvanized Heavy-duty channels systems FMS, which enables you to implement your secondary steel construction projects quickly and safely.

With our comprehensive range of services, we support both planners and contractors worldwide in all construction phases - from consulting and dimensioning, approval procedures, installation and logistics planning to on-site instruction.

We are looking forward to the mutual exchange of ideas and the continued close cooperation with you.

Your suggestions are very valuable to us in order to continuously improve our products, processes and services. Feel free to contact us at any time with your questions and projects.

I hope you enjoy discovering our latest edition of the Installations Systems Catalogue.

Christian Knoll
Managing Director fischer SystemTec



„Whoever chooses fischer receives more than a range of safe products. The aim is to always develop the best solutions for our customers across the globe.“

Besides the innovative products, this predominantly concerns support that is focused on the customer, and services designed to improve customer benefit.

A brand and its promise to perform.

Continious improvement

The fischer ProzessSystem (fPS) we ensure that we are adapting and optimising our processes in line with customer requirements in a flexible manner and on a continuous basis. Thus we are glad having been awarded with the 1. place “Excellence in Operations” within the challenging contest “Factory of the Year”.



Award 2015
Excellence in
Operations

Safety that connects. Decisive quality

We don't make any compromises when it comes to the safety of our products. A whole host of our products are distinguished by comprehensive, up-to-date and international approvals. The fischer product range is well-positioned in all sectors of fixing technology – Steel, Nylon and Chemical fixings. In award-winning quality which continues to impress both professional clients and private customers with equal measure.



See ICC-ES
Evaluation Report
at www.icc-es.org



International approvals characterise many of our products.

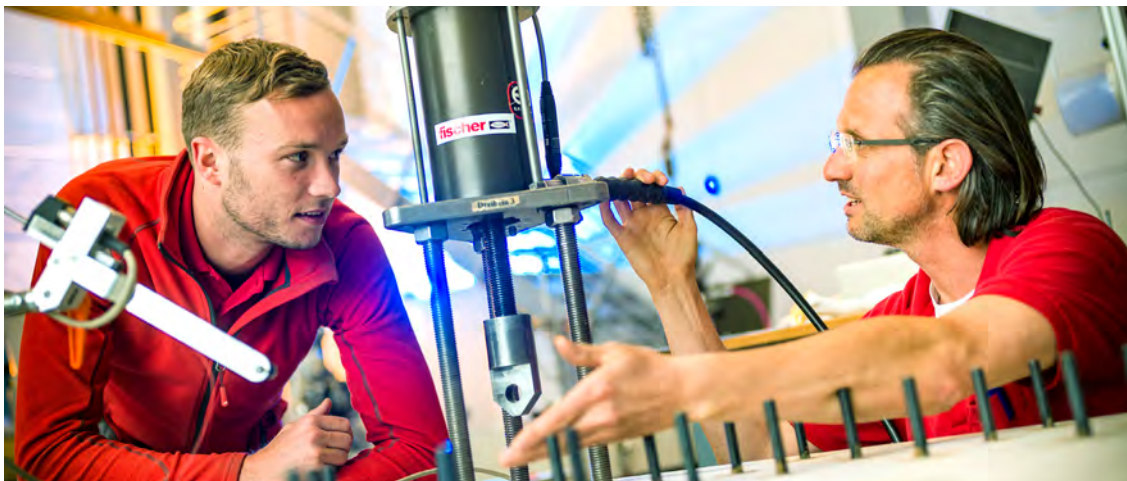



Always on the pulse of time

At fischer, innovation is more than just a sum of the patents. We are open to new things and are prepared for change – always with the aim of offering our customers the greatest possible benefits. Over the years, our own development and production sites have been developing numerous fixing solutions for the most wide-ranging applications. Be it new production procedures or materials, such as renewable raw materials: We are carrying out the research for your safety and will continue to do so in the future. This gives us such great flexibility that we can even develop tailor-made customer solutions. This power to innovate has seen fischer become market leader in anchor technology and the fixing industry.

Our service to you

We are a reliable partner, one that will stand at your side and address your individual requirements with advice and action:

- Our products range from chemical systems to steel anchors through to plastic anchors.
- Competence and innovation through own research, development and production.
- Global presence and active sales service in over 100 countries.
- Qualified technical consulting for economical and compliant fastening solutions. Also on-site at the construction site requested.
- Training sessions, some with accreditation, at your premises or at the fischer academy.
- Design and construction software for demanding applications.

We take responsibility

Our active environment management policy means that we are helping to maintain an intact environment for our generation and for those that follow. The environment management policy at the Tumlingen site has been certified in line with DIN EN ISO 14001. It fills us with particular pride that in 2020 we have received the most important and largest award in Europe in the field of sustainability: the German Sustainability Award - category large companies. This was in recognition of our holistic approach and the strategic anchoring of our sustainability management. With our greenline products we have launched the first range of fixings on the market that is based on renewable raw materials to more than 50%.



Greenline assortment based on 50% regrowing raw materials



German Sustainability Award

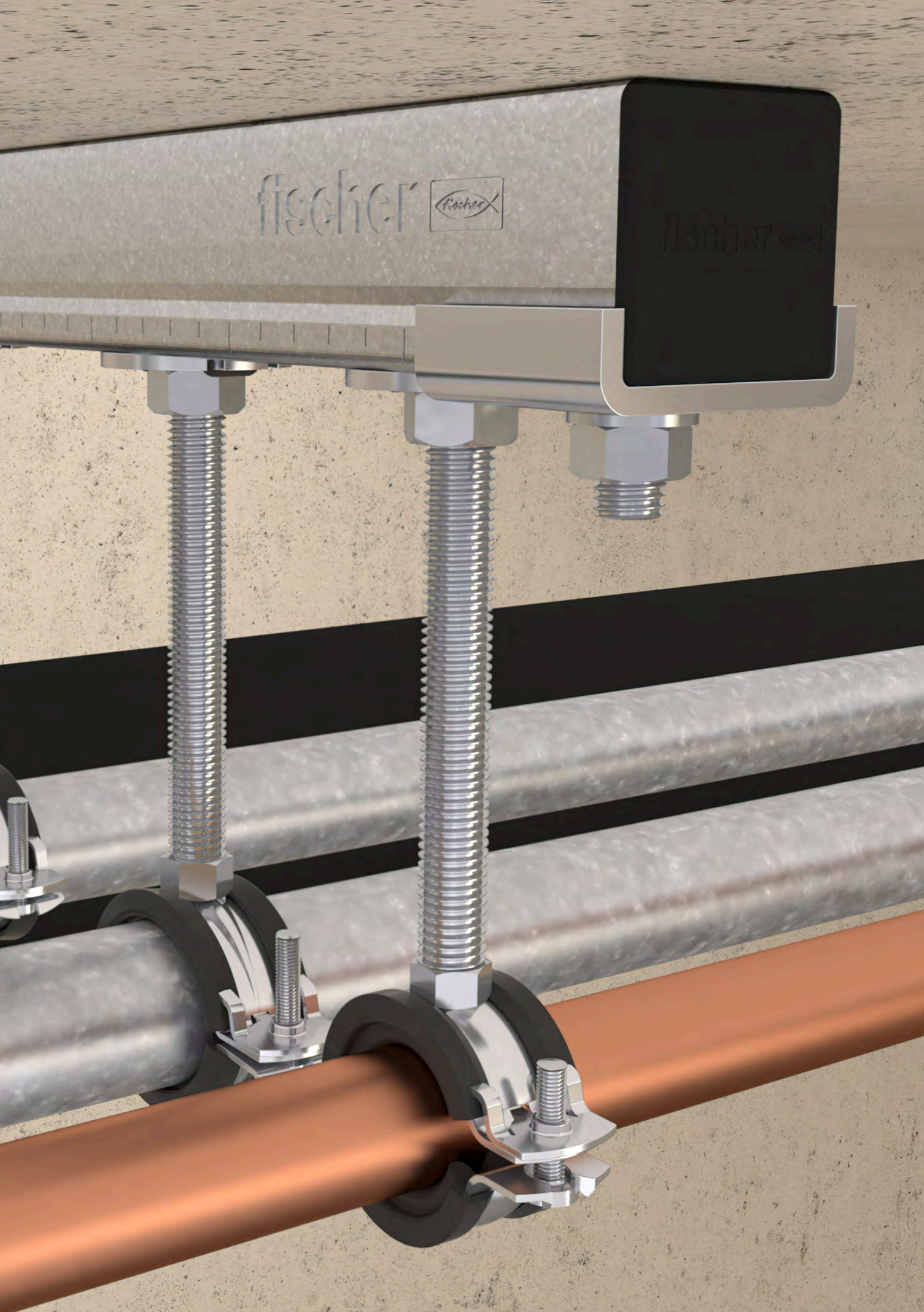

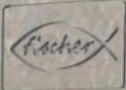
fischer 

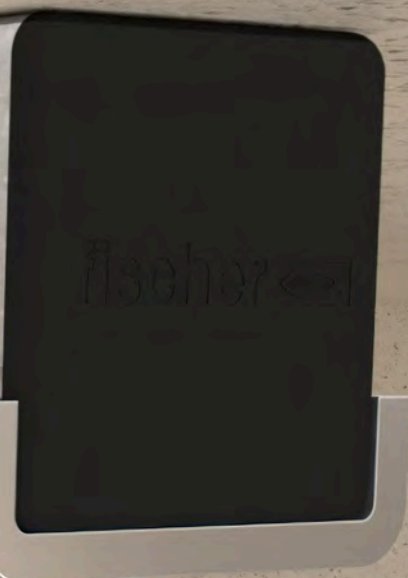



















fischer 

Innovations to inspire professionals

Content













Products – Detailed overview	8	Chapter	1
Pipe clamps	23	Chapter	2a
Light channel system FLS	67	Chapter	2b
Channel system universal FUS	97	Chapter	2c
Installation grid	151	Chapter	2d
Fixpoint and sliding elements	163	Chapter	2e
Seismic bracing assortment	173	Chapter	2f
Air duct and metal roof fixings	185	Chapter	2g
Accessories	199	Chapter	2h
Channel system FUS hdg.	227	Chapter	3a
Massive channel system FMS	279	Chapter	3b
Installation system stainless steel	327	Chapter	4
Air conditioner fixings	341	Chapter	5
Electrical fixings	347	Chapter	6
Sanitary fixings	391	Chapter	7
Plugs and anchors	401	Chapter	8
Fire protection system FireStop	447	Chapter	9
Service	457	Chapter	10

Pipe clamps

Product		Qualification			Type of pipes			Example of pipes	Page
		Fire tested	VdS-approved	FM-approved	light pipes	medium heavy pipes	heavy pipes		
Type	Image								
Hinged pipe clamp FGRS Plus		-	-	-	●	○	-	heating pipes, drinking water and service water pipes, medical gas supply	24
Hinged pipe clamp FGRS		-	-	-	●	○	-	heating pipes, drinking water and service water pipes, medical gas supply	26
Hinged pipe clamp FKS Plus for plastic pipes		-	-	-	●	○	-	heating pipes, drinking water and service water pipes	28
Pipe clamp FRS Plus		-	-	-	○	●	-	heating pipes, drinking water and service water pipes, process pipes for gases and liquids	30
Pipe clamp FRS-L Universal		●	-	-	●	○	-	heating pipes, drinking water and service water pipes, medical gas supply	32
Pipe clamp FRS Triple		-	-	-	○	●	-	gas and compressed air pipes, process pipes for gases and liquids	34
Pipe clamp FRS		●	-	-	○	●	-	heating pipes, drinking water and service water pipes, process pipes for gases and liquids	36
Silicone pipe clamp FRSH		-	-	-	○	●	-	steam pipes	38
Pipe clamp FRSN Triple		-	-	-	○	●	-	gas and compressed air pipes, process pipes for gases and liquids	40
Pipe clamp FRSN		-	-	-	○	●	-	gas and compressed air pipes, process pipes for gases and liquids	42
Heavy duty pipe clamp FRSM – inch		-	-	-	-	●	○	heating pipes, Process pipes for gases and liquids	44
Heavy duty pipe clamp FRSM – metric		-	-	-	-	○	●	heating pipes, Process pipes for gases and liquids	46
Refrigeration pipe clamp FRS K		-	-	-	○	●	-	cooling pipes	48
Refrigeration pipe clamp KFT		-	-	-	-	●	○	cooling pipes	50
Sprinkler clamp FRSP		-	-	●	○	●	○	sprinkler pipes	53
Sprinkler clamp FRSL		-	●	-	○	●	○	sprinkler pipes	55
Riser clamp RCWR									59
U-Clamp FUBD		-	-	-	●	○	-	gas and compressed air pipes, process pipes for gases and liquids	61
U-bolt ETR		-	-	-	○	●	○	sprinkler pipes, gas and compressed air pipes	93
Hose clamp SGS		-	-	-	●	○	-	rubber pipes	-













○ possible ● recommended – not recommendable

Channel system FLS

Product		Qualification Fire tested	Type of pipes			Example of pipes	Page
Type	Image		light pipes	medium heavy pipes	heavy pipes		
Channel FLS		●	●	○	–	heating pipes, air ventilation, drinking water and service water pipes, Medical gas supply	68
FLS Cutting Tool		–	–	–	–	–	71
Cantilever arm ALK		●	●	○	–	process pipes for gases and liquids, cable trays	73
Angle brace WS 31- 45°		–	●	○	–	heating pipes, drinking water and service water pipes, cable trays	76
Channel connector SV 31		–	●	○	–	–	78
Sliding channel nut FSM Clix P		●	●	○	–	heating pipes, drinking water and service water pipes, medical gas supply	80
Sliding channel nut FSM Clix M		●	●	○	–	heating pipes, drinking water and service water pipes, medical gas supply	82
T-head bolt FHS Clix		●	●	○	–	heating pipes, drinking water and service water pipes, medical gas supply	84
Saddle flange SF Clix 31		–	●	○	–	–	86
Angle bracket MW Clix 90°		–	●	○	–	–	88
Angle bracket MW and MWU		–	●	○	–	–	90
Channel washer HK 31		●	●	○	–	–	92
Beam clamp TKR 31		–	●	○	–	–	92











○ possible ● recommended – not recommendable

Channel system universal FUS

Product		Qualification Fire tested	Type of pipes			Example of pipes	Page
Type	Image		light pipes	medium heavy pipes	heavy pipes		
Channel FUS		●	○	●	○	heating pipes, drinking water and service water pipes, gas and compressed air pipes	98
Channel connector FDCC		-	○	●	○	-	104
Cantilever arm FCA		●	-	●	○	process pipes for gases and liquids, cable trays	106
Large cantilever arm FCAM		-	-	●	●	heating pipes, Cooling pipes, process pipes for gases and liquids	110
Cover cap FEC		-	-	-	-	-	111
Push-through connector PFCN		-	○	●	○	-	112
Saddle flange PSF		-	○	●	○	heating pipes, drinking water and service water pipes, gas and compressed air pipes	114
Universal bracket PUWS		-	○	●	○	heating pipes, drinking water and service water pipes, gas and compressed air pipes	115
Angle bracket PWK		-	○	●	○	heating pipes, drinking water and service water pipes, gas and compressed air pipes	116
Variable bracket PVB		-	○	●	○	-	117
Bracing elements PSAE		-	○	●	○	-	118
Channel connector FUF OC and PFUF OC		-	○	●	○	heating pipes, drinking water and service water pipes, gas and compressed air pipes	120
Bracket PFFF		-	○	●	○	heating pipes, drinking water and service water pipes, gas and compressed air pipes	121
Bracket PFAF		-	○	●	○	heating pipes, drinking water and service water pipes, gas and compressed air pipes	122
Bracket PFUF		-	○	●	○	heating pipes, drinking water and service water pipes, gas and compressed air pipes	124
Bracket PFUF D		-	○	●	○	heating pipes, drinking water and service water pipes, gas and compressed air pipes	125





○ possible ● recommended - not recommendable

Channel system universal FUS

Product		Qualification Fire tested	Type of pipes			Example of pipes	Page
Type	Image		light pipes	medium heavy pipes	heavy pipes		
T-head bolt FHS Clix S		-	○	●	○	heating pipes, drinking water and service water pipes, medical gas supply	128
T-head bolt FCSN		-	○	●	○	heating pipes, drinking water and service water pipes, medical gas supply	130
Channel nut FCN		-	○	●	○	ventilation pipes, gas and compressed air pipes	132
Channel washer HK 41		●	○	●	○	-	133
Saddle flange SF		●	-	●	○	-	134
Mounting bracket UWS		●	-	●	○	-	135
Angle bracket WK		-	○	●	○	-	136
Bracket FFF		-	○	●	○	-	138
Bracket FAF		-	○	●	○	-	139
Flanges FZF		-	-	●	○	-	140
Variable bracket VB		-	○	●	○	-	142
Universal mounting UHRS		-	-	●	○	-	143
Universal hinge FUH		-	○	●	○	-	144
Threaded rod bracket FSB 45°		-	○	●	○	-	146
Beam clamp TKR		-	○	●	○	-	147







○ possible ● recommended - not recommendable

Installation grid

Product	Image	Type of pipes			Example of pipes	Page
		light pipes	me- dium heavy pipes	heavy pipes		
Channel FUS		○	●	○	heating pipes, drinking water and service water pipes, gas and compressed air pipes	155
Cross connector FVS II		–	●	○	ventilation ducts and ventilation pipes, drinking water and service water pipes, gas and compressed air pipes, process pipes for gases and liquids, cable trays	154
Channel nut FCN Clix P		○	●	○	heating pipes, drinking water and service water pipes, gas and compressed air pipes	159
Universal hinge FUH		–	●	○	–	159
Hexagonal connector VM		–	–	–	–	158
Turnbuckle SPS, Bolt left-hand/right-hand BLR		●	●	●	–	158
Channel connector FUF OC		–	–	–	–	156
Beam clamp TKR		–	●	○	Installation grid	158
Channel washer HK 41		–	●	○	–	156
Threaded rod G		–	–	–	–	156
Hexagonal nut MU		●	●	–	ventilation ducts and ventilation pipes, sprinkler pipes, water and waste water treatment	157
Washer U		○	●	○	–	157
Hexagonal screw SKS		●	●	●	–	157
Channel nut FCN		●	●	●	–	160
Cover cap FEC		●	●	●	–	159











○ possible ● recommended – not recommendable

Fixpoint and sliding elements







Product		Qualification Fire tested	Type of pipes			Example of pipes	Page
Type	Image		light pipes	medium heavy pipes	heavy pipes		
Sound insulated fix point FSFP		-	○	●	○	heating pipes, drinking water and service water pipes plumbing, cooling pipes	164
Fixpoint clamp FFPS and -saddle FFPK		-	○	●	●	heating pipes, drinking water and service water pipes plumbing, cooling pipes	166
Sliding element GL		-	○	●	○	heating pipes, drinking water and service water pipes plumbing, cooling pipes	167
Sliding saddle SBS		●	○	●	●	heating pipes, drinking water and service water pipes plumbing, cooling pipes	168
Sliding element FSC1		-	●	○	-	heating pipes, drinking water and service water pipes plumbing, cooling pipes	169
Sliding hanger SB		●	●	○	-	heating pipes, drinking water and service water pipes plumbing, cooling pipes	170
Pendulum hanger PDH / PDH K		●	○	●	○	heating pipes, drinking water and service water pipes plumbing, cooling pipes	171

1









Seismic bracing assortment

Product		Qualification			Type of pipes			Example of pipes	Page
Type	Image	Fire tested	VdS-approved	FM-approved	light pipes	medium heavy pipes	heavy pipes		
Seismic pipe clamp FSSC		-	-	●	○	●	-	sprinkler pipes, water pipes plumbing, cooling pipes	174
Channel clamp FUSF		-	-	-	○	●	-	water pipes plumbing, cooling pipes	175
Sway brace bracket FSF		-	-	●	○	●	-	sprinkler pipes, water pipes plumbing, cooling pipes	176
Shaped reinforcement strut SAE		-	-	-	○	●	-	water pipes plumbing, cooling pipes	177
Threaded rod brace connector S-VA		-	-	-	○	●	-	water pipes plumbing, cooling pipes	178
Channel brace connector S-VB		-	-	-	○	●	-	water pipes plumbing, cooling pipes	179
90° angle connector S-FAF		-	-	-	○	●	-	water pipes plumbing, cooling pipes	180
Threaded rod connector S-ROD		-	-	-	○	●	-	water pipes plumbing, cooling pipes	181
Rod stiffener FTRC M12 gvz		-	-	-	○	●	-	water pipes plumbing, cooling pipes	182
Torque bolt SKS M12x30		-	-	-	○	●	-	water pipes plumbing, cooling pipes	183















Air duct and metal roof fixings

Product		Qualification			Type of pipes			Example of pipes	Page
		Fire tested	VdS-approved	FM-approved	light pipes	medium heavy pipes	heavy pipes		
Type	Image								
Ventilation duct clamp LGS		-	-	-	●	○	-	ventilation pipes	186
Duct hanger L- and Z-type		-	-	-	●	○	-	ventilation pipes	188
Spiral duct hanger LRBN / LRB		-	-	-	●	○	-	ventilation ducts	190
Profile hanger TZ / TZH		-	●	●	○	●	-	ventilation ducts and ventilation pipes, sprinkler pipes, water and waste water treatment	192
Hole punch LZ, hole stamp LST		-	-	-	-	-	-	-	194
Rubber inlay EMS		-	-	-	●	○	-	ventilation ducts and ventilation pipes	195

Accessories

Product		Qualification				Type of pipes			Example of pipes	Page
		Fire tested	VdS-approved	FM-approved	UL-approved	light pipes	medium heavy pipes	heavy pipes		
Type	Image									
Clamp hanger TKL		-	●	●	●	●	●	-	ventilation ducts and ventilation pipes, sprinkler pipes, water and waste water treatment	200
Beam Clamp Steel TKLS Steel Bite		-	●	●	-	●	●	-	ventilation ducts and ventilation pipes, sprinkler pipes, water and waste water treatment	202
Threaded rod G /		-	-	-	-	●	●	●	-	204
Threaded stud GS		-	-	-	-	●	●	●	-	204
Base plate GPL, GPS		-	-	-	-	○	●	-	ventilation ducts and ventilation pipes, sprinkler pipes, water and waste water treatment	206
Stud screw STST with bit head and Hex shank		-	-	-	-	-	-	-	-	207
Support hanger AHB		-	-	-	-	●	●	●	-	209
Multi connector MW		-	-	-	-	●	-	-	-	210
Parallel connector PV		-	-	-	-	●	○	-	-	211

Products - Detailed overview



Product	Image	Qualification				Type of pipes			Example of pipes	Page
		Fire tested	VdS-approved	FM-approved	UL-approved	light pipes	medium heavy pipes	heavy pipes		
Type										
Double connector plate DPP, DPF		-	-	-	-	●	○	-	heating pipes, water treatment	212
Bolt connector SBB		-	-	-	-	●	○	-	-	213
Turnbuckle SPS, Bolt left-hand / right-hand BLR		-	-	-	-	-	●	○	Installation grid	213
Hexagonal screw SKS		-	-	-	-	●	●	-	heating pipes, water and waste water treatment	214
Hexagonal nut MU		-	-	-	-	●	●	●	-	215
Washer U		-	-	-	-	●	●	-	-	214
Reduction socket RDM and GRD		-	-	-	-	●	●	-	-	215
Eyebolt AG		-	-	-	-	●	●	-	-	216
Thread hanger RAH		-	-	-	-	●	○	-	-	216
Reduction pieces		-	-	-	-	●	●	○	-	217
Reduction socket RDM and GRD		-	-	-	-	●	●	○	-	217
Flat eye screw LLS		-	-	-	-	●	○	-	heating pipes, water and waste water treatment, temporary pipes	218
Textile web strapping GWB		-	-	-	-	●	○	-	heating pipes, water and waste water treatment, temporary pipes	219
Perforated steel banding LBV / LBK		-	-	-	-	●	-	-	-	220
Impact nail ED		-	-	-	-	-	-	-	-	222

○ possible











● recommended

- not recommendable



Installation system FUS hot-dip galvanised

Product	Image	Qualification Fire tested	Type of pipes			Example of pipes	Page
			light pipes	medium heavy pipes	heavy pipes		
Pipe clamp FRS zl		-	○	●	-	heating pipes, drinking water and service water pipes, gas and compressed air pipes	228
Channel FUS hdg.		●	-	●	○	heating pipes, drinking water and service water pipes, gas and compressed air pipes	232
Channel connector FUF OC hdg.		-	○	●	○	heating pipes, drinking water and service water pipes, gas and compressed air pipes	237
Cantilever arm FCA hdg.		●	-	●	○	process pipes for gases and liquids, cable trays	238
Large cantilever arm FCAM hdg.		-	-	●	●	-	241
Push-through connector PFCN 41 zl		-	○	●	○	-	244
Saddle flange PSF zl		-	○	●	○	heating pipes, drinking water and service water pipes, gas and compressed air pipes	246
Universal bracket PUWS zl		-	○	●	○	heating pipes, drinking water and service water pipes, gas and compressed air pipes	248
Angle bracket PWK zl		-	○	●	○	heating pipes, drinking water and service water pipes, gas and compressed air pipes	249
Variable bracket PVB zl		-	○	●	○	-	250
Bracing elements PSAE zl		-	○	●	○	-	251
Bracket PFFF zl		-	○	●	○	heating pipes, drinking water and service water pipes, gas and compressed air pipes	254
Bracket PFAF zl		-	○	●	○	heating pipes, drinking water and service water pipes, gas and compressed air pipes	253
Bracket PFUF zl		-	○	●	○	heating pipes, drinking water and service water pipes, gas and compressed air pipes	256
Brackets PFUF D zl		-	○	●	○	heating pipes, drinking water and service water pipes, gas and compressed air pipes	257
Connector FCN Clix P hdg. / FCN Clix M hdg.		●	-	●	○	-	258
Channel washer HK 41 hdg.		●	○	●	○	-	260
Saddle flange SF hdg.		●	-	●	○	-	261
Mounting bracket UWS hdg.		●	-	●	○	-	262



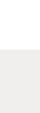

Products - Detailed overview

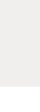
Product		Qualification	Type of pipes			Example of pipes	Page
Type	Image		Fire tested	light pipes	medium heavy pipes		
Angle bracket WK hdg.		-	○	●	○	heating pipes, drinking water and service water pipes, gas and compressed air pipes	263
Bracket FAF hdg.		-	○○	●	○	-	266
Flanges FUF hdg.		-	○○	●	○	heating pipes, drinking water and service water pipes, gas and compressed air pipes	271
Bracket FFF hdg.		-	○	●	○	-	269
Variable bracket VB hdg.		-	-	●	○	-	266
Threaded rod bracket FSB 45° hdg.		-	○○	●	○	-	266
Beam clamp TKR hdg.		-	○	●	○	-	267
Threaded rod G hdg.		-	●	●	●	-	273
Washer U hdg.		-	●	●	●	-	273
Hexagonal nut MU hdg.		-	●	●	●	-	274
Hexagonal screw SKS hdg.		-	●	●	○	-	274

Massiv profile system FMS

Product		Qualification	Type of pipes			Example of pipes	Page
Type	Image		Fire tested	light pipes	medium heavy pipes		
Massive profile FMP		-	-	-	●	Heating, cooling, steam and process pipes, as well as cable trays	280
Channel connector FMPC		-	-	-	●	-	284
Cantilever FMC		-	-	-	●	Different pipes and cable trays	286
Endcap FMEC		-	-	-	●	-	289

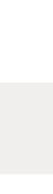

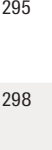
Massiv profile system FMS

Product		Qualification Fire tested	Type of pipes			Example of pipes	Page
Type	Image		light pipes	me- dium heavy pipes	heavy pipes		
Hammer-head push connector FMHB		-	-	-	●	-	290
Connecting element FMCE		-	-	-	●	All pipelines using standard two screwed pipe clamps	294
Connecting element FMCE-L		-	-	-	●	All pipes fixed without insulation by U-bolt	292
Saddle flange FMSF		-	-	-	●	-	296
Base plate FMSF BP		-	-	-	●	-	295
Variable bracket FMVB		-	-	-	●	-	298
Beam clamp FMBC		-	-	-	●	-	300
Beam clamp FMBC M12 and M16		-	-	-	●	-	302
Flat fitting FMFF 90°		-	-	-	●	-	304
Mounting angle FMA 3 and FMA 4		-	-	-	●	-	306
Mounting angle FMA		-	-	-	●	-	308
Connecting element FMUF		-	-	-	●	-	310
Fix point U-bolt FMFS UB		-	-	-	●	-	312
Pipe shoe sliding element FMFS		-	-	-	●	Heating, colling, steam pipes and all pipes which have elongation	314
Fix-point U-bolt FMFS S and M		-	-	-	●	Heating, colling, steam pipes and all pipes which have elongation	316
Pipe shoes FMPS		-	-	-	●	Heating, colling, steam pipes and all pipes which have elongation	318
Massive pipe clamp FMFSC		-	-	-	●	-	322
Massive U-bolt FMPSU		-	-	-	●	-	323

Installation system stainless steel

Product		Qualification Fire tested	Type of pipes			Example of pipes	Page
Type	Image		light pipes	medium heavy pipes	heavy pipes		
Pipe clamp FRS A2/A4		-	○	●	-	heating pipes, drinking water and service water pipes, medical gas supply	328
Channel MS-L A2/A4		●	○	●	○	heating pipes, drinking water and service water pipes, medical gas supply	329
Cantilever arm ALK A2		-	●	○	-	process pipes for gases and liquids, cable trays	329
Schiennenverbinder FDCC A4		-	-	-	-	-	330
Saddle flange SF L A4		●	-	●	○	-	331
Mounting bracket FAF A4		-	-	●	○	-	333
Variable bracket VB A2		-	-	-	-	-	334
Beam clamp TKR		-	-	●	○	-	335
Channel washer HK 41		●	○	●	○	-	335
Clix channel nut FCN Clix A4		●	-	●	○	heating pipes, drinking water and service water pipes, gas and compressed air pipes	336
Stud screw STS A2/A4		-	●	●	-	heating pipes, water and waste water treatment	336
Threaded rod G A2/A4		●	●	●	○	ventilation ducts and ventilation pipets	337
Threaded stud GS A4		●	●	●	○	ventilation ducts and ventilation pipets	337
Hexagonal connector VM A4		-	●	●	○	-	338
Washer U A4		-	●	●	○	-	338
Hexagonal nut MU A4		-	●	●	○	-	339
Hexagonal screw SKS A4		-	●	●	○	-	339

Air conditioner fixings

Product		Applications	Page
Type	Image		
Air conditioner fixing MCE		air conditioner on wall	342
Air conditioner fixing KSU		air conditioner on wall	344

○ possible ● recommended – not recommendable

1

2a

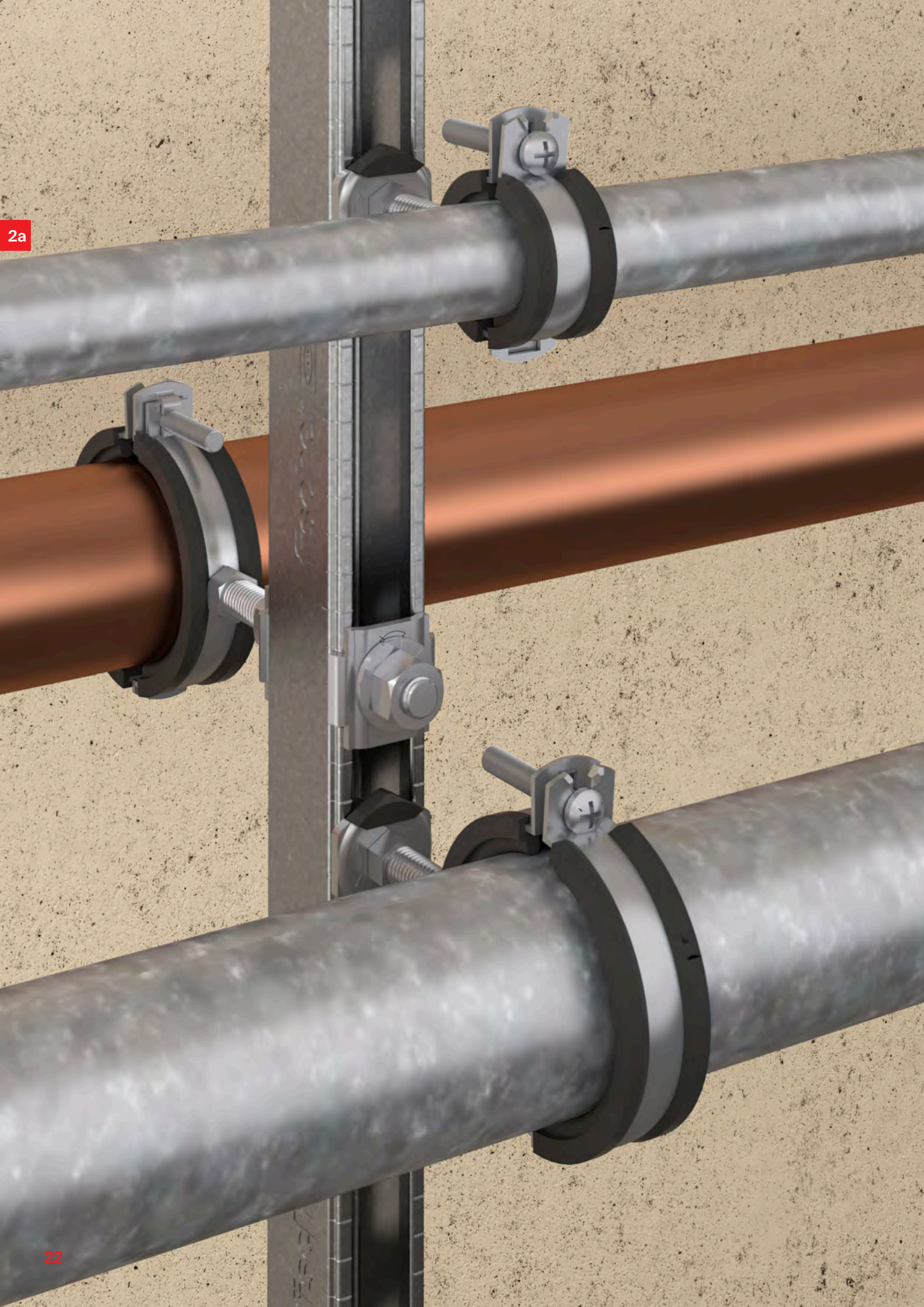

2a

Pipe clamps

SINGLE SCREW PIPE CLAMPS

Hinged pipe clamp FGRS Plus 24 

Hinged pipe clamp FGRS 26 

Hinged pipe clamp FKS Plus for plastic pipes 28 

TWO SCREW PIPE CLAMPS

Pipe clamp FRS Plus 30 

Pipe clamp FRS-L Universal 32 

Pipe clamp FRS Triple 34 

Pipe clamp FRS 36 

Silicone pipe clamp FRSH 38 

Pipe clamp FRSN Triple 40 

Pipe clamp FRSN 42 

HEAVY DUTY PIPE CLAMPS

Heavy duty pipe clamp FRSM - inch 44 

Heavy duty pipe clamp FRSM - metric 46 

INSULATED PIPE CLAMPS

Refrigeration pipe clamp FRS K 48 

Refrigeration pipe clamp KFT 50 

SPRINKLER CLAMPS

Sprinkler clamp FRSP 53 

Sprinkler clamp FRSL 55 

Sprinkler clamp FCHS 57 

Riser clamp RCWR 59 

OTHERS

U-Clamp FUBD 61 

U-bolt ETR 63 

Hose clamp SGS 64 

Hinged pipe clamp FGRS Plus

The one-piece hinged pipe clamp with rapid-locking mechanism

2a

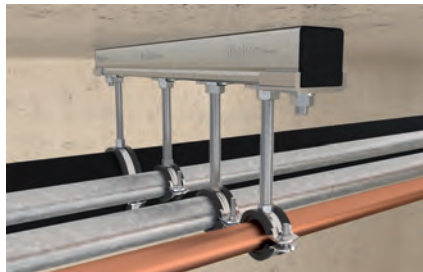

Light, suspended pipelines



Pipelines on cantilevers

Applications

- Time-saving fixing for pipes up to $\text{Ø}2''$ using threaded rods or stud screws

Advantages/benefits

- The rapid-locking mechanism allows a fast and time-saving installation.
- The tight fit of the sound insulation insert prevents it from falling out when inserting the pipe.
- The safety latch fastening guarantees pipe installation without the clamp springing open.
- The combination connecting nut with M8/M10 thread on the FGRS Plus M8/M10 allows optimised mounting choices.
- The screw's combination cross-drive thread allows flexibility during the installation process.
- The compact construction of the pipe clamp enables a simple post-installation insulation.

Properties

- Material: steel DC01 (material no. 1.0330) acc. to DIN EN 10130
- Zinc plating: electro zinc-plated, 5 - 9 μm
- Connecting nut: resistance welded, SW 13
- Locking screw: flat head screw with combination recessed head
- Material sound insulation insert: SBR/EPDM; chlorine-free; silicone-free
- Sound insulation: for DIN 4109
- Temperature range: -40 °C to $+100\text{ °C}$
- Hardness: 55 ± 5 Shore A
- Fire behaviour: DIN 4102: Class B2

Installation FGRS Plus

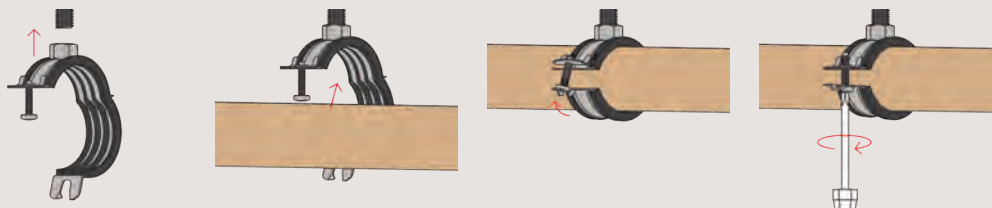

Technical data

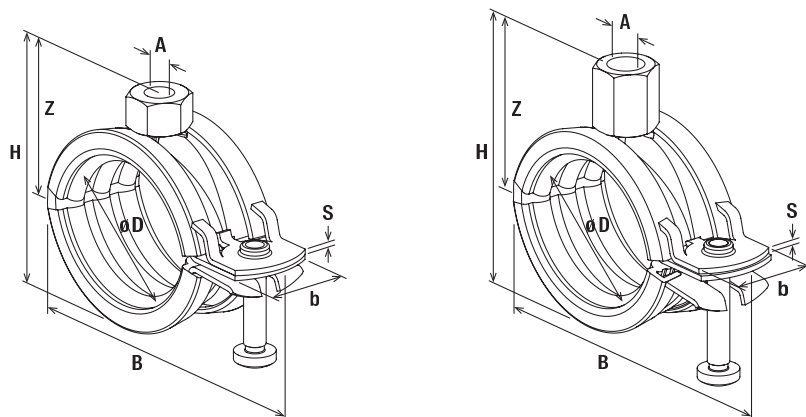

FGRS Plus

FGRS Plus M8/M10

Item	Item No.	Thread	Size	Clamping range	Width	Height	Width x thickness clamp band	Height Z	Locking screw	Max. recom. static load (centr. tension)	Sales unit
		A	[inch]	D [mm]	B [mm]	H [mm]	b x s [mm]	Z [mm]	M 5	$N_{\text{recom.}}$ [kN]	[pcs]
FGRS Plus 12 - 14	079400	M 8	1/4"	12 - 14	48	35	20 x 1.25	21	M 5	0.65	100
FGRS Plus 15 - 19	079401	M 8	3/8"	15 - 19	52	40	20 x 1.25	24	M 5	0.65	100
FGRS Plus 20 - 24	079402	M 8	1/2"	20 - 24	58	45	20 x 1.25	26	M 5	0.65	100
FGRS Plus 25 - 30	079403	M 8	3/4"	25 - 30	63	49	20 x 1.25	28	M 5	0.65	100
FGRS Plus 32 - 37	079404	M 8	1"	32 - 37	72	57	20 x 1.25	32	M 5	0.65	100
FGRS Plus 40 - 44	079405	M 8	1 1/4"	40 - 44	79	66	20 x 1,5	37	M 5	0.90	50
FGRS Plus 45 - 50	079406	M 8	1 1/2"	45 - 50	88	76	20 x 1,5	42	M 5	0.90	50
FGRS Plus 50 - 55	079407	M 8	—	50 - 55	94	82	20 x 1,5	45	M 5	0.90	50
FGRS Plus 56 - 63	079408	M 8	2"	56 - 63	99	85	20 x 1,5	46	M 5	0.90	50

Technical data

Item	Item No.	Thread	Size	Clamping range	Width	Height	Width x thickness clamp band	Height Z	Locking screw	Max. recom. static load (centr. tension)	Sales unit
		A	[inch]	D [mm]	B [mm]	H [mm]	b x s [mm]	Z [mm]	M 5	$N_{\text{recom.}}$ [kN]	[pcs]
FGRS Plus 12 - 14 M8/M10	079430	M 8 / M 10	1/4"	12 - 14	48	46	20 x 1.25	31	M 5	0.65	100
FGRS Plus 15 - 19 M8/M10	079431	M 8 / M 10	3/8"	15 - 19	52	51	20 x 1.25	34	M 5	0.65	100
FGRS Plus 20 - 24 M8/M10	079432	M 8 / M 10	1/2"	20 - 24	58	56	20 x 1.25	36	M 5	0.65	100
FGRS Plus 25 - 30 M8/M10	079433	M 8 / M 10	3/4"	25 - 30	63	60	20 x 1.25	38	M 5	0.65	100
FGRS Plus 32 - 37 M8/M10	079434	M 8 / M 10	1"	32 - 37	72	68	20 x 1.25	42	M 5	0.65	100
FGRS Plus 40 - 44 M8/M10	079435	M 8 / M 10	1 1/4"	40 - 44	79	76	20 x 1,5	47	M 5	0.90	50
FGRS Plus 45 - 50 M8/M10	079436	M 8 / M 10	1 1/2"	45 - 50	88	86	20 x 1,5	52	M 5	0.90	50
FGRS Plus 50 - 55 M8/M10	079437	M 8 / M 10	—	50 - 55	94	92	20 x 1,5	55	M 5	0.90	50
FGRS Plus 56 - 63 M8/M10	079438	M 8 / M 10	2"	56 - 63	99	95	20 x 1,5	56	M 5	0.90	50

Hinged pipe clamp FGRS

The one-piece hinged pipe clamp with floating single screw

2a



Fixation with multi-connector



Leightweight installation on cantilever

Applications

- For economical fixing of pipes up to Ø2" with threaded rods or stud screws

Advantages/benefits

- The floating single screw allows a simple, one-handed installation.
- The safety latch fastening guarantees secure pipe installation without the clamp springing open.
- The compact construction of the pipe clamp enables a simple post-installation insulation.
- The screw's design stops it falling out during the installation.

Properties

- Material: steel DD11 (material no. 1.0332) acc. to DIN EN 10111
- Zinc plating: electro zinc-plated, 5 - 9 µm
- Connecting nut: resistance welded, M8, SW 13
- Locking screw: flat head screw with combination recessed head
- Material sound insulation insert: EPDM; chlorine-free; silicone-free
- Sound insulation: for DIN 4109
- Temperature range: -40 °C to +100 °C
- Hardness: 55 ± 5° Shore A
- Fire behaviour: DIN 4102: Class B2

Installation FGRS

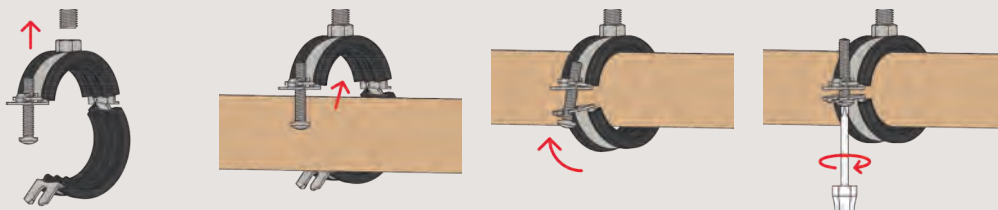

Technical data

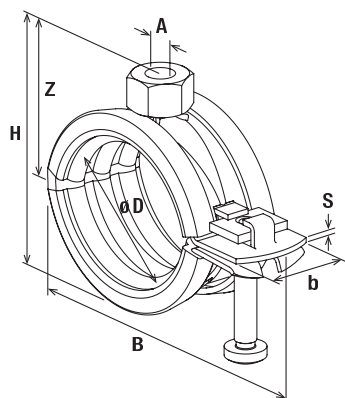

FGRS

Item	Item No.	Thread	Size	Clamping range	Width	Height	Width x thickness clamp band	Height Z	Locking screw	Max. recom. static load (centr. tension) N _{recom.} [kN]	Sales unit [pcs]
		A	[inch]	D [mm]	B [mm]	H [mm]	b x s [mm]	Z [mm]			
FGRS 8 - 11	537212	M 8	—	8 - 11	45	29	20 x 1.25	17	M 5	0.80	100
FGRS 12 - 14	079420	M 8	1/4"	12 - 14	48	31	20 x 1.25	21	M 5	0.80	100
FGRS 15 - 19	079421	M 8	3/8"	15 - 19	52	36	20 x 1.25	24	M 5	0.80	100
FGRS 20 - 24	079422	M 8	1/2"	20 - 24	58	41	20 x 1.25	26	M 5	0.80	100
FGRS 25 - 30	079423	M 8	3/4"	25 - 30	63	47	20 x 1.25	28	M 5	0.80	100
FGRS 32 - 37	079424	M 8	1"	32 - 37	72	54	20 x 1.25	32	M 5	0.80	100
FGRS 40 - 44	079425	M 8	1 1/4"	40 - 44	79	61	20 x 1,5	37	M 5	0.90	50
FGRS 45 - 50	079426	M 8	1 1/2"	45 - 50	88	67	20 x 1,5	42	M 5	0.90	50
FGRS 50 - 55	079427	M 8	—	50 - 55	94	72	20 x 1,5	45	M 5	0.90	50
FGRS 56 - 63	079428	M 8	2"	56 - 63	99	80	20 x 1,5	46	M 5	0.90	50

2a

Hinged pipe clamp FKS Plus for plastic pipes

The one-screw hinged pipe clamp with quick-release fastener for plastic and metal composite pipes

2a



Pipelines

Applications

- Time-saving fixing for plastic and metal composite pipes using threaded rods or stud screws
- Can be used as a slide bracket with spacers or as a fixed point clamp by removing the spacers

Advantages/benefits

- The quick-release fastener allows a fast and time-saving installation.
- The spacing sleeves on the locking screw stops over tightening of the pipes.
- The tight fit of the sound insulation insert prevents it from falling out when inserting the pipe.
- The latch fastening guarantees pipe installation without the clamp springing open.
- The compact construction of the hinged pipe clamp enables a simple post-installation insulation.
- The screw's design stops it falling out during the installation.

Properties

- Material: steel DD11 (material no. 1.0332) acc. to DIN EN 10111
- Zinc plating: electro zinc-plated, 5 - 9 μm
- Connecting nut: resistance welded, M8, SW 13
- Locking screw: flat head screw with combination recessed head
- Material sound insulation insert: NR/SBR/EPDM; chlorine-free; silicone-free
- Sound insulation: for DIN 4109
- Temperature range: $-40\text{ }^{\circ}\text{C}$ to $+110\text{ }^{\circ}\text{C}$
- Hardness: $60 \pm 5^{\circ}$ Shore A
- Fire behaviour: DIN 4102: Class B2

Installation FKS Plus

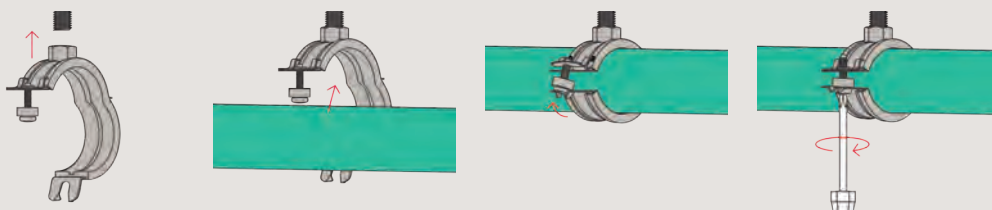

Technical data

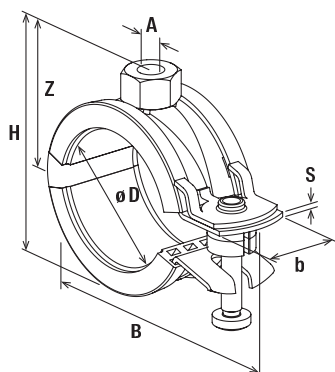

FKS Plus

Item	Item No.	Thread	Size	Clamping range	Width	Height	Width x thickness clamp band	Height Z	Locking screw	Max. recom. static load (centr. tension) $N_{recom.}$ [kN]	Sales unit [pcs]
		A	[inch]	D [mm]	B [mm]	H [mm]	b x s [mm]	Z [mm]			
FKS Plus 15 - 19	079470	M 8	3/8"	15 - 19	52	40	20 x 1.25	24	M 5	0.65	100
FKS Plus 20 - 24	079471	M 8	1/2"	20 - 24	58	45	20 x 1.25	26	M 5	0.65	100
FKS Plus 25 - 30	079472	M 8	3/4"	25 - 30	63	49	20 x 1.25	28	M 5	0.65	100
FKS Plus 32 - 37	079473	M 8	1"	32 - 37	72	57	20 x 1.25	32	M 5	0.65	100
FKS Plus 40 - 44	079474	M 8	1 1/4"	40 - 44	79	66	20 x 1,5	37	M 5	0.90	50
FKS Plus 45 - 50	079475	M 8	1 1/2"	45 - 50	88	76	20 x 1,5	42	M 5	0.90	50
FKS Plus 50 - 55	079476	M 8	—	50 - 55	94	82	20 x 1,5	45	M 5	0.90	50
FKS Plus 56 - 63	079477	M 8	2"	56 - 63	99	85	20 x 1,5	46	M 5	0.90	50

Pipe clamp FRS Plus

The two-screw pipe clamp with rapid-locking mechanism

2a



Suspended pipe under angle bracket

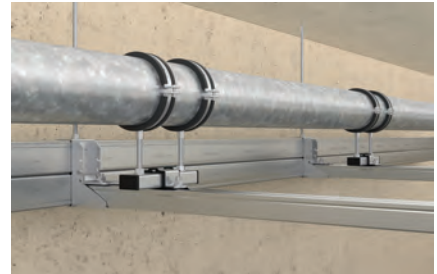

Screwed fixing of insulation boards

Applications

- For simple and easy fixing of pipes using threaded rods or stud screws

Certificates

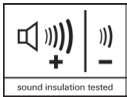

Advantages/benefits

- The rapid-locking mechanism allows for fast and time-saving installation.
- The safety latch fastening guarantees pipe installation without the clamp springing open.
- The tight fit of the sound insulation insert prevents it from falling out when aligning the pipe.
- The combination connecting nut with M8/M10 thread enables optimised mounting choices.
- The two screws allow an easy adjustment to suit the outer pipe diameter.
- The screw's safety feature ensures trouble-free installation.

Properties

- Material: steel DC01 (material no. 1.0330) acc. to DIN EN 10130
- Zinc plating: electro zinc-plated, 5 - 9 µm
- Connecting nut: resistance welded, M8 / M10, SW 13
- Locking screw: flat head screw with combination recessed head
- Material sound insulation insert: EPDM; chlorine-free; silicone-free
- Sound insulation: for DIN 4109
- Temperature range: -40 °C to +100 °C
- Hardness: 55 ± 5° Shore A
- Fire behaviour: DIN 4102: Class B2

Installation FRS Plus

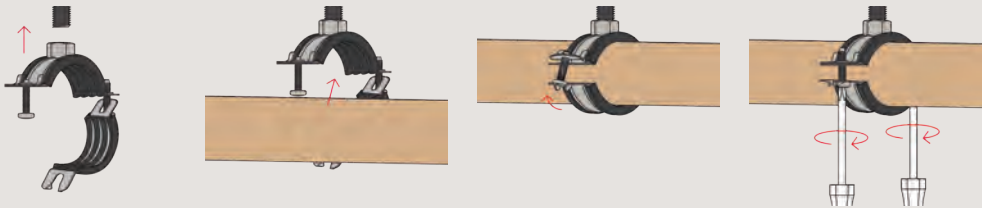

Technical data

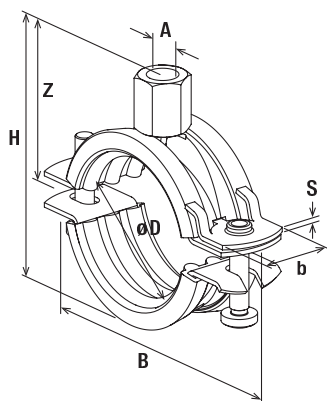

FRS Plus

Item	Item No.	Thread	Size	Clamping range	Width	Height	Width x thickness clamp band	Height Z	Locking screw	Max. recom. static load (centr. tension) N _{recom.} [kN]	Sales unit [pcs]
		A	[inch]	D [mm]	B [mm]	H [mm]	b x s [mm]	Z [mm]			
FRS Plus 12 - 15	079440	M 8 / M 10	1/4"	12 - 15	59	41	20 x 1,25	28	M 5	0.80	100
FRS Plus 15 - 19	079441	M 8 / M 10	3/8"	15 - 19	63	45	20 x 1,25	30	M 5	0.80	100
FRS Plus 20 - 24	079442	M 8 / M 10	1/2"	20 - 24	68	50	20 x 1,25	32	M 5	0.80	100
FRS Plus 25 - 30	079443	M 8 / M 10	3/4"	25 - 30	74	56	20 x 1,25	35	M 5	0.80	100
FRS Plus 32 - 37	079444	M 8 / M 10	1"	32 - 37	81	63	20 x 1,25	39	M 5	0.80	100
FRS Plus 40 - 45	079445	M 8 / M 10	1 1/4"	40 - 45	90	71	20 x 1,5	43	M 5	1.00	50
FRS Plus 48 - 54	079446	M 8 / M 10	1 1/2"	48 - 54	98	80	20 x 1,5	48	M 5	1.00	50
FRS Plus 55 - 61	079447	M 8 / M 10	2"	55 - 61	100	87	20 x 1,5	51	M 5	1.00	50
FRS Plus 63 - 67	079449	M 8 / M 10	—	63 - 67	114	93	20 x 1,5	54	M 5	1.00	25
FRS Plus 68 - 73	079450	M 8 / M 10	—	68 - 73	117	100	20 x 2,0	58	M 6	1.80	25
FRS Plus 72 - 80	079451	M 8 / M 10	2 1/2"	72 - 80	125	107	20 x 2,0	61	M 6	1.80	25
FRS Plus 80 - 86	079452	M 8 / M 10	—	80 - 86	132	113	20 x 2,0	64	M 6	1.80	25
FRS Plus 87 - 92	079453	M 8 / M 10	3"	87 - 92	139	119	20 x 2,0	67	M 6	1.80	25
FRS Plus 95 - 103	079454	M 8 / M 10	—	95 - 103	151	130	20 x 2,0	73	M 6	1.80	25
FRS Plus 108 - 116	079455	M 8 / M 10	4"	108 - 116	163	143	20 x 2,0	79	M 6	1.80	20

Pipe clamp FRS-L Universal

The light two-screw pipe clamp with rapid-locking mechanism and combination connecting nut

2a

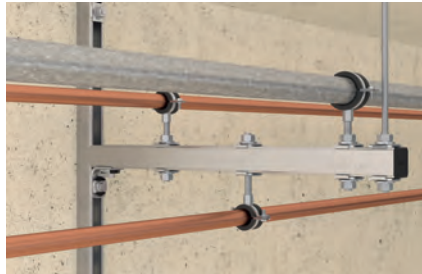

Cantilever construction with channel

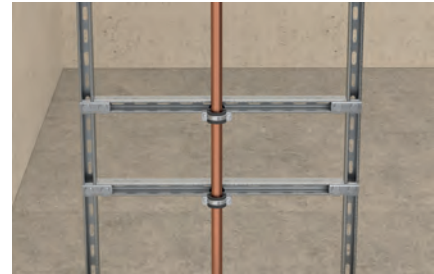

Vertical installation

Applications

- For simple and easy fixing for pipes using threaded rods or stud screws

Certificates



Fire resistance classification
R120



MLAR R30

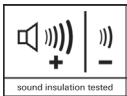

sound insulation tested

Advantage/Benefits

- The fire inspection report and the sound insulation report guarantee objectively tested functional safety.
- The unique rapid-locking mechanism with crimped edges allows a secure and time-saving installation.
- The clamp band with crimped edges gives a tight fit of the sound insulation insert and prevents it from slipping out when aligning the pipe.
- The two screws allow a perfect adaptation of the pipe clamp to suit every outer pipe diameter.
- The connecting nut with combination thread M8/M10 enables an optimised warehousing.
- The screw's loss protection guarantees an easy installation.

Properties

- Material: steel DD11 (material no. 1.0332) acc. to DIN EN 10111
- Zinc plating: electro zinc-plated, min. 5 µm acc. DIN EN ISO 4042
- Connecting nut: resistance welded, M8 / M10, SW 13
- Locking screw: flat head screw with combination recessed head
- Material sound insulation insert: SBR/EPDM; chlorine-free; silicone-free
- Sound insulation: for DIN 4109
- Temperature range: -40 °C to +100 °C
- Hardness: 55 ± 5° Shore A
- Fire behaviour: DIN 4102: Class B2

Installation FRS-L Universal

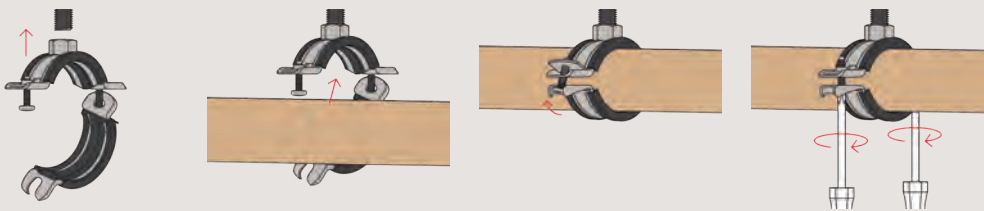

Technical data

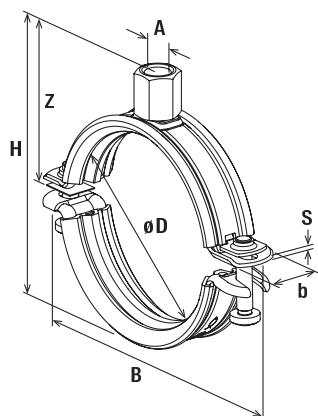

FRS-L Universal

Item	Item No.	Fire test report	Thread	Size	Clamp- ing range		Width	Height	Width x thickness clamp band	Height Z	Locking screw	Max. recom. static load (centr. tension) N _{recom.} [kN]	Sales unit [pcs]
					A	D							
				[inch]	[mm]	[mm]	[mm]	[mm]	[mm]	[mm]			
FRS-L 8 - 11 Universal	539443	X	M 8 / M 10	—	8 - 11	47	35	18 x 1,0	25	M 5	0.70	25	
FRS-L 12 - 15 Universal	539444	X	M 8 / M 10	1/4"	12 - 15	52	39	18 x 1,0	27	M 5	0.70	25	
FRS-L 16 - 19 Universal	539445	X	M 8 / M 10	3/8"	16 - 19	56	43	18 x 1,0	29	M 5	0.70	25	
FRS-L 20 - 24 Universal	539446	X	M 8 / M 10	1/2"	20 - 24	61	48	18 x 1,0	31	M 5	0.70	25	
FRS-L 25 - 30 Universal	539447	X	M 8 / M 10	3/4"	25 - 30	67	53	18 x 1,0	34	M 5	0.70	25	
FRS-L 31 - 37 Universal	539448	X	M 8 / M 10	1"	31 - 37	74	61	18 x 1,0	38	M 5	0.70	25	
FRS-L 38 - 45 Universal	539449	X	M 8 / M 10	1 1/4"	38 - 45	83	69	18 x 1,2	42	M 5	1.00	25	
FRS-L 46 - 52 Universal	539450	X	M 8 / M 10	1 1/2"	46 - 52	90	76	18 x 1,2	45	M 5	1.00	25	
FRS-L 53 - 59 Universal	539451	X	M 8 / M 10	—	53 - 59	97	83	18 x 1,2	49	M 5	1.00	25	
FRS-L 60 - 66 Universal	539452	X	M 8 / M 10	2"	60 - 66	104	90	18 x 1,2	52	M 5	1.00	10	
FRS-L 67 - 75 Universal	539453	X	M 8 / M 10	—	67 - 75	120	100	20 x 1,8	57	M 6	1.30	10	
FRS-L 76 - 84 Universal	539454	X	M 8 / M 10	2 1/2"	76 - 84	130	109	20 x 1,8	62	M 6	1.30	10	
FRS-L 85 - 93 Universal	539455	X	M 8 / M 10	3"	85 - 93	139	118	20 x 1,8	66	M 6	1.30	10	
FRS-L 94 - 100 Universal	539456	X	M 8 / M 10	—	94 - 100	146	125	20 x 1,8	70	M 6	1.30	10	
FRS-L 101 - 110 Universal	539457	X	M 8 / M 10	—	101 - 110	156	135	20 x 1,8	75	M 6	1.30	10	
FRS-L 110 - 119 Universal	539459	X	M 8 / M 10	4"	110 - 119	165	144	20 x 1,8	79	M 6	1.30	10	
FRS-L 120 - 129 Universal	544905	X	M 8 / M 10	—	120 - 129	176	156	25 x 2,0	86	M 6	1.50	5	
FRS-L 130 - 137 Universal	544906	X	M 8 / M 10	—	130 - 137	184	164	25 x 2,0	90	M 6	1.50	5	
FRS-L 138 - 145 Universal	544907	X	M 8 / M 10	5"	138 - 145	192	172	25 x 2,0	94	M 6	1.50	5	
FRS-L 146 - 155 Universal	544908	X	M 8 / M 10	—	146 - 155	202	182	25 x 2,0	99	M 6	1.50	5	
FRS-L 156 - 163 Universal	544909	X	M 8 / M 10	—	156 - 163	211	190	25 x 2,0	103	M 6	1.50	5	
FRS-L 164 - 172 Universal	544910	X	M 8 / M 10	6"	164 - 172	219	199	25 x 2,0	106	M 6	1.50	5	

Pipe clamp FRS Triple

The two-screw pipe clamp with rapid-locking mechanism and triple connecting nut

2a

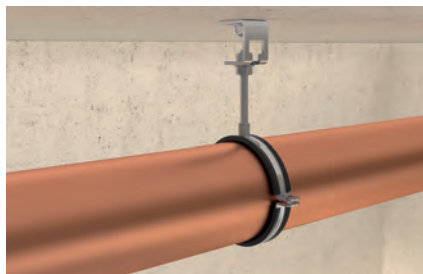

Height adjustable pipe installation

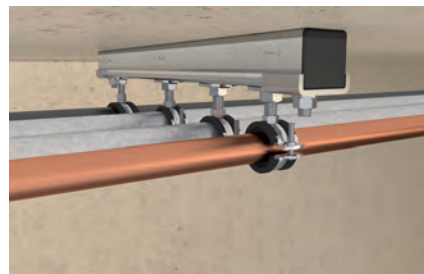

Drainage pipe assembly

Applications

- For simple and easy fixing of pipelines with threaded rods or hanger bolts

Advantages/Benefits

- The connecting nut with combination thread M8 / M10 / 1/2" allows for optimised mounting positioning.
- The rapid-locking mechanism allows for fast and time-saving installation.
- The tight fit of the sound insulation insert prevents it from falling out when aligning the pipe.
- The two screws allow for ideal adaptation to suit the outer pipe diameter.

Properties

- Material: steel DD11 (material no. 1.0332) acc. to DIN EN 10111
- Zinc plating: electro zinc-plated, min. 5 µm
- Connecting nut: resistance welded, M8 / M10 / 1/2"
- Locking screw: flat head screw with combination recessed head
- Material sound insulation insert: SBR/EPDM; chlorine-free; silicone-free
- Sound insulation: for DIN 4109
- Temperature range: -50 °C to +110 °C
- Hardness: 45 ± 5° Shore A
- Fire behaviour: DIN 4102: Class B2

Installation FRS Triple

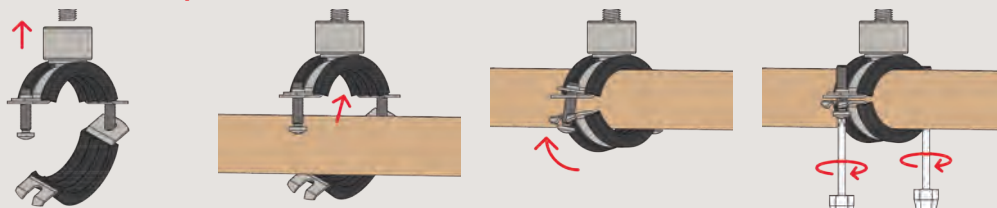

Technical data

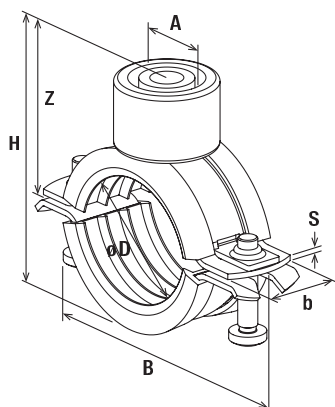

FRS Triple

Item	Item No.	Thread	Size	Clamp- ing range	Width	Height	Width x thickness clamp band	Height Z	Locking screw	Max. recom. static load (centr. tension) $N_{recom.}$ [kN]	Sales unit [pcs]
		A	[inch]	D [mm]	B [mm]	H [mm]	b x s [mm]	Z [mm]			
FRS Triple 15 - 19	500698	M 8 / M 10 / 1/2"	3/8"	15 - 19	61	53	20 x 1,5	36	M 5	1.00	100
FRS Triple 21 - 23	500699	M 8 / M 10 / 1/2"	1/2"	21 - 23	65	57	20 x 1,5	38	M 5	1.00	100
FRS Triple 26 - 28	500700	M 8 / M 10 / 1/2"	3/4"	26 - 28	70	62	20 x 1,5	40	M 5	1.00	100
FRS Triple 32 - 35	500701	M 8 / M 10 / 1/2"	1"	32 - 35	77	69	20 x 1,5	44	M 5	1.00	100
FRS Triple 40 - 43	500702	M 8 / M 10 / 1/2"	1 1/4"	40 - 43	85	77	20 x 1,5	48	M 5	1.00	50
FRS Triple 48 - 56	500703	M 8 / M 10 / 1/2"	1 1/2"	48 - 56	98	90	20 x 1,5	54	M 5	1.00	50
FRS Triple 57 - 62	500704	M 8 / M 10 / 1/2"	2"	57 - 63	104	96	20 x 1,5	57	M 5	1.00	50
FRS Triple 63 - 70	500705	M 8 / M 10 / 1/2"	—	63 - 70	112	104	20 x 1,5	61	M 5	1.00	25
FRS Triple 74 - 80	500706	M 8 / M 10 / 1/2"	2 1/2"	74 - 80	122	114	20 x 1,5	66	M 5	1.00	25
FRS Triple 83 - 91	500707	M 8 / M 10 / 1/2"	3"	83 - 91	133	125	20 x 1,5	72	M 5	1.00	25
FRS Triple 100 - 105	500708	M 8 / M 10 / 1/2"	—	100 - 105	155	139	23 x 2,0	79	M 6	1.50	10
FRS Triple 108 - 114	500709	M 8 / M 10 / 1/2"	4"	108 - 114	164	148	23 x 2,0	83	M 6	1.50	10
FRS Triple 115 - 125	500710	M 8 / M 10 / 1/2"	—	115 - 125	175	159	23 x 2,0	89	M 6	1.50	10
FRS Triple 127 - 135	500711	M 8 / M 10 / 1/2"	—	127 - 135	185	169	23 x 2,0	94	M 6	1.50	10
FRS Triple 135 - 140	500712	M 8 / M 10 / 1/2"	5"	135 - 140	190	174	23 x 2,0	96	M 6	1.50	10
FRS Triple 159 - 169	500713	M 8 / M 10 / 1/2"	6"	159 - 169	219	203	23 x 2,0	111	M 6	1.50	10

Pipe clamp FRS

The two-screw pipe clamp with combination connecting thread

2a

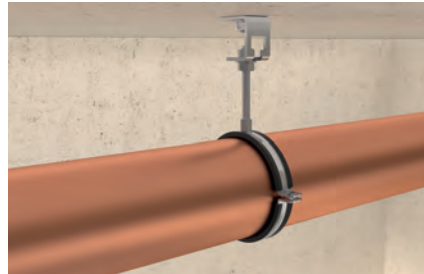

Height adjustable pipe installation



Drainage pipe assembly

Applications

- Secure fixing for pipes with threaded rods or stud screws (also when there are fire protection requirements)

Certificates



Fire resistance classification
R120



MLAR R30

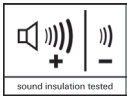

sound insulation tested

Advantages/benefits

- The fire test report guarantees independently tested functional safety.
- The two screws allow an easy adjustment to suit the outer pipe diameter.
- The combination connecting nut with thread M8/M10 enables optimised mounting choices.
- The sound insulation insert offers noise protection and prevents contact corrosion.
- The screw's safety feature ensures trouble-free installation.

Properties

- Material: steel DC01 (material no. 1.0330) acc. to DIN EN 10130
- Zinc plating: electro zinc-plated, 5 - 9 µm
- Connecting nut: resistance welded, M8 / M10, SW 13
- Locking screw: flat head screw with combination recessed head
- Material sound insulation insert: EPDM; chlorine-free; silicone-free
- Sound insulation: for DIN 4109
- Temperature range: -40 °C to +100 °C
- Hardness: 55 ± 5° Shore A
- Fire behaviour: DIN 4102: Class B2

Installation FRS

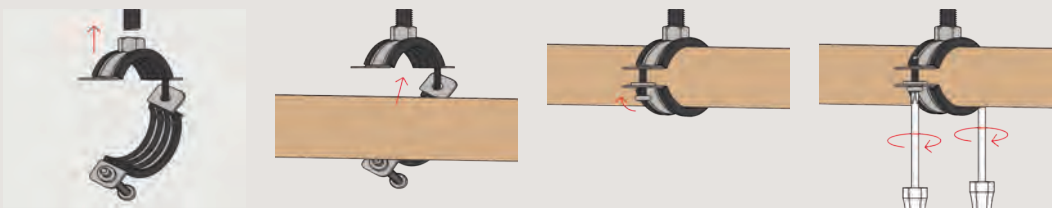

Technical data

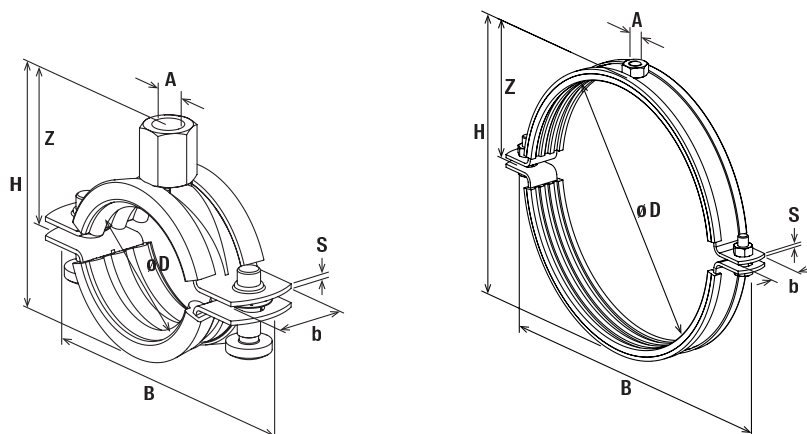

FRS M8/M10

FRS

Item	Item No.	Fire test report	Thread	Size	Clamping range	Width	Height	Width x thickness clamp band	Height Z	Locking screw	Max. recom. static load (centr. tension) N _{recom.} [kN]	Sales unit [pcs]
			A	[inch]	D [mm]	B [mm]	H [mm]	b x s [mm]	Z [mm]			
FRS 12 - 15 M8/M10	510969	X	M 8 / M 10	1/4"	12 - 15	55	39	20 x 1.25	31	M 6	1.00	100
FRS 15 - 19 M8/M10	042535	X	M 8 / M 10	3/8"	15 - 19	59	43	20 x 1.25	29	M 6	1.00	100
FRS 20 - 24 M8/M10	042536	X	M 8 / M 10	1/2"	20 - 24	65	48	20 x 1.25	32	M 6	1.00	100
FRS 25 - 30 M8/M10	042537	X	M 8 / M 10	3/4"	25 - 30	72	54	20 x 1.25	35	M 6	1.00	100
FRS 32 - 37 M8/M10	042538	X	M 8 / M 10	1"	32 - 37	77	61	20 x 1.25	38	M 6	1.00	100
FRS 40 - 45 M8/M10	042554	X	M 8 / M 10	1 1/4"	40 - 45	89	69	20 x 1.25	42	M 6	1.00	50
FRS 48 - 54 M8/M10	510970	X	M 8 / M 10	1 1/2"	48 - 54	99	78	20 x 1.25	46	M 6	1.00	50
FRS 55 - 61 M8/M10	042555	X	M 8 / M 10	2"	55 - 61	105	85	20 x 1.25	50	M 6	1.00	50
FRS 63 - 67 M8/M10	091488	X	M 8 / M 10	—	63 - 67	111	91	20 x 1.25	53	M 6	1.00	50
FRS 72 - 80 M8/M10	091489	X	M 8 / M 10	2 1/2"	72 - 80	125	104	20 x 2.0	60	M 6	1.50	25
FRS 87 - 92 M8/M10	091505	X	M 8 / M 10	3"	87 - 92	137	116	20 x 2.0	66	M 6	1.50	25
FRS 95 - 103 M8/M10	545649	X	M 8 / M 10	—	95 - 103	149	130	25 x 2,0	73	M 6	2.00	25
FRS 108 - 116 M8/M10	091506	X	M 8 / M 10	4"	108 - 116	164	140	25 x 2,0	78	M 6	2.0	20
FRS 121 - 128 M8/M10	079456	X	M 8 / M 10	—	121 - 128	176	152	25 x 2.5	84	M 6	2.50	10
FRS 133 - 141 M8/M10	079457	X	M 8 / M 10	5"	133 - 141	187	165	25 x 2.5	90	M 6	2.50	10
FRS 159 - 165 M8/M10	079458	X	M 8 / M 10	—	159 - 165	211	198	25 x 2.5	102	M 6	2.50	8
FRS 165 - 168 M8/M10	079459	X	M 8 / M 10	6"	165 - 168	225	192	25 x 2.5	104	M 6	2.50	8
FRS 200-206 M10	539660	—	M 10	—	200 - 206	256	227	25 x 2.5	118	M 8	2.75	15
FRS 210-219 M10	558335	—	M 10	—	210 - 219	262	240	25 x 2.5	124	M 8	2.75	15

Silicone pipe clamp FRSH

The two-screw pipe clamp with a sound insulation insert with resistance to high temperatures

2a



Sliding element on cantilever

Applications

- Fixing of high-temperature pipelines with threaded rods or stud screws (e.g. steam pipes)

Advantages/benefits

- The special silicone sound insulation insert allows a use with average temperatures of up to +220 °C.
- The two screws enable an easy adjustment to suit the outer pipe diameter.
- The screw's safety feature ensures trouble-free installation.

Properties

- Material: steel DD11 (material no. 1.0332) acc. to DIN EN 10111
- Zinc plating: electro zinc-plated, 5 - 9 µm
- Connecting nut: (up to FRSH 59 - 63) resistance welded, M8 and M8 / M10 SW 13, M10 SW 17
- Locking screw: flat head screw with combination recessed head
- Material sound insulation insert: silicone
- Sound insulation: for DIN 4109
- Temperature range: -40 °C to +220 °C
- Hardness: 60 ± 5° Shore A
- Fire behaviour: DIN 4102: Class B2

Installation FRSH

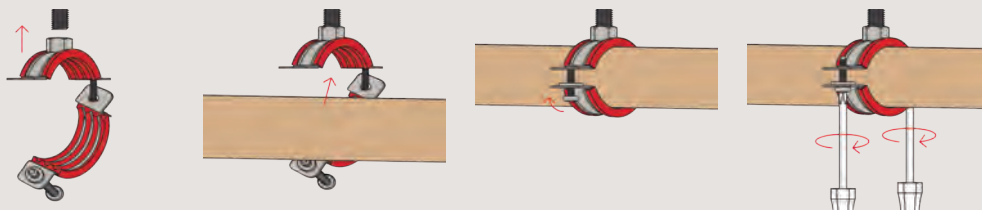

Technical data

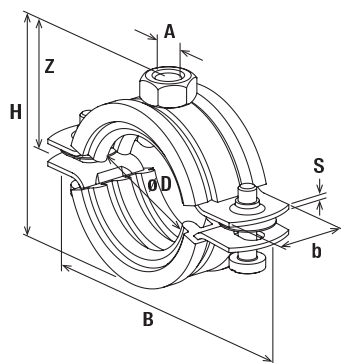

FRSH

Item	Item No.	Thread	Size	Clamping range	Width	Height	Width x thickness clamp band	Height Z	Locking screw	Max. recom. static load (centr. tension) N _{recom.} [kN]	Sales unit [pcs]
		A	[inch]	D [mm]	B [mm]	H [mm]	b x s [mm]	Z [mm]			
FRSH 15 - 19	063490	M 8	3/8"	15 - 19	62	41	20 x 1.25	24	M 5	1.00	100
FRSH 20 - 24	063492	M 8	1/2"	20 - 24	68	46	20 x 1.25	26	M 5	1.00	100
FRSH 25 - 30	063494	M 8	3/4"	25 - 30	75	52	20 x 1.25	29	M 5	1.00	100
FRSH 32 - 37	063495	M 8	1"	32 - 37	80	59	20 x 1.25	33	M 5	1.00	100
FRSH 40 - 45	063498	M 8	1 1/4"	40 - 45	90	67	20 x 1.25	37	M 5	1.00	50
FRSH 48 - 53	063499	M 8	1 1/2"	48 - 53	97	75	20 x 1.25	41	M 5	1.00	50
FRSH 54 - 59	063500	M 8	—	54 - 59	104	81	20 x 1.25	44	M 5	1.00	50
FRSH 60 - 64	063502	M 8	2"	60 - 64	110	86	20 x 1.25	46	M 5	1.00	50
FRSH 68 - 73	063504	M 10	—	68 - 73	122	95	25 x 1,5	51	M 6	1.30	25
FRSH 74 - 78	063505	M 10	2 1/2"	74 - 78	130	100	25 x 1,5	55	M 6	1.30	25
FRSH 80 - 86	063511	M 10	—	80 - 86	130	108	25 x 1,5	58	M 6	1.30	25
FRSH 87 - 92	063513	M 10	3"	87 - 92	141	114	25 x 1,5	61	M 6	1.30	25
FRSH 95 - 103	063518	M 10	—	95 - 103	156	125	25 x 1,5	67	M 6	1.30	25
FRSH 102 - 116	063520	M 10	4"	102 - 116	172	140	25 x 2,0	74	M 6	2.00	20
FRSH 133 - 141	063537	M 8 / M 10	5"	133 - 141	198	174	25 x 2.5	95	M 8	2.00	10
FRSH 159 - 168	091507	M 8 / M 10	—	159 - 168	226	201	25 x 2.5	109	M 8	2.00	8

2a

Pipe clamp FRSN Triple

The two-screw pipe clamp with rapid-locking mechanism and triple connecting nut

2a



Waste water pipe

Applications

- For simple and easy fixing of pipelines with threaded rods or hanger bolts

Advantages/benefits

- The connecting nut with combination thread M8 / M10 / 1/2" allows for optimised mounting positioning.
- The rapid-locking mechanism allows for fast and time-saving installation.
- The two screws allow for ideal adaptation to suit the outer pipe diameter.

Properties

- Material: steel DD11 (material no. 1.0332) acc. to DIN EN 10111
- Zinc plating: electro zinc-plated, min. 5 µm
- Connecting nut: resistance welded, M8 / M10 / 1/2"
- Locking screw: flat head screw with combination recessed head

Installation FRSN Triple

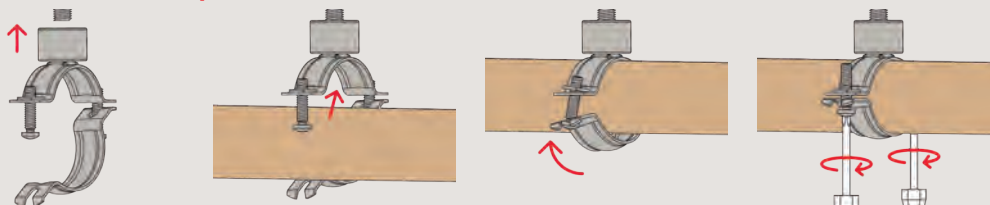

Technical data

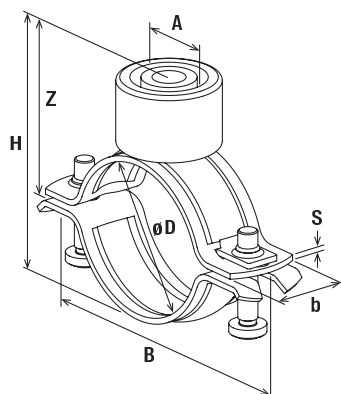

FRSN Triple

Item	Item No.	Thread A	Size [inch]	Clamping range D [mm]	Width B [mm]	Height H [mm]	Width x thickness clamp band b x s [mm]	Height Z Z [mm]	Locking screw	Max. recom. static load (centr. tension) N _{recom.} [kN]	Sales unit [pcs]
FRSN Triple 15 - 19	500714	M 8 / M 10 / 1/2"	3/8"	15 - 19	54	44	20 x 1,5	32	M 5	1.00	100
FRSN Triple 21 - 23	500715	M 8 / M 10 / 1/2"	1/2"	21 - 23	58	48	20 x 1,5	34	M 5	1.00	100
FRSN Triple 26 - 28	500716	M 8 / M 10 / 1/2"	3/4"	26 - 28	63	53	20 x 1,5	36	M 5	1.00	100
FRSN Triple 32 - 35	500717	M 8 / M 10 / 1/2"	1"	32 - 35	70	60	20 x 1,5	40	M 5	1.00	100
FRSN Triple 40 - 43	500718	M 8 / M 10 / 1/2"	1 1/4"	40 - 43	78	68	20 x 1,5	44	M 5	1.00	50
FRSN Triple 48 - 56	500719	M 8 / M 10 / 1/2"	1 1/2"	48 - 56	91	81	20 x 1,5	50	M 5	1.00	50
FRSN Triple 57 - 62	500720	M 8 / M 10 / 1/2"	2"	57 - 63	97	87	20 x 1,5	53	M 5	1.00	50
FRSN Triple 63 - 70	500721	M 8 / M 10 / 1/2"	—	63 - 70	105	95	20 x 1,5	57	M 5	1.00	50
FRSN Triple 74 - 80	500722	M 8 / M 10 / 1/2"	2 1/2"	74 - 80	115	105	20 x 1,5	62	M 5	1.00	25
FRSN Triple 83 - 91	500723	M 8 / M 10 / 1/2"	3"	83 - 91	126	116	20 x 1,5	68	M 5	1.00	25
FRSN Triple 100 - 105	500724	M 8 / M 10 / 1/2"	—	100 - 105	148	130	23 x 2,0	74	M 6	1.50	10
FRSN Triple 108 - 114	500725	M 8 / M 10 / 1/2"	4"	108 - 114	157	139	23 x 2,0	78	M 6	1.50	10

Pipe clamp FRSN

The two-screw pipe clamp without sound insulation insert

2a



Waste water pipe

Applications

- Fixing of metal or plastic pipes without sound insulation requirements with threaded rods or stud screws (e.g. in industrial constructions)

Advantages/benefits

- The FRSN without the sound insulation insert is ideal for use in industrial applications and plastic pipes.
- The combination connecting nut with thread M8/M10 allows for optimised mounting choices.
- The two screws enable ideal adaptation to suit the outer pipe diameter.
- The screw's safety feature ensures trouble-free installation.

Properties

- Material: steel DD11 (material no. 1.0332) acc. to DIN EN 10111
- Zinc plating: electro zinc-plated, 5 - 9 µm
- Connecting nut: resistance welded M8 / M10, SW 13, M10 / M12, SW 17
- Locking screw: flat head screw with combination recessed head

Installation FRSN

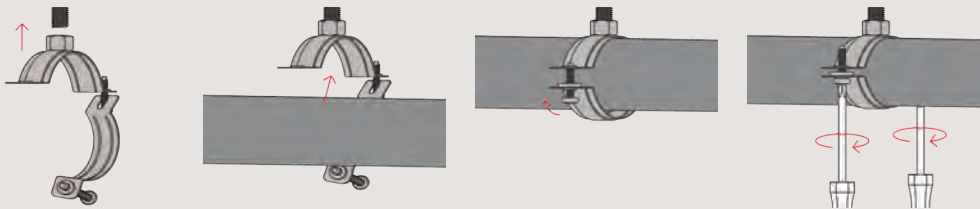

Technical data

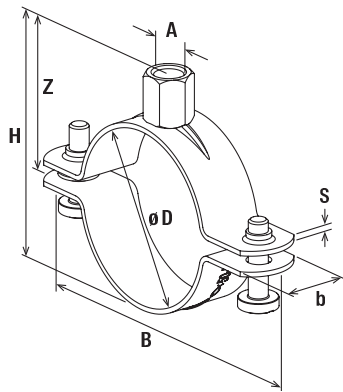

FRSN

Item	Item No.	Thread	Size	Clamping range	Width	Height	Width x thickness clamp band	Height Z	Locking screw	Max. recom. static load (centr. tension)	Sales unit
		A	[inch]	D [mm]	B [mm]	H [mm]	b x s [mm]	Z [mm]	N _{recom.} [kN]	[pcs]	
FRSN 15 - 19 M8/M10	049459	M 8 / M 10	3/8"	15 - 19	56	37	20 x 1,5	27	M 6	1.50	100
FRSN 21 - 23 M8/M10	049789	M 8 / M 10	1/2"	21 - 23	60	41	20 x 1,5	28	M 6	1.50	100
FRSN 25 - 28 M8/M10	049790	M 8 / M 10	3/4"	25 - 28	67	46	20 x 1,5	30	M 6	1.50	100
FRSN 32 - 36 M8/M10	049793	M 8 / M 10	1"	32 - 36	74	54	20 x 1,5	34	M 6	1.50	100
FRSN 38 - 43 M8/M10	049794	M 8 / M 10	1 1/4"	38 - 43	78	61	20 x 1,5	38	M 6	1.50	50
FRSN 44 - 49 M8/M10	049902	M 8 / M 10	1 1/2"	44 - 49	88	67	20 x 1,5	41	M 6	1.50	50
FRSN 50 - 56 M8/M10	049922	M 8 / M 10	—	50 - 56	92	74	20 x 1,5	43	M 6 x 16	1.50	50
FRSN 57 - 61 M8/M10	049944	M 8 / M 10	2"	57 - 61	98	79	20 x 1,5	47	M 6	1.50	50
FRSN 63 - 70 M8/M10	049945	M 8 / M 10	—	63 - 70	105	88	20 x 1,5	54	M 6	1.50	50
FRSN 70 - 77 M8/M10	049947	M 8 / M 10	2 1/2"	70 - 77	112	95	20 x 1,5	55	M 6	1.50	25
FRSN 80 - 83 M8/M10	049948	M 8 / M 10	—	80 - 83	116	101	20 x 1,5	58	M 6	1.50	25
FRSN 83 - 91 M8/M10	049979	M 8 / M 10	3"	83 - 91	128	111	20 x 2.0	63	M 6	2.50	25
FRSN 100 - 106 M8/M10	050006	M 8 / M 10	—	100 - 106	143	126	20 x 2.0	70	M 6	2.50	25
FRSN 108 - 114 M8/M10	050008	M 8 / M 10	4"	108 - 114	156	134	20 x 2.0	75	M 6	2.50	25
FRSN 123 - 128 M8/M10	050009	M 8 / M 10	—	123 - 128	173	149	25 x 2.5	82	M 6	2.50	25
FRSN 131 - 136 M8/M10	050010	M 8 / M 10	—	131 - 136	176	157	25 x 2.5	86	M 6	2.50	25
FRSN 137 - 146 M8/M10	050023	M 8 / M 10	5"	137 - 146	180	167	25 x 2.5	91	M 6	2.50	25
FRSN 118 - 122 M8/M10	500744	M 8 / M 10	—	118 - 122	160	142	20 x 2.0	78	M 6	2.50	25
FRSN 146 - 156 M8/M10	500746	M 8 / M 10	—	146 - 156	195	177	25 x 2.5	96	M 6	2.50	25
FRSN 159 - 165 M10/M12	500747	M 10 / M 12	—	159 - 165	203	191	25 x 2.5	106	M 6	2.50	25
FRSN 166 - 175 M10/M12	500748 ¹⁾	M 10 / M 12	—	166 - 175	211	201	25 x 2.5	110	M 8	2.50	20
FRSN 200 - 206 M10/M12	500751 ¹⁾	M 10 / M 12	—	200 - 206	248	232	25 x 2.5	126	M 8	2.50	10
FRSN 210 - 219 M10/M12	500752 ¹⁾	M 10 / M 12	8"	210 - 219	261	245	25 x 2.5	133	M 8	2.50	10

1) From diameter 166 mm the steel band is punched and delivered with separate locking screw and nut.

Heavy duty pipe clamp FRSM - inch

The large pipe clamp with sound insulation insert for medium to heavy loads

2a



Upright pipe on cantilever arm

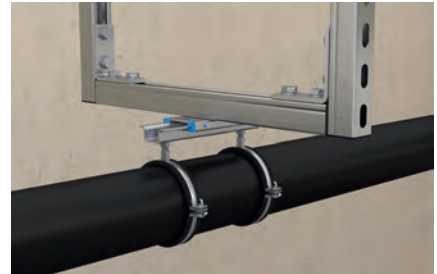

Pipe elongation with sliding element and suspended pipe

Applications

- Fixing of medium to heavy pipes with threaded rods (hanger bolts)

Advantages/benefits

- The inch threaded connecting nut allows for a pipe fixing with increased bending stress.
- High tested loads ensures the secure functioning of the FRSM.
- The sound insulation insert offers noise protection and prevents contact corrosion.
- The two screws allow an easy adjustment to suit the outer pipe diameter.
- The screw's safety feature ensures trouble-free installation.

Properties

- Material: steel DD11 (material no. 1.0332) acc. to DIN EN 10111
- Zinc plating: electro zinc-plated, 5 - 9 μm
- Connecting nut: 1/2" resistance welded
- Locking screw: flat head screw with combination recessed head
- Material sound insulation insert: EPDM; chlorine-free; silicone-free
- Temperature range: -50 °C to +110 °C
- Hardness: 45 \pm 5° Shore A
- Fire behaviour: DIN 4102: Class B2

Installation FRSM

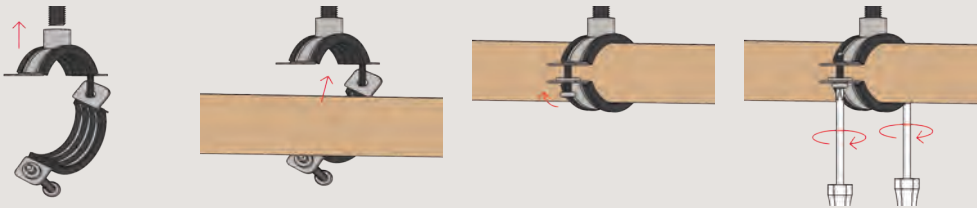

Technical data

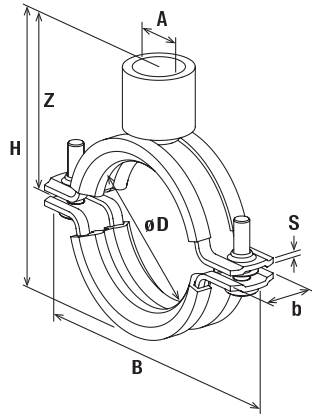

FRSM - Zoll

Item	Item No.	Thread	Size	Clamping range	Width	Height	Width x thickness clamp band	Height Z	Locking screw	Max. recom. static load (centr. tension) N _{recom.} [kN]	Sales unit [pcs]
		A	[inch]	D [mm]	B [mm]	H [mm]	b x s [mm]	Z [mm]			
FRSM 3/8"	535494	1/2"	3/8"	14 - 20	64.3	64	20 x 2.0	44.5	M 6	1.50	25
FRSM 1/2"	535497	1/2"	1/2"	21 - 26	70.6	70	20 x 2.0	47.5	M 6	1.50	25
FRSM 3/4"	535498	1/2"	3/4"	26 - 30	74.8	74	20 x 2.0	49.5	M 6	1.50	25
FRSM 1"	535499	1/2"	1"	31 - 38	81	80	20 x 2.0	52.5	M 6	1.50	25
FRSM 1 1/4"	535500	1/2"	1 1/4"	40 - 47	91.2	90	20 x 2.0	57.5	M 6	1.50	25
FRSM 1 1/2"	535501	1/2"	1 1/2"	48 - 54	100	98	20 x 2.0	61.5	M 6	1.50	25
FRSM 2"	535502	1/2"	2"	60 - 66	111.1	109	20 x 2.0	67	M 6	1.50	25
FRSM 2 1/2"	535503	1/2"	2 1/2"	73 - 80	131.4	123	25 x 2.5	74	M 8	3.15	10
FRSM 3"	535504	1/2"	3"	87 - 94	145.5	137	25 x 2.5	81	M 8	3.15	10
FRSM 110 mm	535505	1/2"	—	105 - 112	165.6	157	25 x 2.5	91	M 8	3.15	10
FRSM 4"	535506	1/2"	4"	112 - 118	171.7	163	25 x 2.5	94	M 8	3.15	10
FRSM 133 mm	535507	1/2"	—	132 - 137	190.8	182	25 x 2.5	103.5	M 8	3.15	10
FRSM 5"	535508	1/2"	5"	137 - 142	195.8	187	25 x 2.5	106	M 8	3.15	10
FRSM 160 mm	535509	1/2"	—	159 - 164	217.9	209	25 x 2.5	117	M 8	3.15	8
FRSM 6"	535511	1/2"	6"	164 - 169	222.9	214	25 x 2.5	119.5	M 8	3.15	8

Heavy duty pipe clamp FRSM - metric

The large pipe clamp with sound insulation insert for medium to heavy loads

2a



Heavy pipe on cantilever

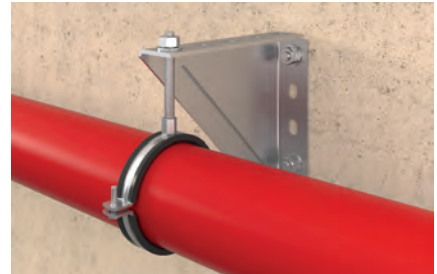

Heavy drainage pipe under angle bracket

Applications

- Fixing of medium to heavy pipes with threaded rods (hanger bolts)

Advantages/benefits

- High tested loads guarantee safe functioning of the FRSM.
- The combination connecting nut with thread M10/M12, M12/M16 or M16 allows for optimised mounting choices.
- From Ø 124 mm it is possible to install with 2 threaded rods, e.g. for the fixing of cast iron roof drainage pipes.
- The two screws allow for easy adjustment to suit the outer pipe diameter.
- The screw's safety features ensures trouble-free installation.

Properties

- Material: steel DD11 (material no. 1.0332) acc. to DIN EN 10111
- Zinc plating: electro zinc-plated, 5 - 9 µm
- Connecting nut: M10 / M12 = SW 17, M12 / M16 = SW 22, M16 = SW 24
- Locking screw: hexagon screw with nut
- Material sound insulation insert: EPDM; chlorine-free; silicone-free
- Temperature range: -50 °C to +110 °C
- Hardness: 45 ± 5° Shore A
- Fire behaviour: DIN 4102: Class B2

Installation FRSM

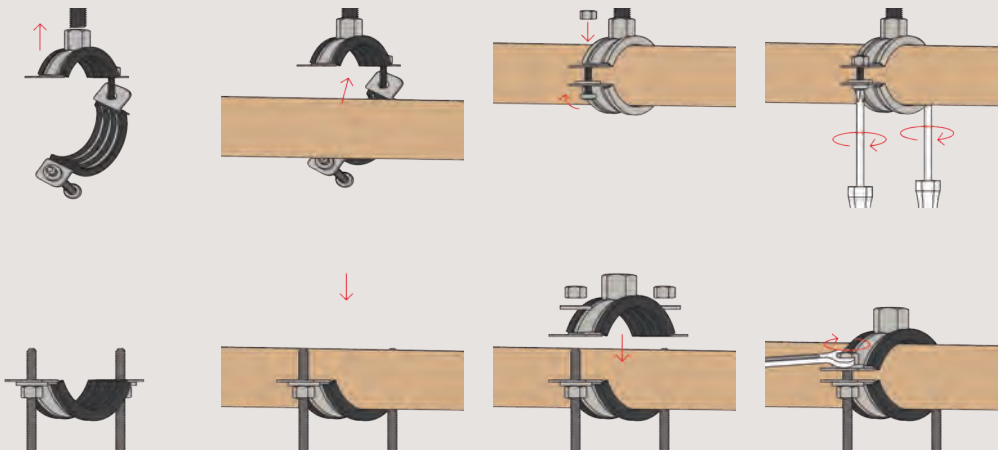

Technical data

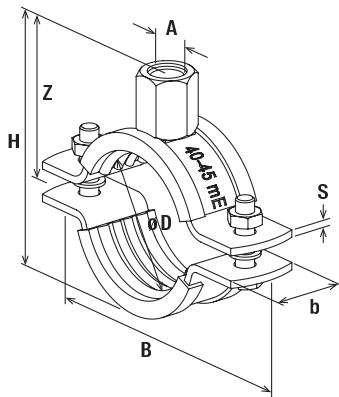

FRSM - metrisch

Item	Item No.	Thread	Size	Clamping range	Width	Height	Width x thickness clamp band	Height Z	Locking screw	Max. recom. static load (centr. tension) N _{recom.} [kN]	Sales unit [pcs]
		A	[inch]	D [mm]	B [mm]	H [mm]	b x s [mm]	Z [mm]			
FRSM 1/2" M10/M12	554243	M 10 / M 12	1/2"	19 - 23	77	56	25 x 2.5	38	M 6	2.50	50
FRSM 3/4" M10/M12	554244	M 10 / M 12	3/4"	24 - 29	83	62	25 x 2.5	41	M 6	2.50	50
FRSM 1" M10/M12	554245	M 10 / M 12	1"	33 - 36	91	69	25 x 2.5	45	M 6	2.50	50
FRSM 1 1/4" M10/M12	554246	M 10 / M 12	1 1/4"	40 - 45	100	78	25 x 2.5	49	M 6	2.50	20
FRSM 1 1/2" M10/M12	554247	M 10 / M 12	1 1/2"	47 - 52	107	85	25 x 2.5	53	M 6	2.50	20
FRSM 53 - 58 M10/M12	554248	M 10 / M 12	—	53 - 58	113	91	25 x 2.5	56	M 6	2.50	20
FRSM 2" M10/M12	554249	M 10 / M 12	2"	60 - 65	120	98	25 x 2.5	59	M 6	2.50	20
FRSM 2 1/2" M10/M12	554250	M 10 / M 12	2 1/2"	73 - 78	138	115	30 x 3,0	68	M 8	3.00	20
FRSM 79 - 85 M10/M12	554251	M 10 / M 12	—	79 - 85	145	122	30 x 3,0	71	M 8	3.00	20
FRSM 3" M10/M12	554252	M 10 / M 12	3"	88 - 93	153	130	30 x 3,0	75	M 8	3.00	20
FRSM 102 M10/M12	554253	M 10 / M 12	—	100 - 106	166	143	30 x 3,0	82	M 8	3.00	20
FRSM 4" M10/M12	554254	M 10 / M 12	4"	108 - 116	176	153	30 x 3,0	87	M 8	3.00	20
FRSM 124 - 129 M10/M12	093709	M 10 / M 12	—	124 - 129	190	164	30 x 3,0	92	M 8	3.00	20
FRSM 131 - 137 M10/M12	093710	M 10 / M 12	—	131 - 137	198	172	30 x 3,0	96	M 8	3.00	20
FRSM 138 - 145 M10/M12	093711	M 10 / M 12	5"	138 - 145	205	180	30 x 3,0	100	M 8	3.00	20
FRSM 156 - 162 M10/M12	093712	M 10 / M 12	—	156 - 162	223	197	30 x 3,0	108	M 8	3.00	20
FRSM 165 - 171 M10/M12	093713	M 10 / M 12	6"	165 - 171	232	206	30 x 3,0	113	M 8	3.00	20
FRSM 177 - 183 M10/M12	558303	M 10 / M 12	—	177 - 183	245	222	30 x 3,0	121	M 8	3.0	20
FRSM 188 - 194 M10/M12	093714	M 10 / M 12	7"	188 - 194	255	229	30 x 3,0	124	M 8	3.00	10
FRSM 196 - 203 M10/M12	093715	M 10 / M 12	—	196 - 203	263	238	30 x 3,0	129	M 8	3.00	10
FRSM 212 M12/M16	505453	M 12 / M 16	—	205 - 214	297	264	40 x 4,0	147	M 12	5.00	10
FRSM 8" M12/M16	505454	M 12 / M 16	8"	219 - 225	308	275	40 x 4,0	153	M 12	5.00	10
FRSM 250 M12/M16	505455	M 12 / M 16	—	244 - 250	333	300	40 x 4,0	165	M 12	5.00	10
FRSM 10" M12/M16	505456	M 12 / M 16	10"	267 - 273	356	323	40 x 4,0	177	M 12	5.00	10
FRSM 277 - 283 M12/M16	558304	M 12 / M 16	—	277 - 283	367	334	—	180	M 12	5.00	10
FRSM 300 M12/M16	505457	M 12 / M 16	—	297 - 304	387	354	40 x 4,0	192	M 12	5.00	10
FRSM 305 - 316 M12/M16	552858	M 12 / M 16	—	305 - 316	397	366	40 x 4,0	198	M 12	5.00	10
FRSM 12" M12/M16	505458	M 12 / M 16	12"	320 - 328	411	378	40 x 4,0	204	M 12	5.00	10
FRSM 348 - 356 M16	504594	M 16	—	348 - 356	480	403	50 x 5,0	213	M 16	8.00	1
FRSM 364 - 372 M16	504595	M 16	—	364 - 372	496	419	50 x 5,0	221	M 16	8.00	1
FRSM 400 - 409 M16	504596	M 16	—	400 - 409	533	456	50 x 5,0	240	M 16	8.00	1
FRSM 454 - 462 M16	504597	M 16	—	454 - 462	586	509	50 x 5,0	266	M 16	8.00	1
FRSM 500 - 508 M16	504598	M 16	—	500 - 508	632	555	50 x 5,0	290	M 16	8.00	1

Refrigeration pipe clamp FRS K

The two-screw refrigeration pipe clamp with integrated insulation

2a



Refrigerant pipe clamps

Applications

- Installation of pipes in refrigeration and air-conditioning applications

Advantages/benefits

- The self-adhesive material ensures easy installation of the refrigeration pipe clamp.
- Age-resistant material ensures a long life of the FRS-K.
- The double-threaded connection nut allows for flexibility during the installation.
- The screw's safety feature ensures trouble-free installation.
- The integrated load distribution sheet guarantees the load transmission and allows higher loads.

Properties

- Material: polyurethan-foam, silicone-free
- Diffusion resistance: 7000 μ
- Density: 80 kg/m³
- Compressive strength: 0,67-0,75 mPa
- Heat conductivity (at 0 °C): 0,024-0,026 W/mK
- Locking screw: flat head screw with combination recessed head
- Temperature range: -45 °C to +105 °C
- Fire behaviour: DIN 4102: Class B2

Technical data

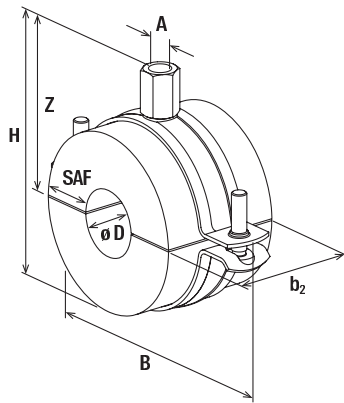

FRS K

Item	Item No.	Size	Thread	Insulation thickness	Width	Height	Height Z	Locking screw	Length of insulation material b ₂ [mm]	Max. recom. static load (centr. tension) N _{recom.} [kN]	Sales unit [pcs]
		[inch]	A	S _{AF} [mm]	B [mm]	H [mm]	Z [mm]				
FRS K 12/13	506486	—	M 8 / M 10	13	77	59	33	M 6	50	0.10	1
FRS K 15/13	506487	1/4"	M 8 / M 10	13	85	64	37	M 6	50	0.11	1
FRS K 17-18/13	506488	3/8"	M 8 / M 10	13	86	64	37	M 6	50	0.12	1
FRS K 21-22/13	506489	1/2"	M 8 / M 10	13	90.5	69	40	M 6	50	0.13	1
FRS K 27-28/13	506490	3/4"	M 8 / M 10	13	98.5	78	46	M 6	50	0.15	1
FRS K 34-35/13	506491	1"	M 8 / M 10	13	105	83	49	M 6	50	0.17	1
FRS K 48-49/13	506493	1 1/2"	M 8 / M 10	13	118	102	56	M 6	50	0.39	1
FRS K 42/13	506492	1 1/4"	M 8 / M 10	13	115	96	53	M 6	50	0.36	1
FRS K 54/13	507699	—	M 8 / M 10	13	125	107	59	M 8	50	0.42	1
FRS K 60/13	506494	2"	M 8 / M 10	13	132	115	63	M 6	50	0.45	1
FRS K 12/19	506495	—	M 8 / M 10	19	90	71	41	M 6	50	0.14	1
FRS K 15/19	506496	1/4"	M 8 / M 10	19	90.5	74	42	M 6	50	0.15	1
FRS K 17-18/19	506497	3/8"	M 8 / M 10	19	99	77	44	M 6	50	0.15	1
FRS K 21-22/19	506498	1/2"	M 8 / M 10	19	99	77	44	M 6	50	0.16	1
FRS K 27-28/19	506499	3/4"	M 8 / M 10	19	106	90	50	M 6	50	0.18	1
FRS K 34-35/19	506500	1"	M 8 / M 10	19	115	97	53	M 6	50	0.20	1
FRS K 42/19	506501	1 1/4"	M 8 / M 10	19	125	109	59	M 6	50	0.42	1
FRS K 48-49/19	506502	1 1/2"	M 8 / M 10	19	132	116	62.5	M 6	50	0.45	1
FRS K 54/19	507700	—	M 8 / M 10	19	143	123	65.5	M 8	50	0.48	1
FRS K 60/19	506503	2"	M 8 / M 10	19	147	129	69	M 6	50	0.51	1
FRS K 64/19	506504	—	M 8 / M 10	19	149	134	71	M 6	50	0.53	1
FRS K 70/19	506505	—	M 8 / M 10	19	161	142	75	M 6	50	0.56	1
FRS K 76/19	506506	2 1/2"	M 8 / M 10	19	162.5	147	77	M 6	50	0.60	1
FRS K 89/19	506508	3"	M 8 / M 10	19	188	165	86.5	M 8	50	0.66	1
FRS K 102/19	506509	—	M 8 / M 10	19	199	180	94.5	M 8	100	1.69	1
FRS K 108/19	506510	—	M 8 / M 10	19	204	185	97	M 8	100	1.77	1
FRS K 114/19	506511	4"	M 12 / M 16	19	241	201	112	M 12	100	1.84	1
FRS K 133/19	507786	—	M 12 / M 16	19	270	221	122	M 12	100	2.07	1
FRS K 139/19	507787	5"	M 12 / M 16	19	270	227	125	M 12	100	2.14	1
FRS K 168/19	507788	6"	M 12 / M 16	19	281	256	139	M 12	100	2.49	1
FRS K 219/19	539477	8"	M 12 / M 16	19	346	290	156.6	M 12	100	2.94	1

Refrigeration pipe clamp KFT

The two-screw refrigeration pipe clamp made from closed PUR foam

2a



Refrigerant pipe clamps

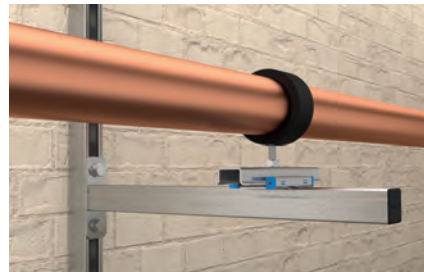

Refrigerant pipe clamp on sliding element

Applications

- Installation of pipes in refrigeration and air-conditioning applications with high loads

Advantages/benefits

- The refrigeration pipe clamp KFT made from closed PUR foam can be used with all standard insulation materials.
- The glued rubber overlay makes the installation easier.
- The triple-threaded connection nut M8 / M10 / 1/2" allows for flexibility during the installation.
- Age-resistant material ensures the long-term functionality of the KFT.
- The two screws allow an easy adjustment to suit the outer pipe diameter.

Properties

- Material: closed-cell polyurethane foam, silicone-free
- Diffusion resistance: 1000 μ
- Density: 250 kg/m³
- Compression strength: 3,96 mPa at 23 °C
- Heat conductivity (at 0 °C): 0,049 W/(m*K)
- Temperature range: -160 °C to +130 °C
- Fire behaviour: DIN 4102: Class B2

Installation KFT

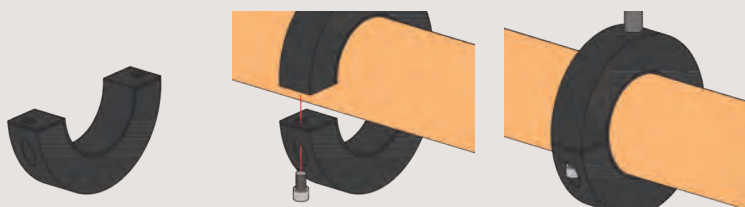

Technical data

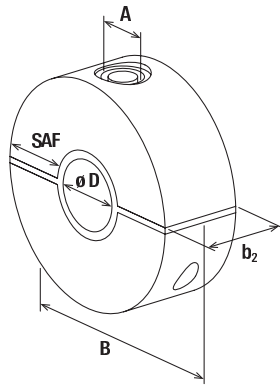

KFT

Item	Item No.	Thread	Internal diameter	Width	Locking screw	Insulation thickness	Length of insulation material	Max. recom. static load (centr. tension)	Sales unit
		A	D [mm]	B [mm]		S _{AF} [mm]	b ₂ [mm]	N _{recom.} [kN]	
KFT 9,5	505576	¹⁾ M 8 / M 10 / 1/2"	9,5	88	M 6	30	40	0.15	1
KFT 12,7	505577	M 8 / M 10 / 1/2"	12,7	88	M 6	30	40	0.20	1
KFT 15,8	505578	M 8 / M 10 / 1/2"	15,8	88	M 6	30	40	0.21	1
KFT 17,2	505579	¹⁾ M 8 / M 10 / 1/2"	17,2	88	M 6	30	40	0.21	1
KFT 18,0	505580	M 8 / M 10 / 1/2"	18,0	88	M 6	30	40	0.21	1
KFT 19,5	505581	¹⁾ M 8 / M 10 / 1/2"	19,5	88	M 6	30	40	0.21	1
KFT 21,3	505582	M 8 / M 10 / 1/2"	21,3	88	M 6	30	40	0.26	1
KFT 22,0	505583	M 8 / M 10 / 1/2"	22,0	88	M 6	30	40	0.26	1
KFT 26,9	505584	M 8 / M 10 / 1/2"	26,9	88	M 6	30	40	0.32	1
KFT 28,0	505585	M 8 / M 10 / 1/2"	28,0	88	M 6	30	40	0.32	1
KFT 33,7	505587	M 8 / M 10 / 1/2"	33,7	96	M 6	30	40	0.40	1
KFT 35,0	505588	M 8 / M 10 / 1/2"	35,0	96	M 6	30	40	0.42	1
KFT 40,0	505589	¹⁾ M 8 / M 10 / 1/2"	40,0	100	M 6	30	40	0.42	1
KFT 41,2	505591	¹⁾ M 8 / M 10 / 1/2"	41,2	100	M 6	30	40	0.51	1
KFT 42,4	505592	M 8 / M 10 / 1/2"	42,4	103	M 6	30	40	0.51	1
KFT 44,5	505593	¹⁾ M 8 / M 10 / 1/2"	44,5	103	M 6	30	40	0.51	1
KFT 48,3	505594	M 8 / M 10 / 1/2"	48,3	102	M 6	30	40	0.58	1
KFT 50,0	505595	¹⁾ M 8 / M 10 / 1/2"	50,0	112	M 6	30	40	0.60	1
KFT 54,0	505596	M 8 / M 10 / 1/2"	54,0	116	M 6	30	40	0.62	1
KFT 57,0	505597	M 8 / M 10 / 1/2"	57,0	116	M 6	30	40	0.65	1
KFT 60,3	505598	M 8 / M 10 / 1/2"	60,3	123	M 6	30	50	0.72	1
KFT 64,0	505599	M 8 / M 10 / 1/2"	64,0	123	M 6	30	50	0.77	1
KFT 70,0	505901	M 8 / M 10 / 1/2"	70,0	132	M 8	30	50	1.26	1
KFT 74,0	505902	¹⁾ M 8 / M 10 / 1/2"	74,0	132	M 8	30	50	1.26	1
KFT 76,1	505903	M 8 / M 10 / 1/2"	76,1	132	M 8	30	50	1.37	1
KFT 80,0	505904	¹⁾ M 8 / M 10 / 1/2"	80,0	132	M 8	30	50	1.37	1
KFT 84,0	505905	¹⁾ M 8 / M 10 / 1/2"	84,0	150	M 8	30	50	1.60	1
KFT 88,9	505906	M 8 / M 10 / 1/2"	88,0	150	M 8	30	50	1.60	1
KFT 92,1	505907	¹⁾ M 8 / M 10 / 1/2"	92,1	150	M 8	30	50	1.60	1
KFT 101,0	505908	¹⁾ M 8 / M 10 / 1/2"	101,0	188	M 8	40	60	2.59	1
KFT 104,0	505909	¹⁾ M 8 / M 10 / 1/2"	104,0	188	M 8	40	60	2.59	1
KFT 108,0	505910	M 8 / M 10 / 1/2"	108,0	188	M 8	40	60	2.59	1
KFT 114,3	505911	M 8 / M 10 / 1/2"	114,3	195	M 8	40	60	2.74	1
KFT 129,0	505914	¹⁾ M 8 / M 10 / 1/2"	129,0	220	M 8	40	60	3.19	1
KFT 133,0	505915	M 8 / M 10 / 1/2"	133,0	220	M 8	40	60	3.19	1
KFT 139,7	505916	M 8 / M 10 / 1/2"	139,7	220	M 8	40	60	3.35	1
KFT 154,0	505917	¹⁾ M 12 / 1/2"	154,0	239	M 10	40	60	3.83	1
KFT 159,0	505918	M 12 / 1/2"	159,0	239	M 10	40	60	3.83	1
KFT 168,3	505919	M 12 / 1/2"	168,3	250	M 10	40	60	4.04	1
KFT 193,7	505920	¹⁾ M 16 / 1/2"	193,7	340	M 10	60	100	5.26	1

1) delivery on request

Technical data

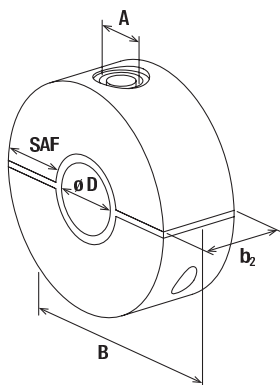

KFT

Item	Item No.	Thread	Internal diameter	Width	Locking screw	Insulation thickness	Length of insulation material	Max. recom. static load (centr. tension)	Sales unit [pcs]
		A	D [mm]	B [mm]		S _{AF} [mm]	b ₂ [mm]	N _{recom.} [kN]	
KFT 204,0	505921 ¹⁾	M 16 / 1/2"	204,0	340	M 10	60	100	5.20	1
KFT 219,1	505922	M 16 / 1/2"	219,1	340	M 10	60	100	5.26	1
KFT 273	552859	M20 / 3/4"	273	393	M 16	60	100	7.00	1
KFT 323,9	552860	M20 / 3/4"	323,9	444	M 16	60	100	7.00	1

1) delivery on request

Sprinkler clamp FRSP

The flexible sprinkler loop with FM and UL approval



Sprinkler pipe installation

Applications

- Installation of sprinkler pipes
- Used for the suspension of stationary, non-insulated pipelines

Certificates



from M10

Advantages/benefits

- For easy installation of sprinkler pipes from 1/2" to 8" for a wide range of applications.
- Simple assembly by inserting, hanging and adjusting the pipes. Saves time during installation.
- Simple height adjustment by means of a height-adjustable connecting nut.
- The sprinkler clamp has FM and UL approval ensuring safe application.

Properties

- Material: steel Q235B
- Zinc plating: electro zinc-plated, min. 5 µm

Installation FRS P

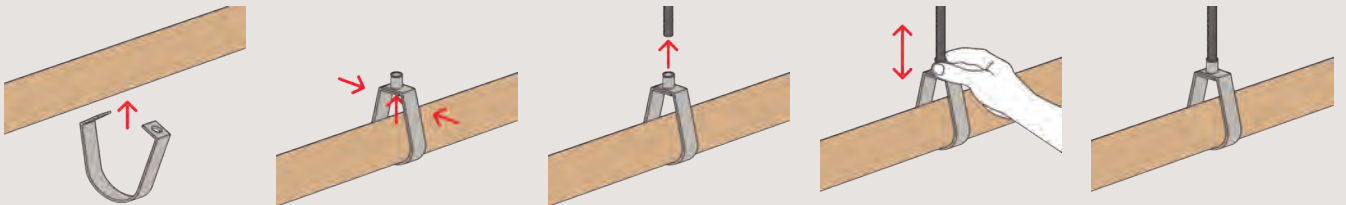

Technical data

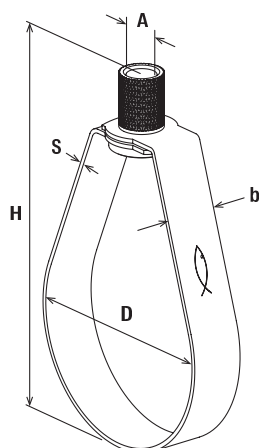

2a

FRSP

Item	Item No.	FM approved	UL approved	Size [inch]	Thread Ø x length [mm]	Height H [mm]	Width x thick- ness clamp band b x s [mm]	Max. recom. static load (centr. tension) N _{recom.} [kN]	Sales unit [pcs]
FRSP 1/2"	516662	—	X	1/2"	M 10 x 22,5	55	16 x 1,2	1.50	100
FRSP 3/4"	516663	X	X	3/4"	M 10 x 22,5	62	16 x 1,2	1.50	100
FRSP 1"	516664	X	X	1"	M 10 x 22,5	70	16 x 1,2	1.50	100
FRSP 1-1/4"	516665	X	X	1 1/4"	M 10 x 22,5	78	16 x 1,2	1.50	100
FRSP 1-1/2"	516666	X	X	1 1/2"	M 10 x 22,5	83	16 x 1,2	1.50	100
FRSP 2"	516667	X	X	2"	M 10 x 22,5	93	16 x 1,2	1.50	100
FRSP 2-1/2"	516668	X	X	2 1/2"	M 10 x 22,5	126	19 x 2,2	5.50	60
FRSP 3"	516669	X	X	3"	M 10 x 22,5	147	19 x 2,2	5.50	60
FRSP 4"	516670	X	X	4"	M 10 x 22,5	180	19 x 2,2	5.50	24
FRSP 5"	532356	X	X	5"	M 12 x 26,8	210	19 x 2,5	6.50	24
FRSP 6"	516671	X	X	6"	M 12 x 26,8	251	19 x 3,0	6.50	24
FRSP 8"	516672	X	X	8"	M 12 x 26,8	301	19 x 3,0	6.50	12

Sprinkler clamp FRSL

The premium sprinkler loop with separable band and height adjustment, VdS approved



Sprinkler pipe installation

2a

Applications

- Installation of sprinkler pipes according VdS

Certificates



G 410037 / G 410034

Advantages/benefits

- The VdS approval guarantees independently tested safety for the use in sprinkler systems.
- The adjustment nut enables a simple, post-installation height adjustment of the pipes.

Properties

- Material pipe loop: steel DX51D acc. to DIN EN 10346, material no. 1.0226 (Z140 N-A-C)
- Material adjustment nut: steel 11 SMn-Pb 30 acc. to DIN EN 10087, material no. 1.0718
- Zinc plating: sendzimir-galvanised, min. 8 µm

Installation FRSL

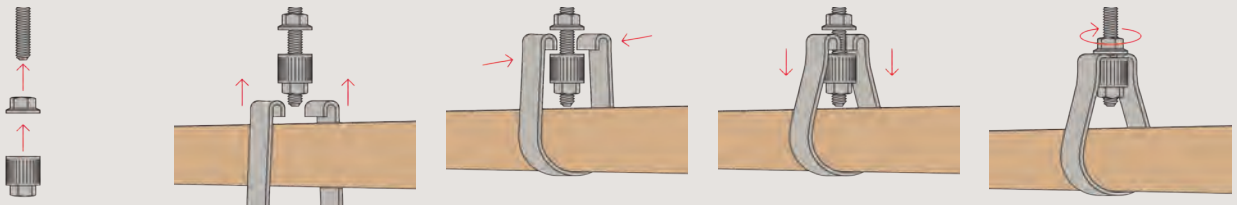

Technical data

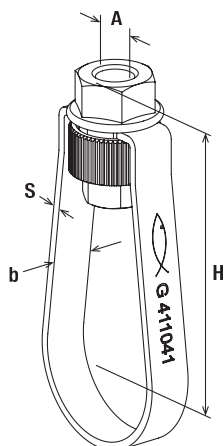

FRSL

Item	Item No.	VdS approved	Size [inch]	Thread A	Height		Width x thick- ness clamp band b x s [mm]	Max. recom. static load (centr. tension) N _{recom.} [kN]	Sales unit [pcs]
					H	[mm]			
FRSL 34 M8	538082	X	1"	M 8	67		10 x 1,8	2.0	50
FRSL 43 M8	538083	X	1 1/4"	M 8	67		10 x 1,8	2.0	50
FRSL 49 M8	538084	X	1 1/2"	M 8	72		10 x 1,8	2.0	50
FRSL 60 M8	538085	X	2"	M 8	81		10 x 1,8	2.0	50
FRSL 34	513302	X	1"	M 10	67		10 x 1,8	2.0	50
FRSL 43	513303	X	1 1/4"	M 10	67		10 x 1,8	2.0	50
FRSL 49	513304	X	1 1/2"	M 10	72		10 x 1,8	2.0	50
FRSL 60	513307	X	2"	M 10	81		10 x 1,8	2.0	50
FRSL 76	513308	X	2 1/2"	M 10	98		10 x 2,5	3.5	25
FRSL 90	513309	X	3"	M 10	113		10 x 2,5	3.5	25
FRSL 115	513310	X	4"	M 10	143		10 x 2,5	3.5	25
FRSL 140	513311	X	5"	M 12	157		13 x 2,5	5.0	25
FRSL 170	513312	X	6"	M 12	187		13 x 2,5	5.0	25

Sprinkler clamp FCHS

The universal sprinkler loop with FM and UL approval

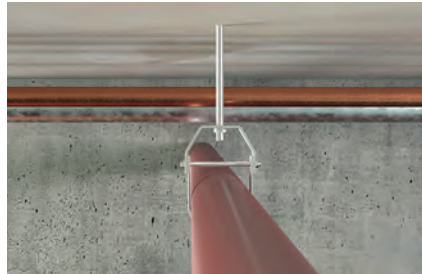

Sprinkler pipe installation

2a

Applications

- Installation of sprinkler pipes
- Used for the suspension of stationary, non-insulated pipelines

Certificates



from M10

Advantages/benefits

- For easy installation of sprinkler lines from 1/2" to 12" for a wide range of applications.
- Swivel clamp band to absorb movements sprinkler system.
- The sprinkler clamp has FM and UL approval ensuring safe application.

Properties

- Material: steel Q235B
- Zinc plating: electro zinc-plated, min. 5 µm

Installation FCHS

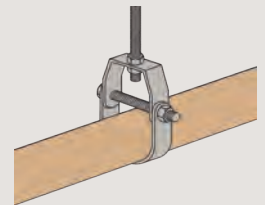
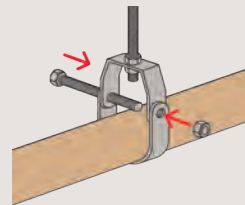
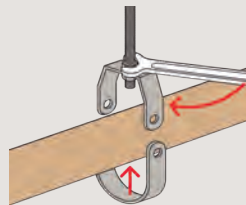

Technical data

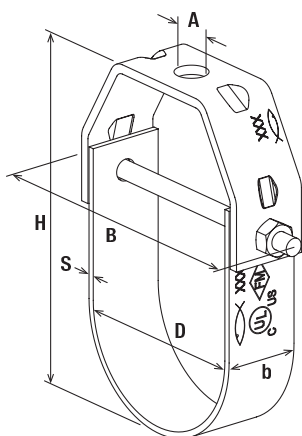

2a

FCHS

Item	Item No.	FM approved	UL approved	Size [inch]	Hole-Ø	Clamping range D [mm]	Height H [mm]	Width B [mm]	Width x thickness clamp band b x s [mm]	Max. recom. static load (centr. tension) N _{recom.} [kN]	Sales unit [pcs]
					D [mm]						
FCHS 1/2"	532187	X	X	1/2"	10.5	19 - 23	51	49	19 x 2,0	3.00	100
FCHS 3/4"	532190	X	X	3/4"	10.5	24 - 29	58	55	19 x 2,0	3.00	100
FCHS 1"	532195	X	X	1"	10.5	33 - 37	70	61	19 x 2,0	3.00	100
FCHS 1-1/4"	532197	X	X	1 1/4"	10.5	40 - 45	84	74	25 x 2,0	3.00	100
FCHS 1-1/2"	532198	X	X	1 1/2"	10.5	47 - 52	100	80	25 x 2,0	3.00	50
FCHS 2"	516695	X	X	2"	10.5	60 - 65	114	93	25 x 2,0	3.00	50
FCHS 2-1/2"	516696	X	X	2 1/2"	13.5	73 - 78	133	107	30 x 2,5	5.00	50
FCHS 3"	516697	X	X	3"	13.5	88 - 93	153	126	30 x 2,5	5.00	25
FCHS 4"	516699	X	X	4"	16.8	108 - 116	192	158	30 x 3,0	5.00	25
FCHS 5"	516700	X	X	5"	16.8	138 - 145	238	213	30 x 4,0	6.00	15
FCHS 6"	516701	X	X	6"	20.5	165 - 172	272	248	38 x 5,0	9.00	10
FCHS 8"	516702	X	X	8"	20.5	219 - 225	333	305	38 x 5,0	9.00	6
FCHS 10"	516703	—	—	10"	24	267 - 273	400	372	50 x 6,0	16.00	2
FCHS 12"	516704	—	—	12"	24	320 - 328	479	426	50 x 6,0	16.00	2

Riser clamp RCWR

RCWR riser pipe clamps for secure fixing of vertical riser pipes with UL certification.



Floorcrossing Downpipe

2a

Applications

- Secure fixing of vertical pipelines
- For use in dry interior areas

Certificates



Advantages/benefits

- Usable for all kinds of pipes
- Suitable sizes for pipe diameters of 1/2" to 8"
- Easy installation using hexagonal screws and nuts
- Safe for use thanks to UL certification

Properties

- Material: steel Q235B
- Zinc plating: electro zinc-plated, min. 5 µm

Installation RCWR

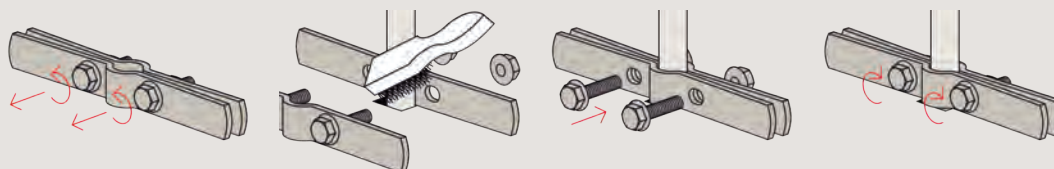

Technical data

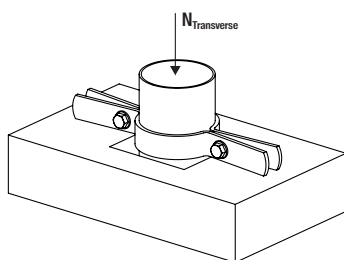
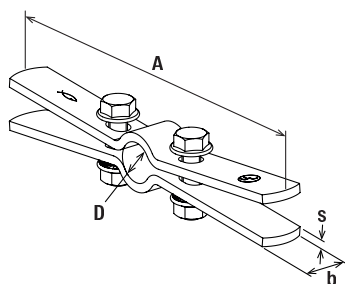

RCWR

Item	Item No.	UL approved	Clamping range	Width A	Width x thick- ness clamp band	Max. recom. transverse tensile load	Tightening torque screw	Sales unit
			D [mm]	A [mm]	b x s [mm]	$N_{\text{transverse}}$ [kN]	[Nm]	[pcs]
RCWR 1/2"	516673	X	22	215	25 x 5,0	3.30	25	35
RCWR 3/4"	516674	X	28	229	25 x 5,0	3.30	25	30
RCWR 1"	516675	X	34	230	25 x 5,0	3.30	25	25
RCWR 1 1/4"	516676	X	43	241	25 x 5,0	3.30	25	25
RCWR 1 1/2"	516677	X	49	251	25 x 3,0	3.30	25	25
RCWR 2"	516678	X	62	262	30 x 5,0	3.30	25	25
RCWR 2 1/2"	532380	X	75	281	30 x 5,0	3.70	25	25
RCWR 3"	516679	X	91	299	30 x 5,0	4.60	25	20
RCWR 4"	516680	X	116	329	38 x 6,0	6.60	60	12
RCWR 5"	516681	X	144	362	38 x 6,0	8.90	60	12
RCWR 5"	516682	X	171	394	50 x 6,0	11.50	60	8
RCWR 8"	516683	X	223	464	50 x 9,5	18.00	100	4

U-Clamp FUBD

The easy handling pipe and cable clamp for direct attachment of lines to FUS mounting rails



Supply lines fixed to FUS channel

2a

Applications

- Fast installation of metal and plastic pipes, flexible plastic pipes or cables without sound insulation requirements directly to FUS installation channels
- Fits to FUS channels FUS 21, FUS 41, FUS 62, FUS 21D, FUS 41D, FUS 62D

Advantages/benefits

- The FUBD without soundproofing is ideal for use in industrial applications, for example, for fixing lightweight flexible supply lines in the immediate area of production machines.
- Locking screw with hexagonal and slot drive.
- Quick adaptation to the desired outside pipe diameter by fastening the pressure pan.
- No loss of parts due to preassembled parts.
- Time- and cost-saving installation without the need of accessories like threaded rods or sliding nuts.

Properties

- Material U-Strap: steel S235JRC (Werkstoff-Nr.: 1.0122) acc. to EN 10025
- Zinc plating U-Strap: hot-dip galvanised min. 35 µm acc. to DIN EN ISO 1461
- Material Pressure pan: steel DX51D acc. to DIN EN 10346
- Zinc plating Pressure pan: electro zinc plated, min. 5 µm acc. to DIN EN ISO 4042
- Material Locking screw: steel 4.6 acc. to EN 20898-1
- Locking screw: with hexagonal SW10 and slot head

Installation FUBD

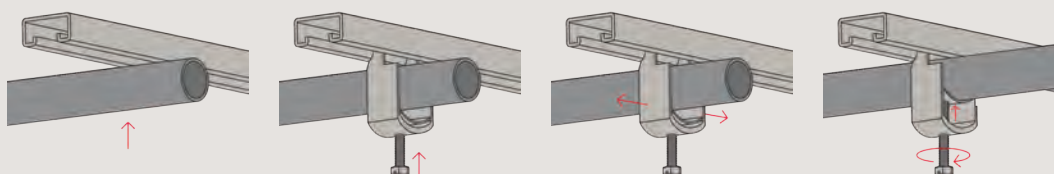

Technical data

2a

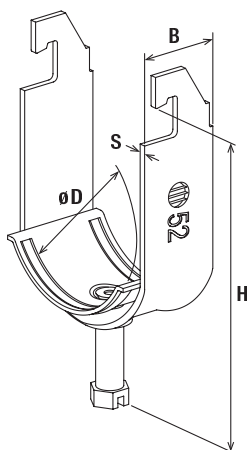

FUDB

Item	Item No.	Clamping range	Height	Width x thickness clamp band	Locking screw	Sales unit
		D [mm]	H [mm]	b x s [mm]		[pcs]
FUBD 40	539564 ¹⁾	36 - 40	71	25 x 1,75	M 6 x 24	100
FUBD 48	558148	44 - 48	85	25 x 2,0	M 8 x 30	50
FUBD 52	539566	48 - 52	90	25 x 2,0	M 8 x 30	50
FUBD 60	539567 ¹⁾	56 - 60	98	30 x 2,25	M 8 x 30	50
FUBD 76	539568 ¹⁾	70 - 76	113	30 x 2,75	M 8 x 30	25
FUBD 94	539569 ¹⁾	88 - 94	141	30 x 2,75	M8 x 40	20
FUBD 100	539570 ¹⁾	94 - 100	147	30 x 2,75	M8 x 40	10

1) Delivery time on request.

U-bolt ETR

The U-bolt with metric thread



Applications

- Installation of standing or hanging pipes
- Pipe routing on profiles and consoles

Advantages/benefits

- The U-bolt's two screws allow an ideal adaptation to suit the outer pipe diameter.

Properties

- Material: steel with min. tensile strength of 360 N/mm²
- Zinc plating: electro zinc-plated

Technical data

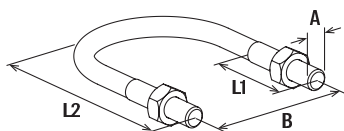

ETR

Item	Item No.	Thread A	Length L ₁ [mm]	Length L ₂ [mm]	Size [inch]	Width B [mm]	Sales unit [pcs]
ETR 8 - 13	024415	M 6	30	20	1/4"	20	10
ETR 12 - 17	024416	M 6	35	20	3/8"	24	10
ETR 15 - 21	024417	M 6	40	25	1/2"	28	10
ETR 20 - 27	024418	M 8	50	32	3/4"	36	10
ETR 26 - 34	024419	M 8	55	32	1"	43	10
ETR 33 - 42	024420	M 8	68	38	1 1/4"	51	10
ETR 40 - 49	024421	M 8	70	38	1 1/2"	58	10
ETR 50 - 60	024422	M 8	80	40	2"	69	10
ETR 60 - 70	024423	M 10	100	43	—	82	10
ETR 66 - 76	024424	M 10	110	50	2 1/2"	88	10
ETR 70 - 82	024425	M 10	115	50	—	94	10
ETR 80 - 90	024426	M 10	115	50	3"	102	10
ETR 90 - 102	024427	M 12	145	55	3 1/2"	116	5
ETR 100 - 108	024428	M 12	150	50	—	122	5
ETR 102 - 114	024429	M 12	156	60	4"	128	5
ETR 121 - 127	024430	M 12	170	60	—	141	5
ETR 126 - 133	024431	M 12	180	70	—	147	5
ETR 131 - 140	024432	M 14	185	70	5"	156	5
ETR 143 - 153	024433	M 14	193	70	—	169	5
ETR 150 - 159	024434	M 14	200	70	—	175	5
ETR 168	024435	M 14	210	70	6"	184	5
ETR 193,7	024436	M 14	232	70	—	209	5
ETR 219	024437	M 14	270	70	8"	236	5

Hose clamp SGS

The hose clamp for large hoses, pipe or ducting

2a



Applications

- Sealing of hoses
- Fixing hoses to adapters

Advantages/benefits

- The crimped band edges offer protection against damage to the hose.
- The short base of the hosing allows an ideal adjustment and high, radial forces on the hose diameter.
- The screw's combination cross-drive thread enables installation flexibility.

Properties

- Material class: W 2
- Worm: CQ 15 (material no. 1.1132) acc. to DIN EN 10263
- Housing and band: chromium steel (material no. 1.4016) acc. to DIN EN 10088 or equivalent corrosion-resistant steel

Technical data

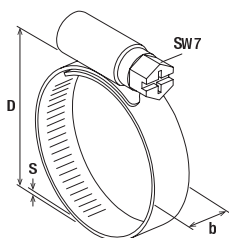

SGS

Item	Item No.	Clamping range D [mm]	Width x thickness clamp band b x s [mm]	Sales unit [pcs]
SGS 9 W2 8 - 12	045517	8 - 12	9,0 x 0,6	100
SGS 9 W2 10 - 16	045518	10 - 16	9,0 x 0,6	100
SGS 9 W2 12 - 20	045519	12 - 20	9,0 x 0,6	100
SGS 9 W2 16 - 27	045520	16 - 27	9,0 x 0,6	100
SGS 9 W2 20 - 32	045521	20 - 32	9,0 x 0,6	100
SGS 9 W2 25 - 40	045522	25 - 40	9,0 x 0,6	100
SGS 9 W2 32 - 50	045523	32 - 50	9,0 x 0,6	100
SGS 9 W2 40 - 60	045524	40 - 60	9,0 x 0,6	25
SGS 9 W2 50 - 70	045525	50 - 70	9,0 x 0,6	25
SGS 9 W2 60 - 80	045526	60 - 80	9,0 x 0,6	25
SGS 9 W2 70 - 90	045527	70 - 90	9,0 x 0,6	25
SGS 9 W2 80 - 100	045528	80 - 100	9,0 x 0,6	25
SGS 9 W2 90 - 110	045529	90 - 110	9,0 x 0,6	25
SGS 9 W2 100 - 120	045530	100 - 120	9,0 x 0,6	25
SGS 9 W2 110 - 130	045531	110 - 130	9,0 x 0,6	25
SGS 9 W2 120 - 140	045532	120 - 140	9,0 x 0,6	25

2b

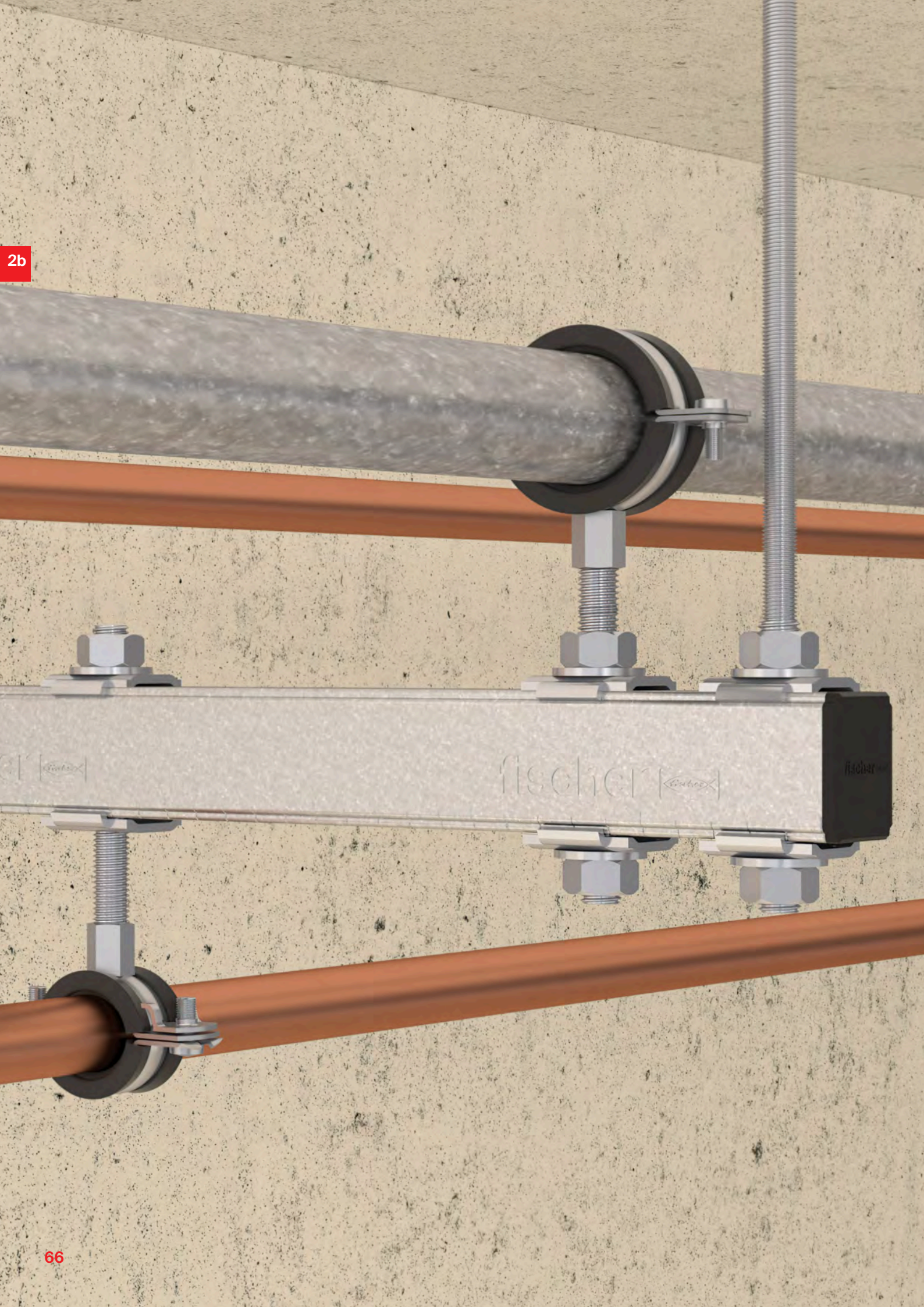

2b

Light channel system FLS

Channel FLS	68	
FLS Cutting Tool	71	
Cantilever arm ALK	73	
Angle brace WS 31-45°	76	
Channel connector SV 31	78	
Sliding channel nut FSM Clix P	80	
Sliding channel nut FSM Clix M	82	
T-head bolt FHS Clix	84	
Saddle flange SF Clix 31	86	
Angle bracket MW Clix 90°	88	
Angle bracket MW and MWU	90	
Channel washer HK 31	92	
Beam clamp TKR 31	93	

Channel FLS

The flexible channel system for light applications

2b



Air duct fixing with channel

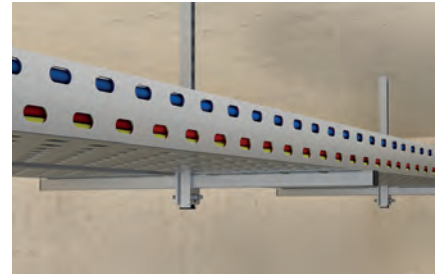

Suspended cable tray fixing

Applications

- The U-profile channels enable the creation of secure, horizontal and vertical installations.
- The channel system is suitable for fast and efficient fixings of pipelines and supporting structures.

Certificates



Fire resistance classification
R120



MLAR R30

Advantages/Benefits

- The fire inspection report in line with MLAR/EN1363-1 of the FLS 37 guarantees independently tested functional safety.
- The channel shape with edge seams gives a perfect fit for the connector elements and leads to a safe and easy installation.
- The serration with stamped teeth in the mounting channel gives the sliding nuts a secure hold to bear high shear loads.
- The scale on the channels simplifies the cutting of the channels and the positioning of the connector elements during installation.
- The alternating long slots in the channel enable the optimised fixing to the substrate with the perfect fixtures.

Properties

- Material: pre-galvanised steel S-250-GD+Z275 (material no.: 1.0242) acc. to DIN EN 10346

Installation FLS

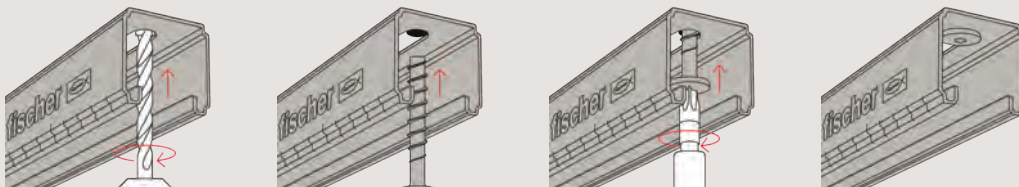

Technical data

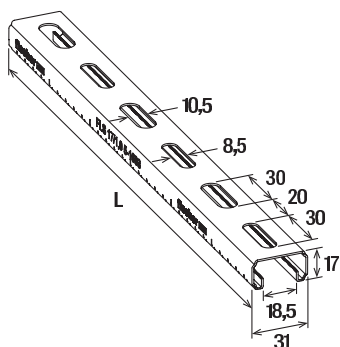

FLS 17/1.0

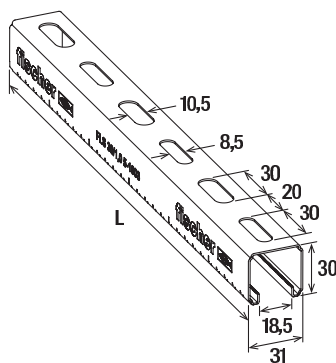

FLS 30/1.0

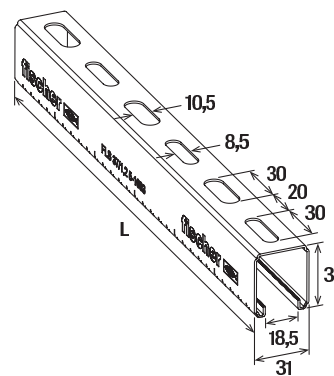

FLS 37/1.2

2b

Item	Item No.	Fire test report	Thickness S [mm]	Length L [mm]	Sales unit [pcs]
FLS 17/1.0 - 2 m	538753	—	1.0	2000	10
FLS 17/1.0 - 3 m	538754	—	1.0	3000	8
FLS 30/1.0 - 2 m	538755	—	1.0	2000	10
FLS 30/1.0 - 3 m	538756	—	1.0	3000	8
FLS 37/1.2 - 2 m	538757	X	1.2	2000	10
FLS 37/1.2 - 3 m	538758	X	1.2	3000	8
FLS 37/1.2 - 6 m	538759	X	1.2	6000	1

Loads

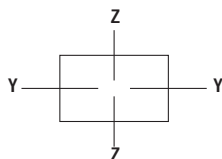

Item	Item No.	Weight [kg/m]	Profile cross section [cm ²]	Moment of inertia I _y [cm ⁴]	Moment of inertia I _z [cm ⁴]	Section modulus W _y [cm ³]	Section modulus W _z [cm ³]	Max. recommended static load for 1m length F _{rec} [kN]
FLS 17/1.0 - 2 m	538753	0.58	0.72	0.25	0.91	0.26	0.59	0.13
FLS 17/1.0 - 3 m	538754	0.58	0.72	0.25	0.91	0.26	0.59	0.13
FLS 30/1.0 - 2 m	538755	0.78	0.98	1.02	1.46	0.64	0.94	0.48
FLS 30/1.0 - 3 m	538756	0.78	0.98	1.02	1.46	0.64	0.94	0.48
FLS 37/1.2 - 2 m	538757	1.06	1.33	2.03	2.01	1.04	1.29	0.78
FLS 37/1.2 - 3 m	538758	1.06	1.33	2.03	2.01	1.04	1.29	0.78
FLS 37/1.2 - 6 m	538759	1.06	1.33	2.03	2.01	1.04	1.29	0.78

Load case 1

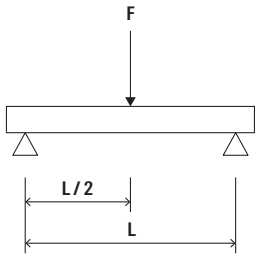

Load case 2

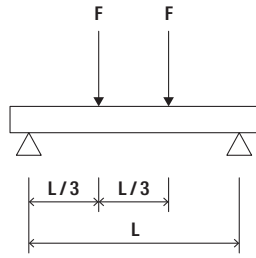

Load case 3

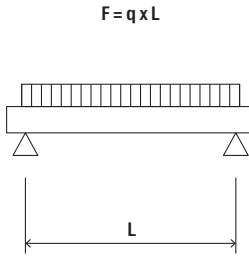

2b

FLS 17/1,0

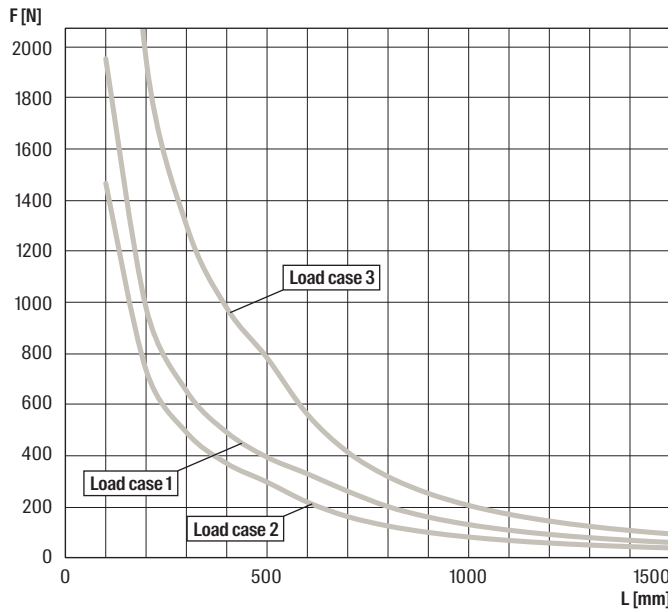

FLS 30/1,0

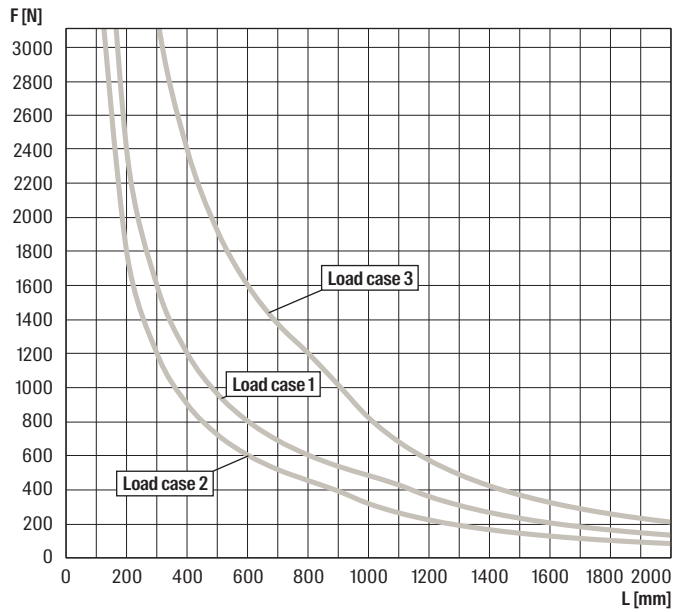

For the load curves, the permissible steel strain $\delta_{adm.} = 188$ N/mm (increased steel strain due to bending) and the maximum deflection under load $L/200$ are not exceeded. Fixings and screw fastenings must be calculated accordingly. The higher yield strength is a result of the calculation according to DIN EN 1993-1-3:2010-12, para. 3.2.2.

FLS 37/1,2

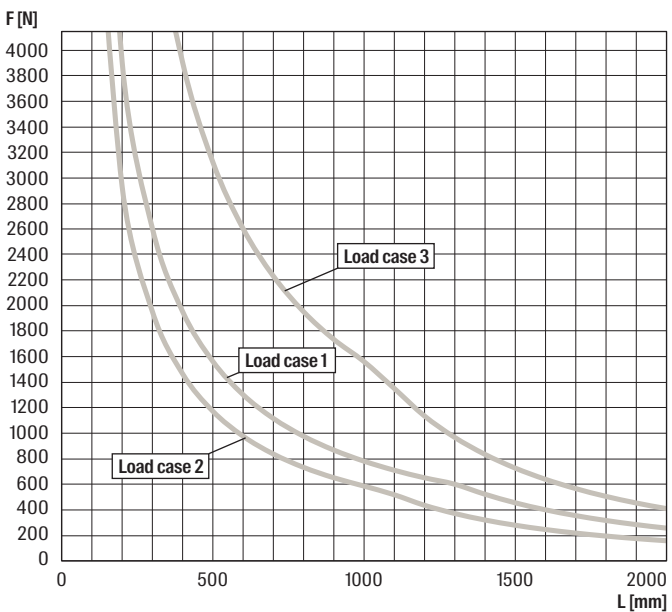

For the load curves, the permissible steel strain $\delta_{adm.} = 188$ N/mm (increased steel strain due to bending) and the maximum deflection under load $L/200$ are not exceeded. Fixings and screw fastenings must be calculated accordingly. The higher yield strength is a result of the calculation according to DIN EN 1993-1-3:2010-12, para. 3.2.2.

FLS Cutting Tool

The Cutting Tool for FLS channels



Air duct fixing with channel



Pipe fixing on frame construction

2b

Applications

- Efficient cutting of the FLS channels to the required length for processing in the installation.

Advantages/Benefits

- The FLS cutting tool for the three FLS channel sizes guarantees the most economical type of channel cutting, including length measurement by the integrated 1m-measuring unit.
- Simple burr-free cutting instead of sawing the channel profile to avoid the complex and time consuming reworking of the edges.
- The cutting process avoids falling metal chips as during the sawing process for a dirt free workplace.
- The manual cutting tool, which is always ready for use, allows an almost noiseless use.
- Due to the profile-shaped openings in the cutting tool, incorrect use is permanently avoided.

Properties

- Material: tempered tooling steel

Installation FLS

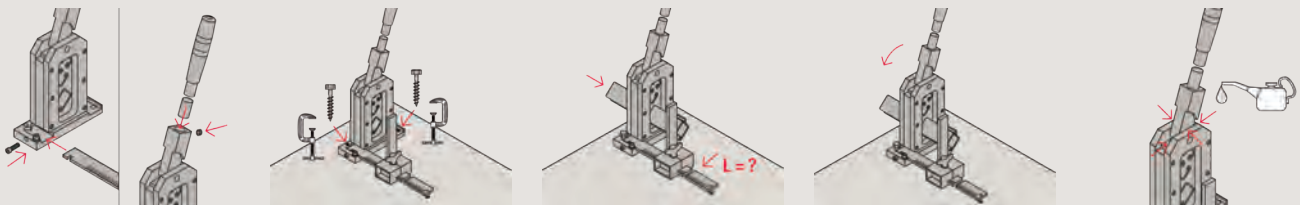

Technical data

2b

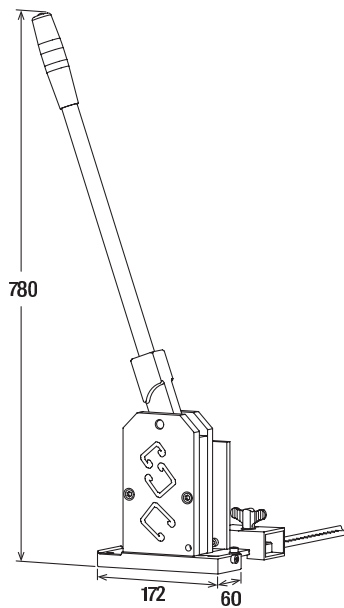

FLS

Item	Item No.	Performance data	Sales unit [pcs]
FLS cutting tool manual	543965	Incl. Operating lever and 1m measuring unit for length adjustment	1

Cantilever arm ALK

Cantilever arm made from FLS channel profile



Light pipe fixing



Cable tray on cantilever arm

2b

Applications

- The ALK cantilever arm allows the economic installation of single pipes or pipelines along the wall.

Certificates



Fire resistance classification
R120



MLAR R30

Advantages/Benefits

- The fire inspection report in line with MLAR/EN1363-1 of the ALK 37 guarantees independently tested functional safety.
- The graduated range of lengths allows an ideal adaptation to the application.
- The console's stable base plate offers a secure hold for a load-bearing construction.
- The base plate's long slots, which are at 90° to one another, allow the console to be easily aligned.

Properties

- Material Base plate: steel E295 (material no.: 1.0050) acc. to DIN EN 10025-2
- Material Channel: steel S215 G (material no.: 10116 G) acc. to DIN 1623
- Zinc plating: electro zinc-plated, min. 13 µm

Technical data

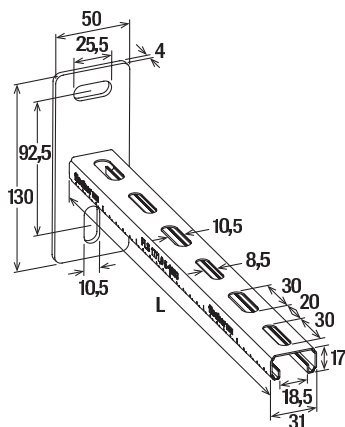

ALK 17

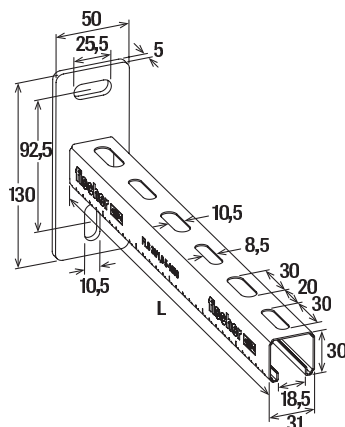

ALK 30

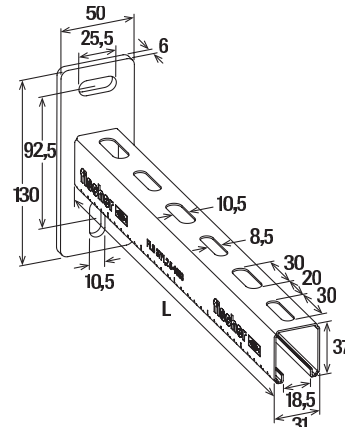

ALK 37

Item	Item No.	Fire test report	Profile	Length L [mm]	Sales unit [pcs]
ALK 17-200	538738	—	17/1,0	200	10
ALK 17-300	538739	—	17/1,0	300	10
ALK 30-200	538740	—	30/1,0	200	10
ALK 30-300	538741	—	30/1,0	300	10
ALK 30-450	538742	—	30/1,0	450	10
ALK 37-300	538743	X	37/1,2	300	10
ALK 37-450	538744	X	37/1,2	450	10
ALK 37-600	538745	X	37/1,2	600	5

Loads

Item	Item No.	Max. recommended static load load case 1	Max. recommended static load load case 2	Max. recommended static load load case 3
		F_{rec} [kN]	F_{rec} [kN]	F_{rec} [kN]
ALK 17-200	538738	0.49	0.24	0.49
ALK 17-300	538739	0.33	0.12	0.31
ALK 30-200	538740	1.18	0.59	1.18
ALK 30-300	538741	0.79	0.39	0.79
ALK 30-450	538742	0.53	0.22	0.53
ALK 37-300	538743	1.27	0.64	1.27
ALK 37-450	538744	0.86	0.41	0.86
ALK 37-600	538745	0.63	0.24	0.63

Load case 1

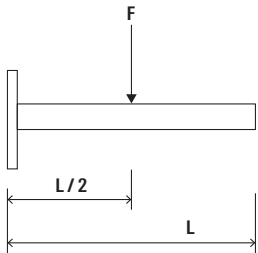

Load case 2

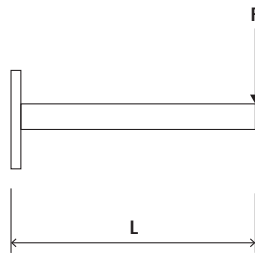

Load case 3

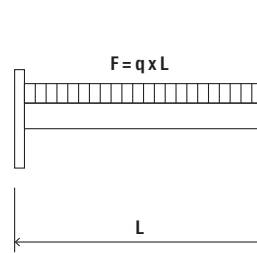

ALK 17/1,0

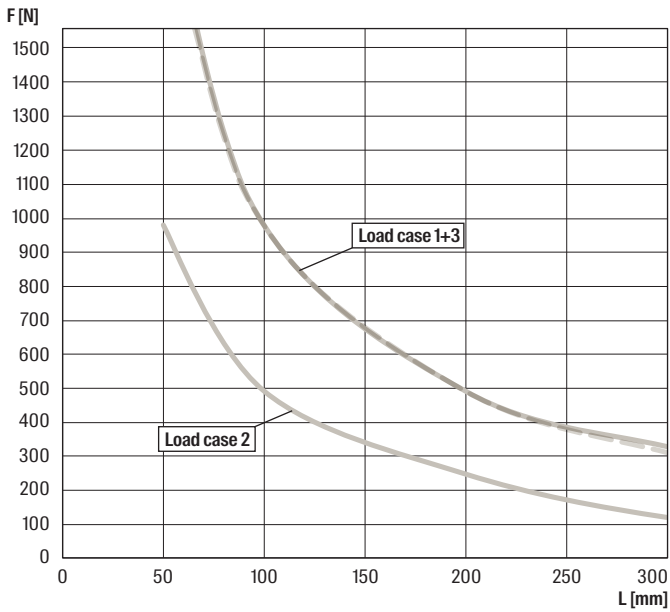

ALK 30/1,0

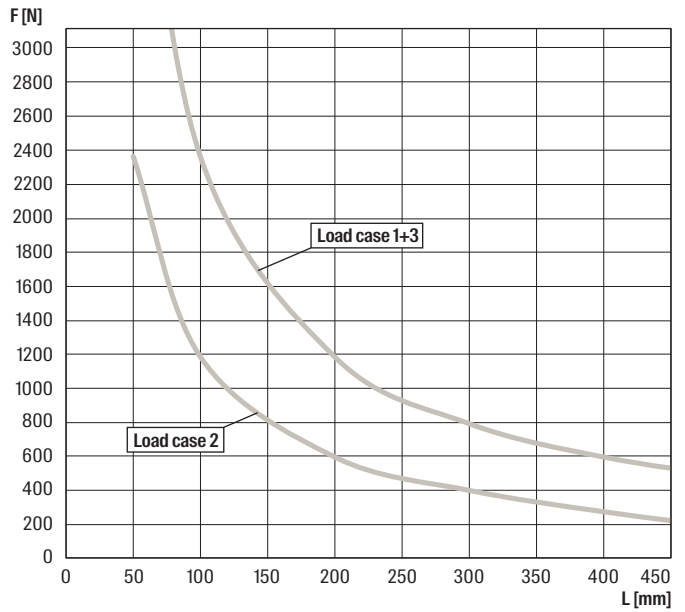

For the load curves, the permissible steel strain $\delta_{adm.} = 188 \text{ N/mm}^2$ (increased steel strain due to bending) and the maximum deflection under load $L/150$ are not exceeded. Fixings and screw fastenings must be calculated accordingly.

See also
Rail rubber insert
EMS



FLS 37/1,2

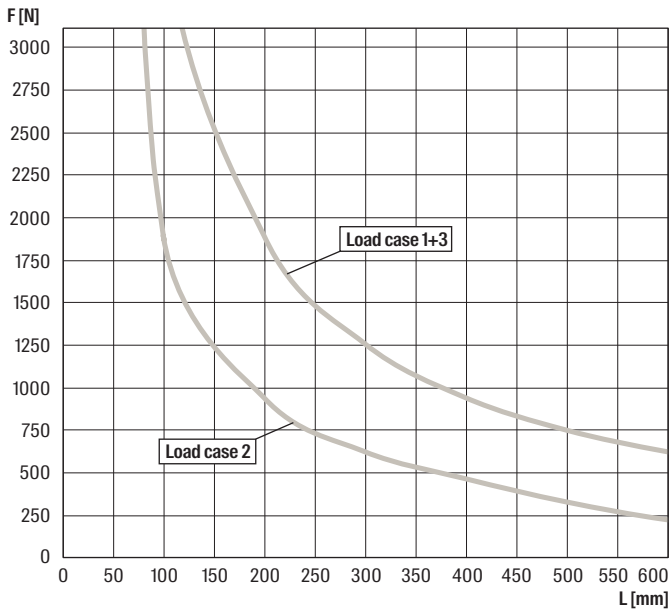

For the load curves, the permissible steel strain $\delta_{adm} = 188 \text{ N/mm}^2$ (increased steel strain due to bending) and the maximum deflection under load $L/150$ are not exceeded. Fixings and screw fastenings must be calculated accordingly.

Technical data



Item	Item No.	For profile	Material	Sales unit
				[pcs]
AK 17	538746	17/1.0	polypropylene	100
AK 30	538747	30/1.0	polypropylene	100
AK 37	538748	37/1.2	polypropylene	50

2b

Angle brace WS 31-45°

Angle brace for stable constructions

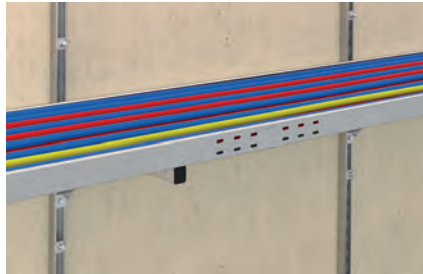

Cable tray on cantilever construction



Ventilating pipe fixing at the wall

Applications

- Angle brace to construct self-supporting channel constructions with FLS channels or ALK cantilever arms.

Advantages/Benefits

- The stable angle brace element WS 31-45° lends the supporting structure a great stability and safety.
- The size of the angle brace element guarantees a secure connection with ALK cantilever arms and FLS channels by its fitting accuracy.
- The standardised long slots in the angle brace enable an exact connection to ALK cantilever arms or FLS channels by using FSM Clix P and a screw.

Properties

- Material: steel S235 JR (material no.: 1.0037) acc. to DIN EN 10025
- Zinc plating: electro zinc-plated, min. 5 µm acc. DIN EN ISO 4042

Installation WS 31-45°

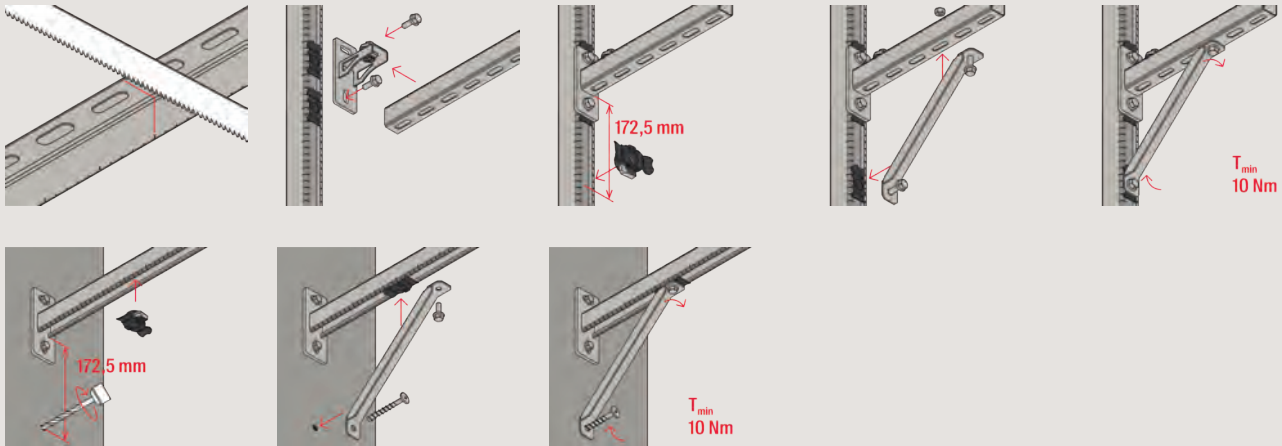

Technical data

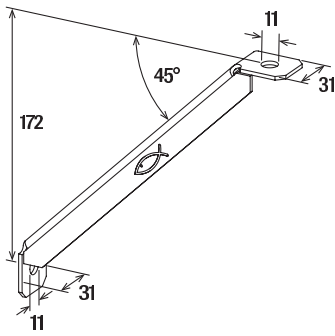

WS 31-45°

Item	Item No.	Eye-Ø D [mm]	Sales unit [pcs]
WS 31-45°	538749	11	10

Loads

Item	Item No.	Max. recommended static load load case 1a [kN]	Max. recommended static load load case 2a [kN]	Max. recommended static load load case 3a [kN]
ALK 17-200	538738	1.03	1.03	1.03
ALK 17-300	538739	1.52	0.45	1.52
ALK 30-200	538740	2.52	1.40	2.52
ALK 30-300	538741	1.78	0.89	1.78
ALK 30-450	538742	1.16	0.47	1.16
ALK 37-300	538743	1.78	0.89	1.78
ALK 37-450	538744	1.16	0.59	1.16
ALK 37-600	538745	0.89	0.45	0.89

Note: Loads are valid for fixing to wall with adequate carrying capacity. Fixing of the cantilever arm and the angle brace to the wall by anchor (e.g. FAZ II, FBS 8). Fixing of the angle brace to the cantilever profile by FSM Clix P 10, tightening torque 12 Nm. Fixing of the angle brace to the long slot of the cantilever profile by screw and nut M10, tightening torque 20 Nm.

Load case 1

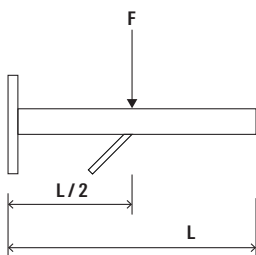

Load case 2

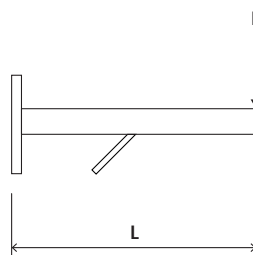

Load case 3

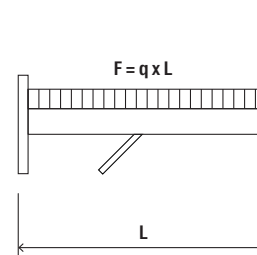

Channel connector SV 31

Construction element - Channel connector SV 31

2b

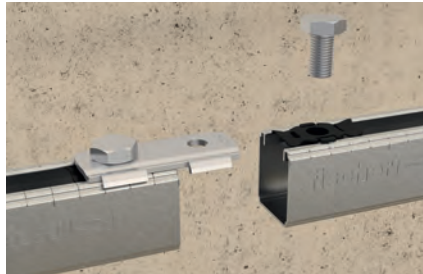

Channel extension with channel connector

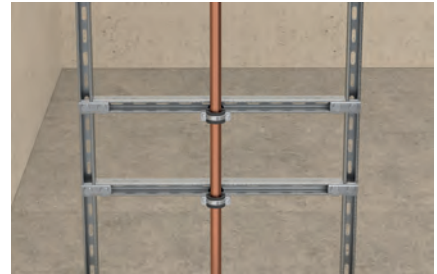

Vertical installation

Applications

- With the channel connector SV 31 FLS channels can be connected in different directions.

Advantages/Benefits

- The special retaining brackets at the SV construction elements enable a form-locking installation longitudinal and transverse to the channel direction to adapt the channel connection effectively
- The standardised long slots of the channel connector enable an exact connection to ALK cantilever arms or FLS channels by using FSM Clix P and a screw

Properties

- Material: steel S235 JR+CR (material no.: 1.0037) acc. to DIN EN 1652
- Zinc plating: electro zinc-plated, min. 5 µm acc. DIN EN ISO 4042

Installation SV 31

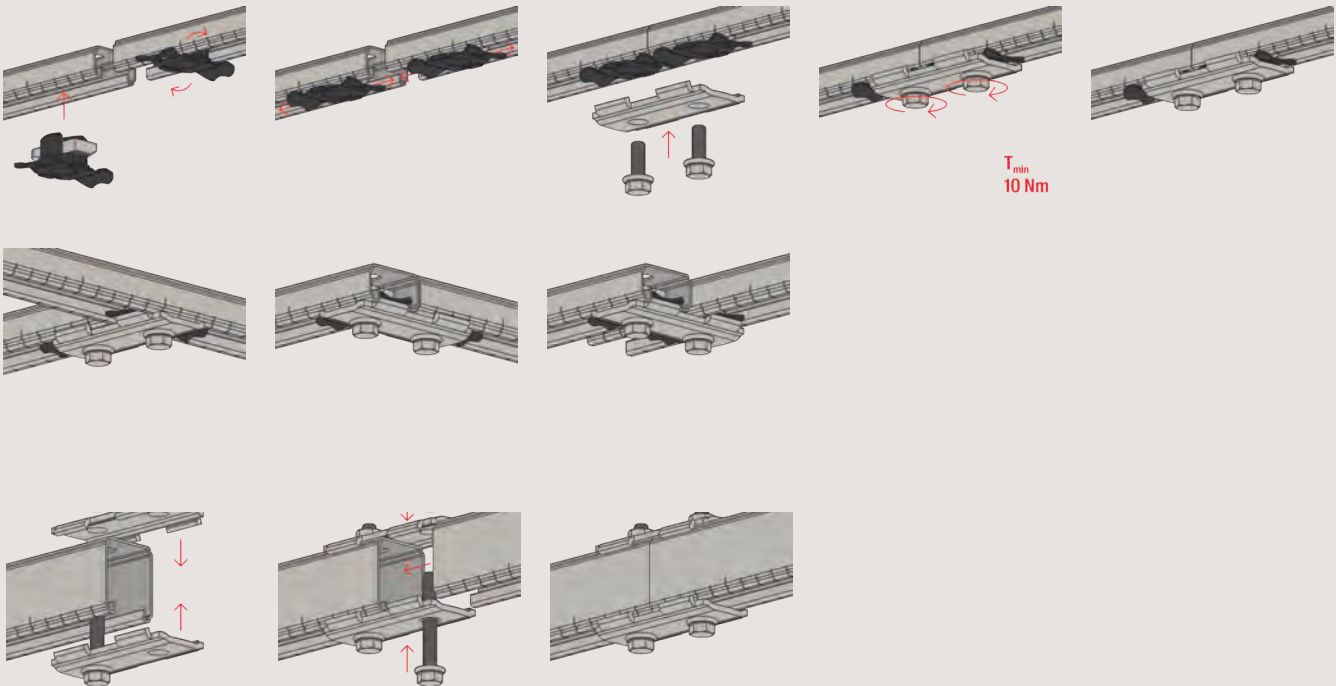

Technical data

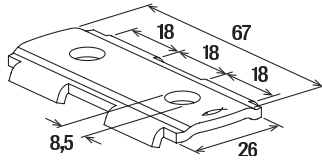

SV 31

Item	Item No.	Hole-Ø D [mm]	Sales unit [pcs]
SV 31	538641	8.5	25

2b

Loads

Item	Item No.	Max. recommended shear load V_{rec} [kN]	Tightening torque T_{inst} [Nm]
SV 31	538641	1.0	10

Sliding channel nut FSM Clix P

Channel nut for quick and easy connection of FLS channels

2b

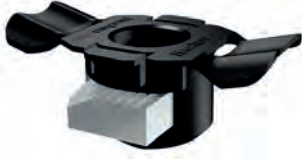

Floor penetration

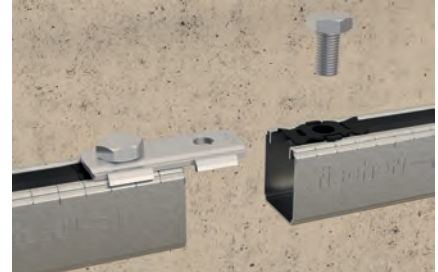

Channel extension with channel connector

Applications

FSM Clix P is suitable for interconnecting FLS channels by using connecting elements.

Certificates



Fire resistance classification
R120



MLAR R30

Advantages/Benefits

- The special and disappearing thrust block of the sliding nut Clix P plastic holder enables a connection of connecting elements and channels without plastic interlayer to establish a safe longitudinal metallic connection.
- The especially developed spring leg on the FSM Clix P guarantees the necessary contact pressure of the connector to the channel to help for a secure adjustment during installation.
- The teeth on the sliding nut enable an exact and secure positioning in the FLS channel and ease the installation of connector elements.
- The unique stop element on the FSM Clix P connector guarantees the accurate 90°-turn of the connectors in the channel to ensure a save and precise installation.

Properties

- Material channel nut: steel S420MC (material no.: 1.0980) acc. DIN EN 10149-2
- Material plastic cage: polypropylene PP, item number 11400, Color black
- Zinc plating: electro zinc-plated, min. 5 µm acc. DIN EN ISO 4042

Installation FSM Clix P



Technical data

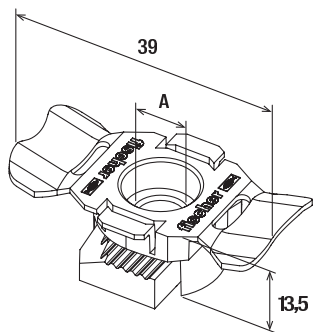

FSM Clix P

Item	Item No.	Thread A	Sales unit [pcs]
FSM Clix P 6	538643	M 6	50
FSM Clix P 8	538647	M 8	50
FSM Clix P 10	538649	M 10	50

Loads

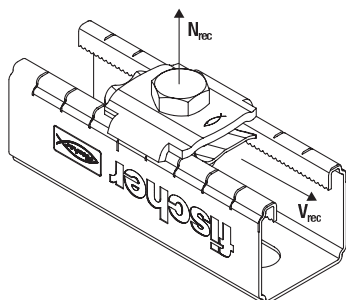

FSM Clix P

Item	Item No.	Max. recommended tension load for FLS 17/1.0 and FLS 30/1.0	Max. recommended tension load for FLS 37/1.2	Max. recommended shear load	Tightening torque
		N_{rec} [kN]	N_{rec} [kN]	V_{rec} [kN]	T_{inst} [Nm]
FSM Clix P 6	538643	1.5	2.0	1.0	10
FSM Clix P 8	538647	1.5	2.0	1.0	10
FSM Clix P 10	538649	1.5	2.0	1.0	10

Sliding channel nut FSM Clix M

Channel nut for quick and easy fixing in FLS channels

2b

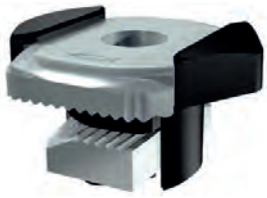

Pipe fixing at mounting channel



Pipe fixing on frame construction

Applications

FSM Clix M is suitable for connecting pipe clamps with a threaded rod to FLS channels.

Certificates



Fire resistance classification
R120



MLAR R30

Advantages/Benefits

- The unique spring leg at the FSM Clix M guarantees the necessary contact pressure of the connector to the channel to help for a secure adjustment during installation.
- The teeth on the sliding nut enable an exact and secure positioning in the FLS channel and ease the installation of connector elements.
- The clix-connector element with 90°-turn for connecting enables an easy post-installation in set channels to save time and money.
- The especially developed stop element on the FSM Clix M connector guarantees the accurate 90°-turn of the connectors in the channel to ensure a safe and precise installation.

Properties

- Material channel nut: steel S420MC (material no.: 1.0980) acc. DIN EN 10149-2
- Material cover plate: steel S235JR+CR (material no.: 1.0037) acc. DIN 1652
- Material plastic cage: polypropylene PP, item number 11400, Color black
- Zinc plating: electro zinc-plated, min. 5 µm acc. DIN EN ISO 4042

Installation FSM Clix M

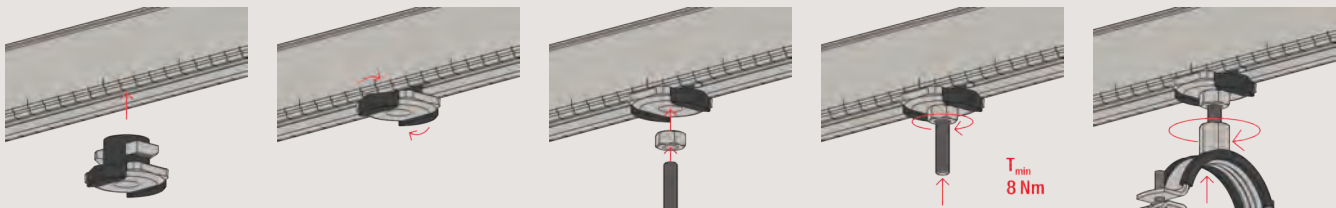

Technical data

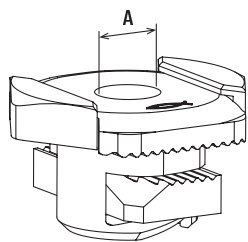

FSM Clix M

2b

Item	Item No.	Thread A	Width across nut SW [mm]	Sales unit [pcs]
FSM Clix M 6	538650	M 6	10	50
FSM Clix M 8	538651	M 8	13	50
FSM Clix M 10	538652	M 10	17	50

Loads

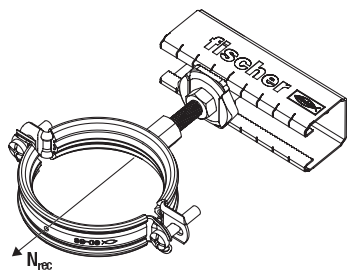

FSM Clix M

Item	Item No.	Max. recommended tension load for FLS 17/1.0 and FLS 30/1.0 N_{rec} [kN]	Max. recommended tension load for FLS 37/1.2 N_{rec} [kN]	Tightening torque T_{inst} [Nm]
FSM Clix M 6	538650	1.5	2.0	8
FSM Clix M 8	538651	1.5	2.0	8
FSM Clix M 10	538652	1.5	2.0	8

T-head bolt FHS Clix

Hammer-head bolt for quick and easy fixing in FLS channels

2b



Light pipe fixing



Pipe fixing at mounting channel

Applications

- FHS Clix is suitable for connecting pipe clamps with the channel.

Certificates



Fire resistance classification
R120



MLAR R30

Advantages/Benefits

- The special spring leg at the FHS Clix guarantees the necessary contact pressure of the connector to the channel to help for a secure adjustment during installation.
- The teeth on the sliding nut enable an exact and secure positioning in the FLS channel and ease the installation of connector elements.
- The clix-connector element with 90°-turn for connecting enables an easy post-installation in set channels to save time and money.
- The especially developed stop element on the FHS Clix connector guarantees the accurate 90°-turn of the connectors in the channel to ensure a safe and precise installation.

Properties

- Material channel nut: steel S420MC (material no.: 1.0980) acc. DIN EN 10149-2
- Material cover plate: steel S235JR+CR (material no.: 1.0037) acc. DIN 1652
- Material threaded rod: steel acc. DIN 976-2, min. 4.6 (DIN EN ISO 898-1)
- Material hexagonal nut: steel acc. DIN 934-4 min. 4.8 (DIN EN ISO 898-2 table 4 stability)
- Material plastic cage: polypropylene PP, item number 11400, Color black
- Zinc plating: electro zinc-plated, min. 5 μm acc. DIN EN ISO 4042

Installation FHS Clix

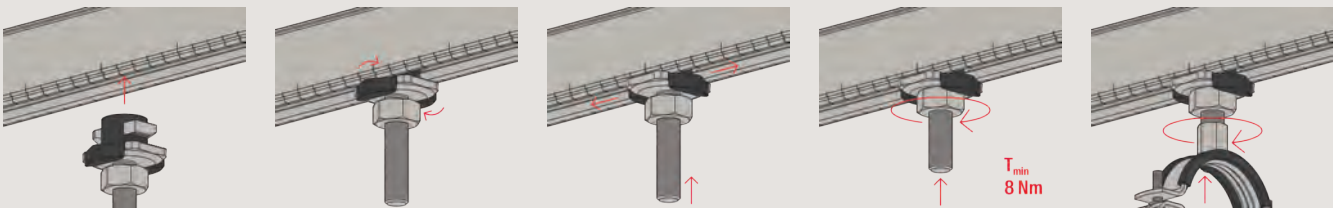

Technical data

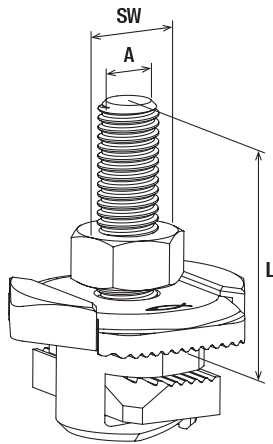

FHS Clix

Item	Item No.	Thread A	Length [mm]	Width across nut SW [mm]	Sales unit [pcs]
FHS Clix 8 x 30	538653	M 8	30	13	100
FHS Clix 8 x 40	538654	M 8	40	13	100
FHS Clix 8 x 60	538655	M 8	60	13	100
FHS Clix 8 x 80	538656	M 8	80	13	50
FHS Clix 8 x 100	538657	M 8	100	13	50
FHS Clix 8 x 140	545834	M 8	140	13	50
FHS Clix 8 x 190	545835	M 8	190	13	50
FHS Clix 10 x 30	538658	M 10	30	17	100
FHS Clix 10 x 40	538659	M 10	40	17	100
FHS Clix 10 x 60	538660	M 10	60	17	50
FHS Clix 10 x 80	545836	M 10	80	17	50
FHS Clix 10 x 100	538661	M 10	100	17	50

Loads

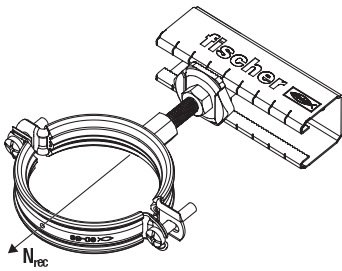

FHS Clix

Item	Item No.	Max. recommended tension load for FLS 17/1.0 and FLS 30/1.0	Max. recommended tension load for FLS 37/1.2	Tightening torque
		N_{rec} [kN]	N_{rec} [kN]	T_{inst} [Nm]
FHS Clix 8 x 30	538653	1.5	2.0	8
FHS Clix 8 x 40	538654	1.5	2.0	8
FHS Clix 8 x 60	538655	1.5	2.0	8
FHS Clix 8 x 80	538656	1.5	2.0	8
FHS Clix 8 x 100	538657	1.5	2.0	8
FHS Clix 10 x 30	538658	1.5	2.0	8
FHS Clix 10 x 40	538659	1.5	2.0	8
FHS Clix 10 x 60	538660	1.5	2.0	8
FHS Clix 10 x 100	538661	1.5	2.0	8

Saddle flange SF Clix 31

The pre-assembled saddle flange SF Clix 31

2b



Channel installation at the wall

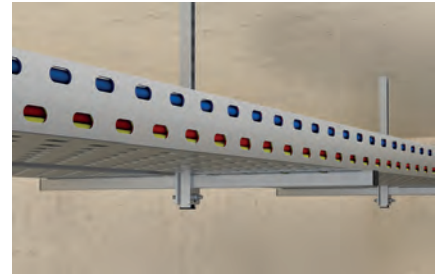

Suspended cable tray fixing

Applications

Element for the stable construction of connections between channels and building structures.

Advantages/Benefits

- Pre-assembled accessories like SF Clix bring the number of articles for a connection down and guarantee a time-saving installation.
- The pre-assembled connector of the SF Clix secures the installation position due to the unique thrust block and guarantees a safe and fast installation.
- The special spring leg at pre-assembled connector guarantees the necessary contact pressure of the connector to the channel to help for a secure adjustment during installation.
- The perfect-fit saddle of the SF allows an simple installation by inserting the channel.
- The saddle flange's stable design offers a secure hold for a load-bearing construction.

Properties

- Material saddle: steel E295 (material no.: 1.0050) acc. DIN EN 10025-2
- Material channel nut: steel S420MC (material no.: 1.0980) acc. DIN EN 10149-2
- Material cover plate: steel S235JR+CR (material no.: 1.0037) acc. DIN 1652
- Material hexagonal screw: steel min. 4.6 (DIN EN ISO 898-1)
- Material plastic cage: polypropylene PP, item number 11400, Color black
- Zinc plating: electro zinc-plated, min. 5 µm, hexagonal screw min. 3 µm acc. DIN EN ISO 4042

Installation SF Clix 31

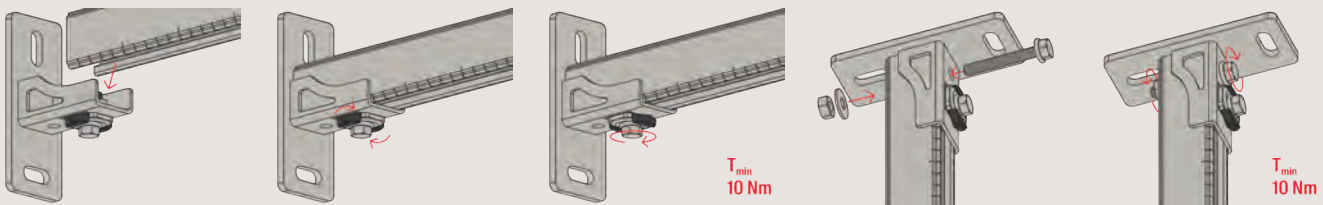

Technical data

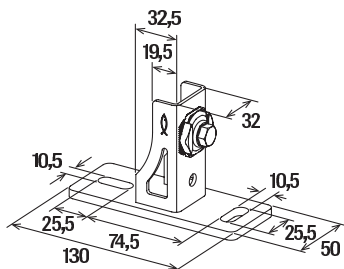

SF Clix 31

Item	Item No.	Thread A	Width across nut SW [mm]	Sales unit [pcs]
SF Clix 31	538665	M 8	13	10

2b

Loads

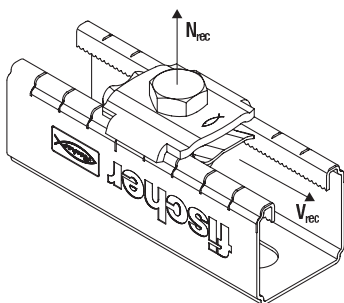

SF Clix 31

Item	Item No.	Max. recommended tension load for FLS 17/1.0 and FLS 30/1.0 N_{rec} [kN]	Max. recommended tension load for FLS 37/1.2 N_{rec} [kN]	Max. recommended shear load V_{rec} [kN]	Tightening torque T_{inst} [Nm]
SF Clix 31	538665	1.5	2.0	1.0	10

Angle bracket MW Clix 90°

The pre-assembled angle bracket MW Clix 90°

2b

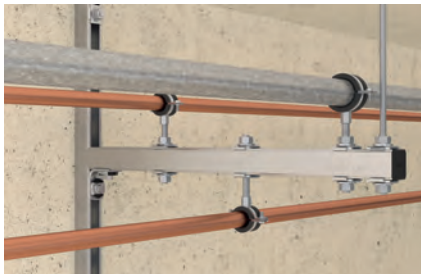

Cantilever construction with channel



Pipe fixing on frame construction

Applications

- Element for the stable construction of angle connections with FLS channels.

Advantages/Benefits

- Pre-assembled accessories like SF Clix bring the number of articles for a connection down and guarantee a time-saving installation.
- The pre-assembled connector of the MW Clix secures the installation position due to the unique thrust block and guarantees a safe and fast installation.
- The especially developed spring leg at the pre-assembled connector guarantees the necessary contact pressure of the connector to the channel to help for a secure adjustment during installation.
- The form-locking and accurately fitting angle bracket of the MW clix allows a simple installation of the FLS channel and saves valuable installation time.

Properties

- Material angle bracket: steel S235JR+CR (material no.: 1.0037) acc. DIN 1652
- Material channel nut: steel S420MC (material no.: 1.0980) acc. DIN EN 10149-2
- Material cover plate: steel S235JR+CR (material no.: 1.0037) acc. DIN 1652
- Material hexagonal screw: steel min. 4.6 (DIN EN ISO 898-1)
- Material plastic cage: polypropylene PP, item number 11400, Color black
- Zinc plating: electro zinc-plated, min. 5 µm, hexagonal screw min. 3 µm acc. DIN EN ISO 4042

Installation FMPC

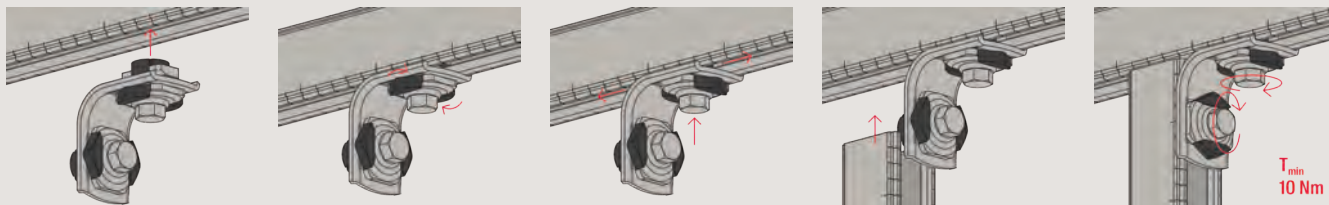

Technical data

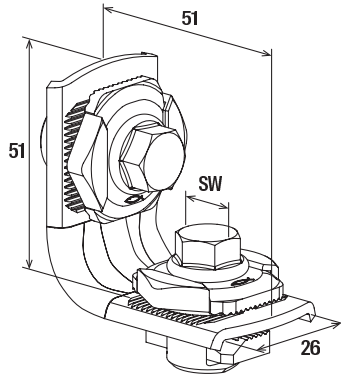

2b

Item	Item No.	Thread A	Width across nut SW [mm]	Sales unit [pcs]
MW Clix 90°	538666	M 8	13	10

Loads

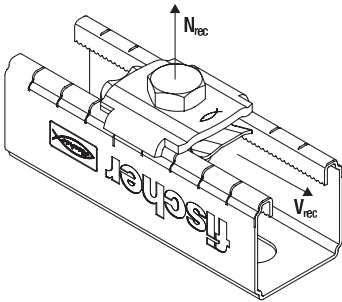

Item	Item No.	Max. recommended tension load for FLS 17/1.0 and FLS 30/1.0 N_{rec} [kN]	Max. recommended tension load for FLS 37/1.2 N_{rec} [kN]	Max. recommended shear load V_{rec} [kN]	Tightening torque T_{inst} [Nm]
MW Clix 90°	538666	1.5	2.0	1.0	10

Angle bracket MW and MWU

Construction element – Angle bracket MW 90° and MWU 90°

2b



Floor penetration



Pipe fixing in a corridor

Applications

- Connecting elements for the arrangement of simple channel constructions with the sliding channel nut FSM Clix P.

Advantages/Benefits

- The individual developed retaining brackets at the MW 90° angle bracket enable a form-locking installation longitudinal and transverse to the channel direction to adapt the channel connection effectively.
- The long slot on flat wing of the MWU 90° angle bracket enables a direct connection to the substrate for space-saving fixation.
- The standardised holes in the angle brackets enable an exact connection to the FLS channels by using FSM Clix P and a screw.

Properties

- Material: steel S235 JR+CR (material no.: 1.0037) acc. to DIN EN 1652
- Zinc plating: electro zinc-plated, min. 5 µm acc. DIN EN ISO 4042

Installation MW

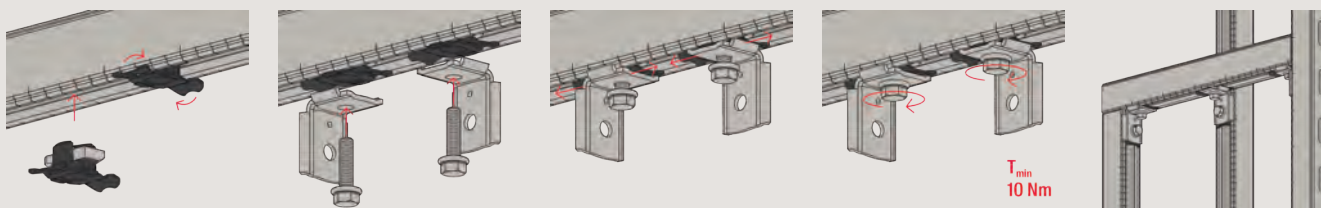

Installation MWU

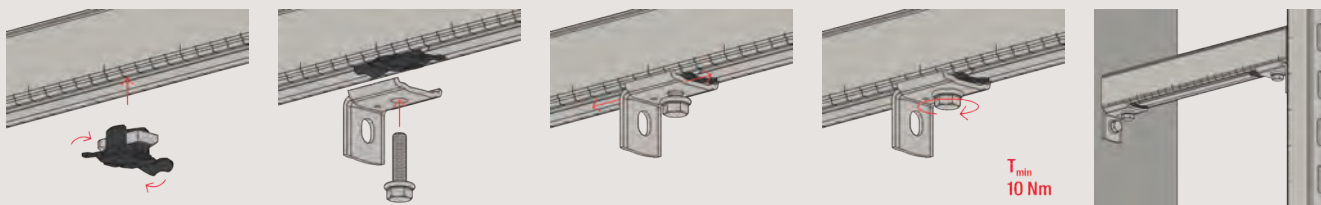

Technical data

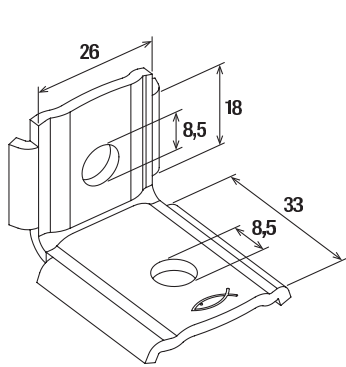

MW 90°

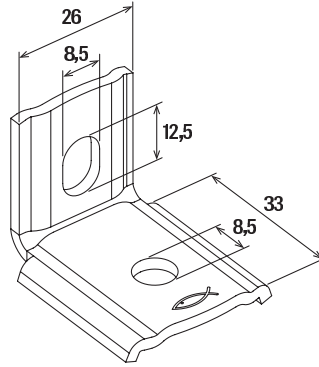

MWU 90°

2b

Item	Item No.	Hole-Ø D [mm]	Sales unit [pcs]
MW 90°	538668	8.5	50
MWU 90°	538667	8.5	25

Loads

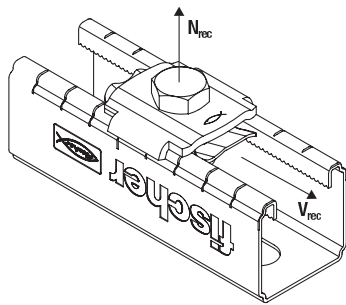

MW 90° and MWU 90°

Item	Item No.	Max. recommended tension load for FLS 17/1.0 and FLS 30/1.0	Max. recommended tension load for FLS 37/1.2	Max. recommended shear load	Tightening torque
		N_{rec} [kN]	N_{rec} [kN]		
MW 90°	538668	1.5	2.0	1.0	10
MWU 90°	538667	1.5	2.0	1.0	10

Channel washer HK 31

Connector - Channel washer HK 31

2b

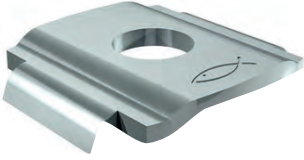

Pipe fixing at mounting channel



Horizontal pipe fixing

Applications

The Channel washer HK 31 is used for stable connections and to strengthen the profile for a fixing to the substrate.

Certificates



Fire resistance classification
R120



MLAR R30

Advantages/Benefits

- The special retaining brackets at the SV connecting elements enable a form-locking installation longitudinal and transverse to the channel direction to adapt the channel connection effectively.
- The standardised slots of the Channel washer enable an exact push-through connection of FLS mounting channels easy and fast.

Properties

- Material: steel S235 JR+CR (material no.: 1.0037) acc. to DIN EN 1652
- Zinc plating: electro zinc-plated, min. 5 µm acc. DIN EN ISO 4042

Technical data

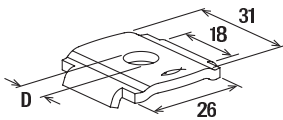

HK 31

Item	Item No.	Hole-Ø D [mm]	Sales unit [pcs]
HK 31 8,5	538663	8.5	50
HK 31 10,5	538664	10.5	50

Beam clamp TKR 31

Clamping bracket for the fixing of channels to steel girders



Channel fixing to steel beam

2b

Applications

- Fixing of FLS channels to steel girders, required are two beam clamps per fixing.

Advantages/Benefits

- The design of the beam clamp allows for fixing without drilling or welding.
- The various lengths of the beam clamp sides allows for fixing on all standard steel beams.
- The shape of the beam clamp guarantees the simple adjustment of the channel connection.

Properties

- Material U-bolt pipe hanger: steel S235 JR (material no.: 1.0037) acc. DIN EN 10025-2
- Material plate: steel E295 (material no.: 1.0050) acc. DIN EN 10025-2
- Material hexagon nut: steel resistance class 8
- Zinc plating: electro zinc-plated, min. 5 µm acc. DIN EN ISO 4042

Technical data

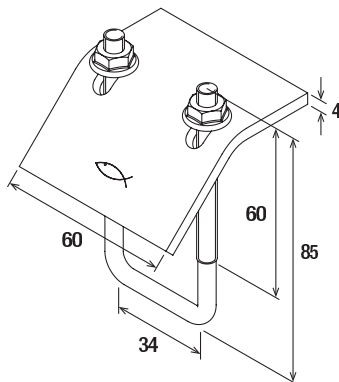

TKR 31

Item	Item No.	Thread A	Width across nut SW [mm]	Sales unit [pcs]
TKR 31	538751	M 6	10	25

Loads

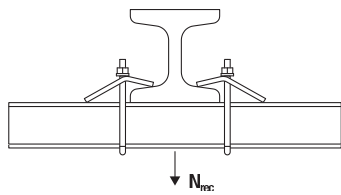

TKR





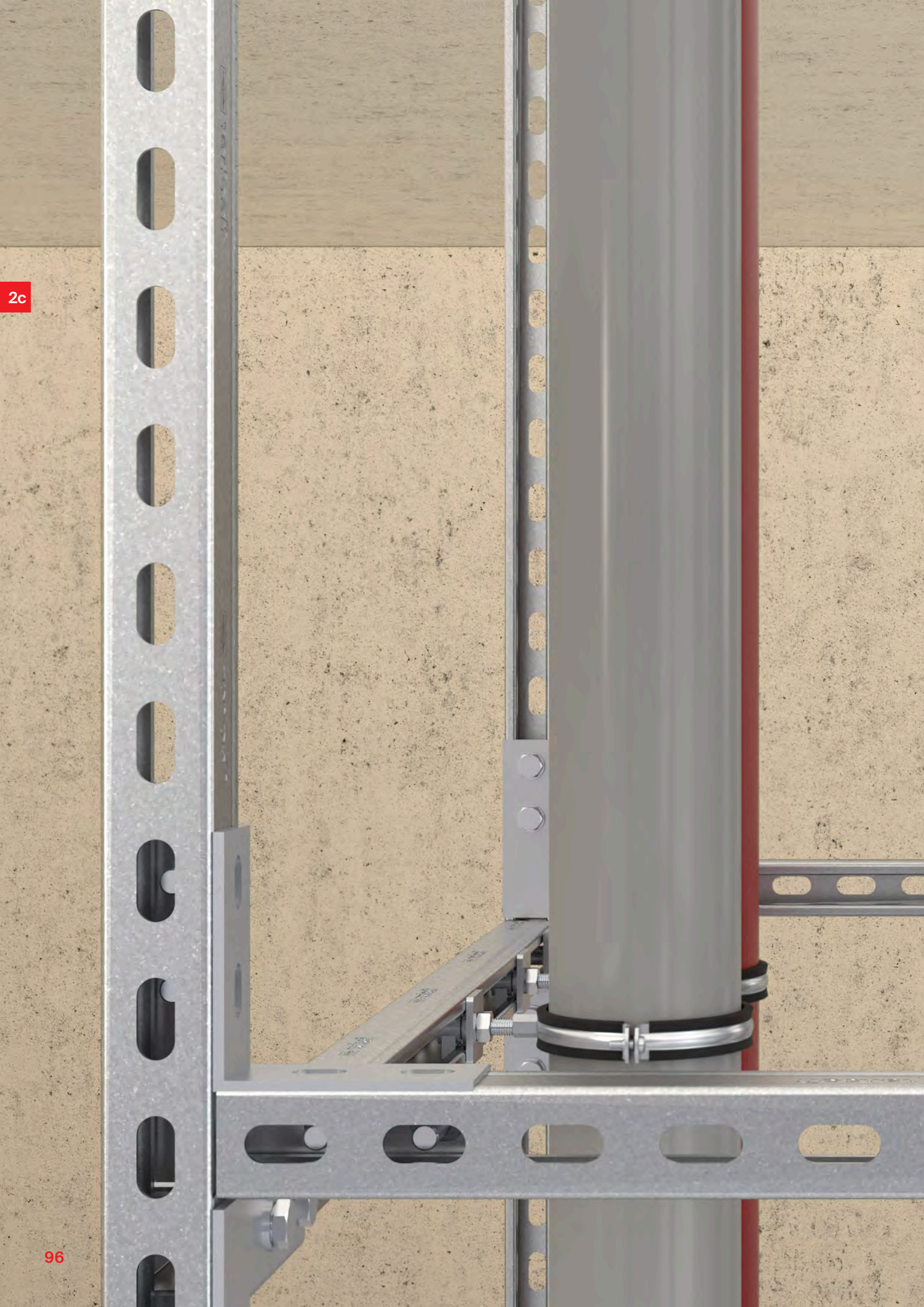

























Item	Item No.	Max. recom. static load (centr. tension) $N_{recom.}$ [kN]	Tightening torque T_{inst} [Nm]
TKR 31	538751	2.80	5

2c



2c

Channel system universal FUS

Channel FUS	98		T-head bolt FHS Clix S	129	
Channel connector FDCC	104		T-head bolt FCSN	131	
Cantilever arm FCA	106		Channel nut FCN	133	
Large cantilever arm FCAM	111		Channel washer HK 41	134	
Cover cap FEC	112		Saddle flange SF	135	
Push-through connector PFCN	113		Mounting bracket UWS	136	
Saddle flange PSF	115		Angle bracket WK	137	
Universal bracket PUWS	116		Bracket FFF	139	
Angle bracket PWK	117		Bracket FAF	140	
Variable bracket PVB	118		Flanges FZF	141	
Bracing elements PSAE	119		Flanges FUF	142	
Channel connector FUF OC and PFUF OC	121		Variable bracket VB	143	
Bracket PFFF	122		Universal mounting UHRS	144	
Bracket PFAF	123		Universal hinge FUH	145	
Bracket PFUF	125		Threaded rod bracket FSB 45°	147	
Bracket PFUF D	126		Beam clamp TKR	148	
Connector FCN Clix P and FCN Clix M	127				

Channel FUS

The universal and complete mounting channel system for a wide range of applications

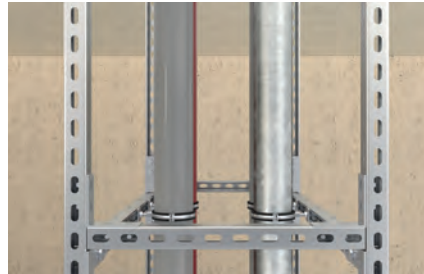

3D-frame constructions



Solid frame construction

Applications

- Secure horizontal and vertical installations
- Fast and efficient fixing of pipelines and supporting structures

Certificates



Fire resistance classification
R120



MLAR R30

Advantages/benefits

- The fire inspection report in line with MLAR/EN13501 guarantees independently tested functional safety.
- The basic channel geometry allows the usage of the complete extensive range of accessories.
- The stamped teeth in the channel give the sliding nuts a secure hold for high shear loads, e.g. for vertical installation.
- Different channel wall thicknesses allow economical choices for installation.
- The scale on the mounting channels simplifies the cutting and positioning of the fixtures during the installation.

Properties

- Material: pre-galvanised steel S-250-GD+Z275 (material no.: 1.0242) acc. to DIN EN 10346

See also

Connector FCN
Clix P/M

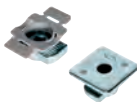

Rail rubber insert
EMS



Technical data

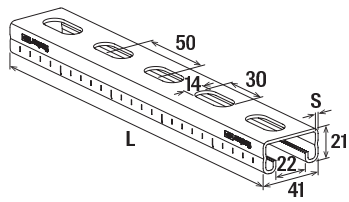

FUS 21

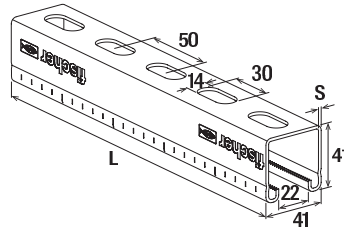

FUS 41

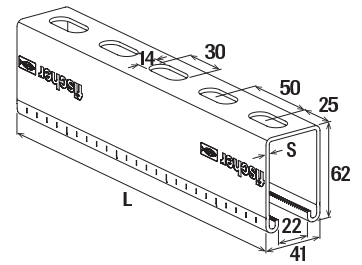

FUS 62

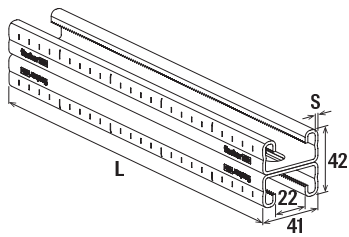

FUS 21D

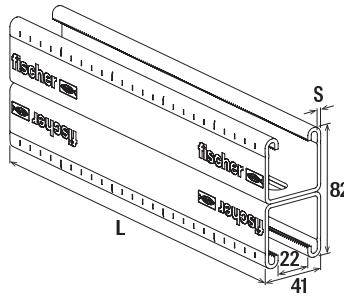

FUS 41D

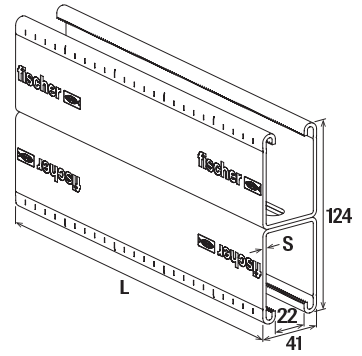

FUS 62D

2c

Item	Item No.	Fire test report	Length L [mm]	Thickness S [mm]	Sales unit [pcs]
FUS 21/1,5 - 2 m	545117	—	2000	1.5	1
FUS 21/1,5 - 3 m	545118	—	3000	1.5	1
FUS 21/1,5 - 6 m	545119 ¹⁾	—	6000	1.5	1
FUS 21/2,0 - 2 m	040391	—	2000	2	1
FUS 21/2,0 - 3 m	097660	—	3000	2	1
FUS 21/2,0 - 6 m	097661	—	6000	2	1
FUS 21/2,5 - 2 m	092867	—	2000	2.5	1
FUS 21/2,5 - 3 m	077349	—	3000	2.5	1
FUS 21/2,5 - 6 m	077541	—	6000	2.5	1
FUS 41/1,5 - 2 m	545120	—	2000	1.5	1
FUS 41/1,5 - 3 m	545126	—	3000	1.5	1
FUS 41/1,5 - 6 m	545127	—	6000	1.5	1
FUS 41/2,0 - 2 m	040390	—	2000	2	1
FUS 41/2,0 - 3 m	097658	—	3000	2	1
FUS 41/2,0 - 6 m	097659	—	6000	2	1
FUS 41/2,5 - 2 m	092295	X	2000	2.5	1
FUS 41/2,5 - 3 m	077347	X	3000	2.5	1
FUS 41/2,5 - 6 m	077537	X	6000	2.5	1
FUS 62/2,5 - 6 m	504457	X	6000	2.5	1
FUS 21D/2,0 - 3 m	504458	—	3000	2	1
FUS 21D/2,0 - 6 m	535531	—	6000	2	1
FUS 41D/2,5 - 6 m	504459	—	6000	2.5	1
FUS 62D/2,5 - 6 m	504460	—	6000	2.5	1

1) Delivery time on request.

Loads

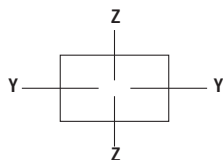

2c

Item	Item No.	Profil weight [kg/m]	Profile cross section [cm ²]	Moment of inertia <i>I_y</i> [cm ⁴]	Moment of inertia <i>I_z</i> [cm ⁴]	Section modulus <i>W_y</i> [cm ³]	Section modulus <i>W_z</i> [cm ³]	Max. recommended static load for 1m length <i>F_{rec}</i> [kN]	Max. recommended static load for 2m length <i>F_{rec}</i> [kN]	Max. recommended static load for 3m length <i>F_{rec}</i> [kN]
FUS 21/1,5 - 2 m	545117	1.20	1.35	0.8	3.69	0.75	1.80	0.41	0.10	—
FUS 21/1,5 - 3 m	545118	1.20	1.35	0.8	3.69	0.75	1.80	0.41	0.10	—
FUS 21/1,5 - 6 m	545119 ¹⁾	1.20	1.35	0.8	3.69	0.75	1.80	0.41	0.10	—
FUS 21/2,0 - 2 m	040391	1.44	1.72	0.97	4.66	0.89	2.27	0.49	0.12	—
FUS 21/2,0 - 3 m	097660	1.44	1.72	0.97	4.66	0.89	2.27	0.49	0.12	0.05
FUS 21/2,0 - 6 m	097661	1.44	1.72	0.97	4.66	0.89	2.27	0.49	0.12	0.05
FUS 21/2,5 - 2 m	092867	1.67	1.99	1.03	5.28	0.93	2.58	0.52	0.13	—
FUS 21/2,5 - 3 m	077349	1.67	1.99	1.03	5.28	0.93	2.58	0.52	0.13	0.06
FUS 21/2,5 - 6 m	077541	1.67	1.99	1.03	5.28	0.93	2.58	0.52	0.13	0.06
FUS 41/1,5 - 2 m	545120	1.80	1.95	4.26	6.03	2.07	2.94	1.56	0.54	—
FUS 41/1,5 - 3 m	545126	1.80	1.95	4.26	6.03	2.07	2.94	1.56	0.54	0.24
FUS 41/1,5 - 6 m	545127	1.80	1.95	4.26	6.03	2.07	2.94	1.56	0.54	0.24
FUS 41/2,0 - 2 m	040390	2.06	2.52	5.33	7.69	2.58	3.75	1.94	0.67	—
FUS 41/2,0 - 3 m	097658	2.06	2.52	5.33	7.69	2.58	3.75	1.94	0.67	0.30
FUS 41/2,0 - 6 m	097659	2.06	2.52	5.33	7.69	2.58	3.75	1.94	0.67	0.30
FUS 41/2,5 - 2 m	092295	2.45	3.00	6.00	8.99	2.85	4.38	2.14	0.76	—
FUS 41/2,5 - 3 m	077347	2.45	3.00	6.00	8.99	2.85	4.38	2.14	0.76	0.34
FUS 41/2,5 - 6 m	077537	2.45	3.00	6.00	8.99	2.85	4.38	2.14	0.76	0.34
FUS 62/2,5 - 6 m	504457	3.27	4.05	17.70	12.90	5.62	6.29	4.22	2.10	0.99
FUS 21D/2,0 - 3 m	504458	2.87	3.44	5.49	9.31	2.61	4.54	1.96	0.69	0.31
FUS 21D/2,0 - 6 m	535531	2.87	3.44	5.49	9.31	2.61	4.54	1.96	0.69	0.31
FUS 41D/2,5 - 6 m	504459	4.89	6.00	35.01	17.90	8.76	8.78	6.58	3.28	1.96
FUS 62D/2,5 - 6 m	504460	6.55	8.09	111.00	25.80	17.90	12.58	13.45	6.72	4.47

1) Delivery time on request.

Load case 1

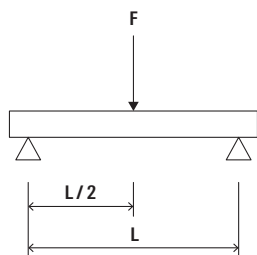

Load case 2

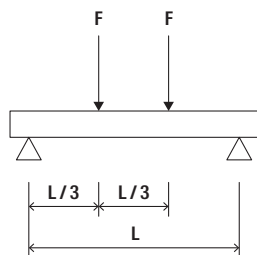

Load case 3

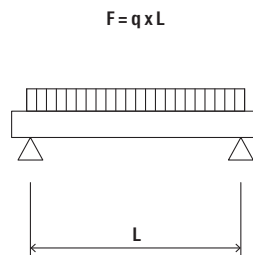

FUS 21/1,5

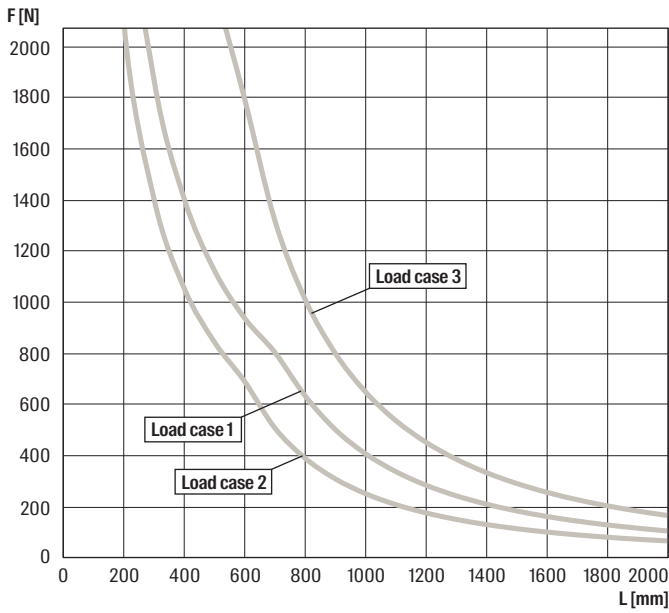

FUS 21/2,0

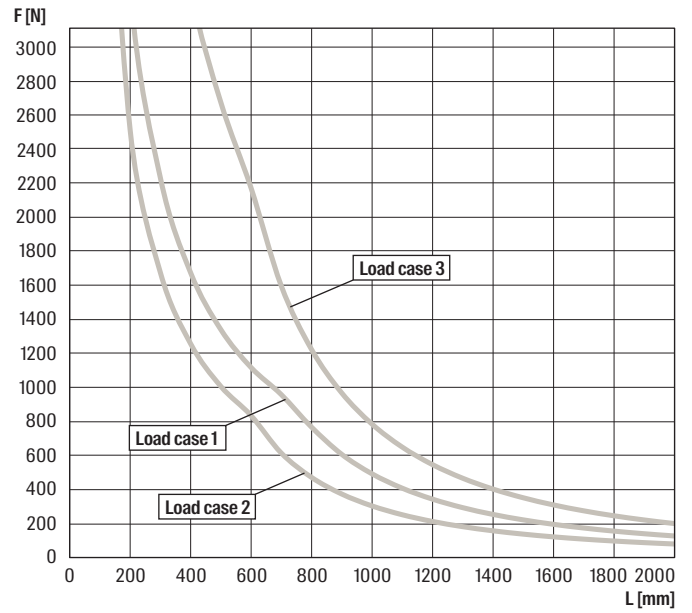

For the load curves, the permissible steel strain $\delta_{adm.} = 188 \text{ N/mm}$ and the maximum deflection under load $L/200$ are not exceeded. Fixings and screw fastenings must be calculated accordingly. The increased yield strength is calculated according DIN EN 1993-1-3:2010-12, sec. 3.2.2.

FUS 21/2,5

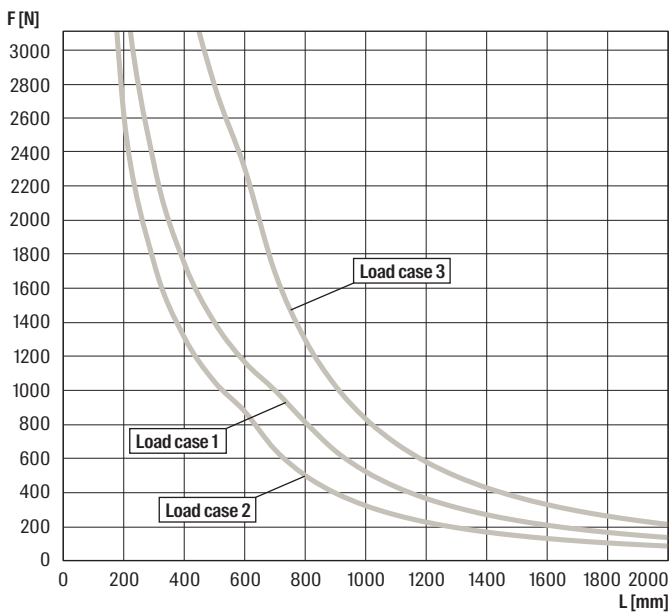

FUS 41/1,5

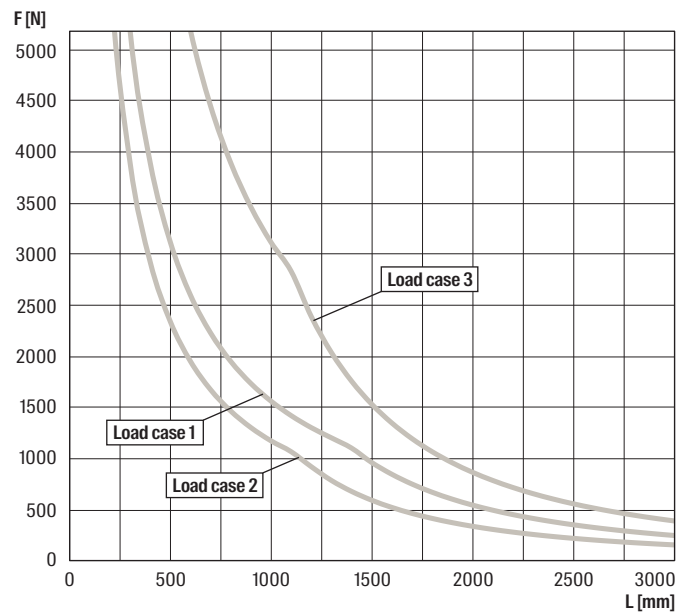

For the load curves, the permissible steel strain $\delta_{adm.} = 188 \text{ N/mm}$ and the maximum deflection under load $L/200$ are not exceeded. Fixings and screw fastenings must be calculated accordingly. The increased yield strength is calculated according DIN EN 1993-1-3:2010-12, sec. 3.2.2.

2c

FUS 41/2,0

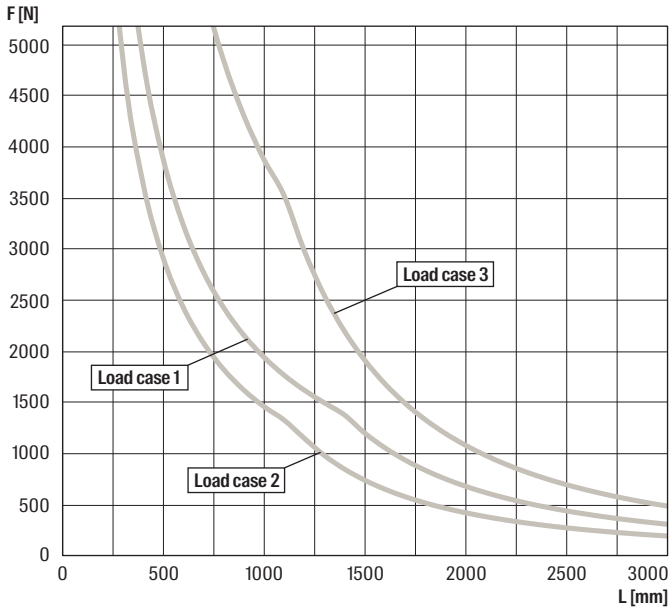

FUS 41/2,5

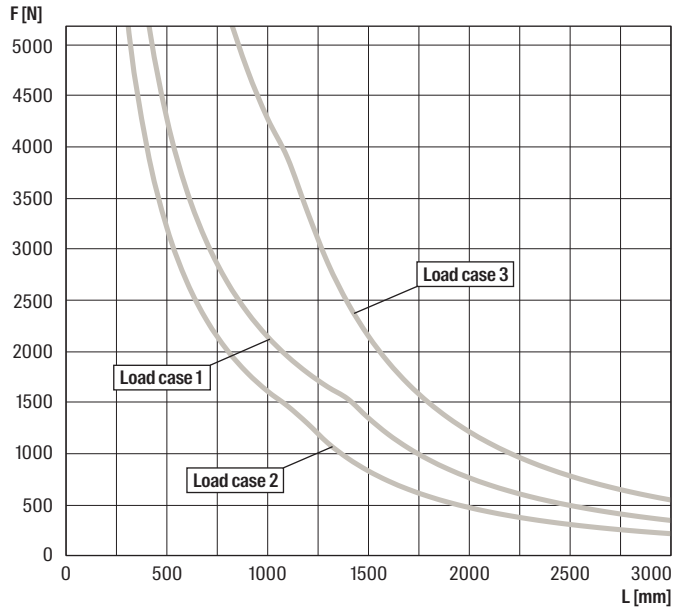

For the load curves, the permissible steel strain $\delta_{adm.} = 188 \text{ N/mm}$ and the maximum deflection under load $L/200$ are not exceeded. Fixings and screw fastenings must be calculated accordingly. The increased yield strength is calculated according DIN EN 1993-1-3:2010-12, sec. 3.2.2.

FUS 62/2,5

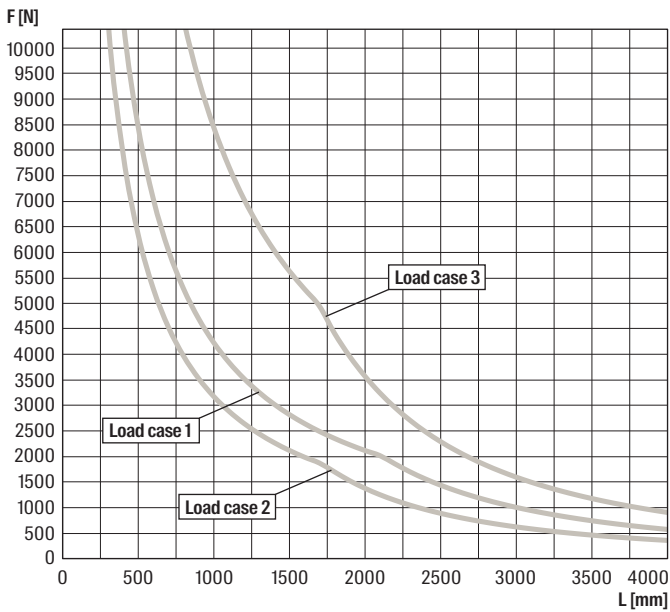

FUS 21D/2,0

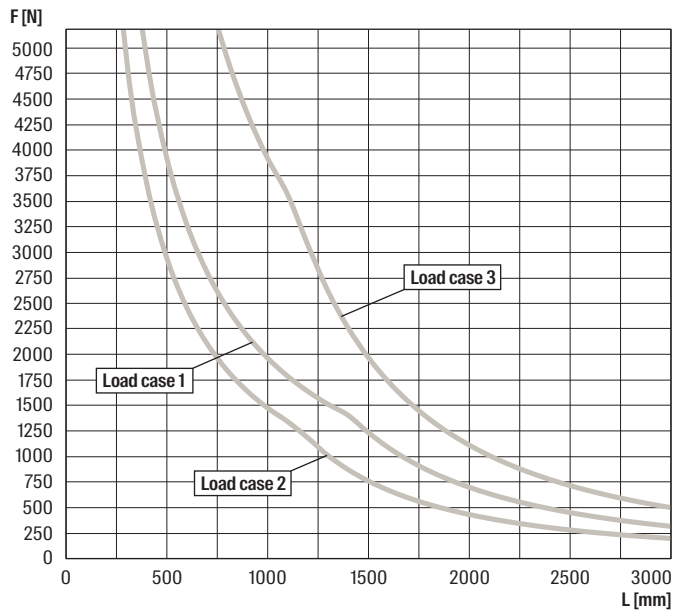

For the load curves, the permissible steel strain $\delta_{adm.} = 188 \text{ N/mm}$ and the maximum deflection under load $L/200$ are not exceeded. Fixings and screw fastenings must be calculated accordingly. The increased yield strength is calculated according DIN EN 1993-1-3:2010-12, sec. 3.2.2.

2c

FUS 41D/2,5

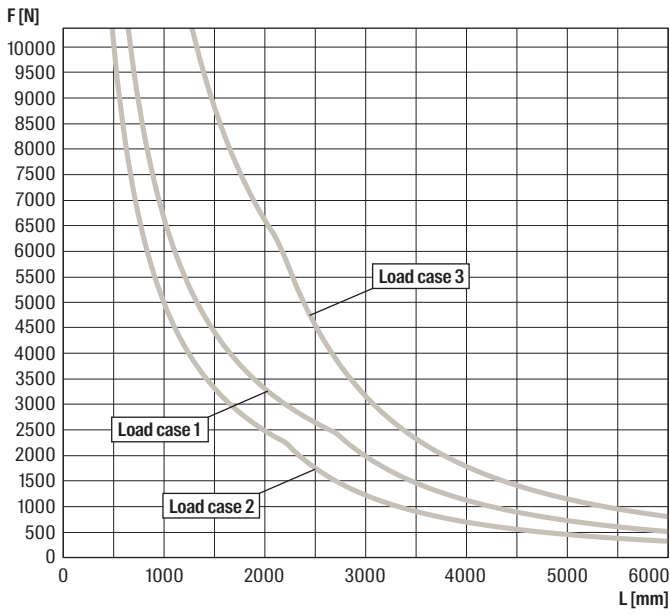

FUS 62D/2,5

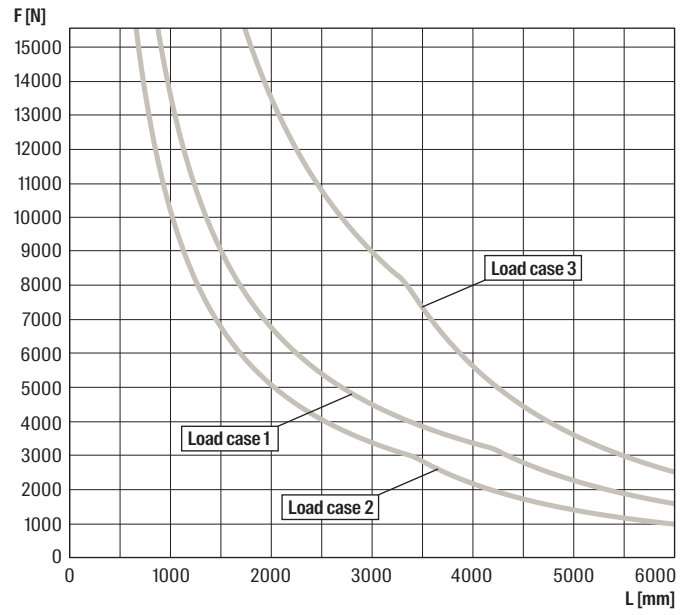

For the load curves, the permissible steel strain $\delta_{adm.} = 188 \text{ N/mm}$ and the maximum deflection under load $L/200$ are not exceeded. Fixings and screw fastenings must be calculated accordingly. The increased yield strength is calculated according DIN EN 1993-1-3:2010-12, sec. 3.2.2.

2c

Channel connector FDCC

Channel connector for easy preparation of FUS double channels

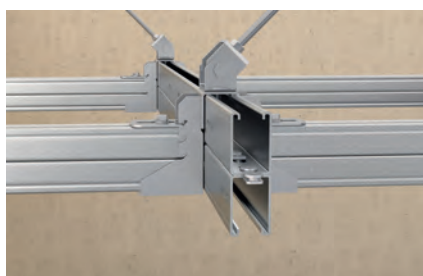

FUS double channel with channel connector

2c

Applications

- Easy construction of double channels made from the FUS channel assortment.
- Suitable for FUS channels FUS 41 and FUS 62 with thickness 2,0 and 2,5 mm.
- The connection of two single channels is made with the channel connector inside the channel slots.
- Each double channel has to be equipped with an FDCC at both ends and additional FDCCs in the given installation distance as per load chart.

Advantages/Benefits

- Easy connection of single channels back to back to built double channels.
- Simple solution to create individual double channels on job site.
- For dry inside environment.

Properties

- Material base plate: JIS G3131-SPHE (similar to DD13 according to DIN EN 10111, material no.: 1.0335)
- Material screw: steel grade 8.8
- Zinc plating: electro zinc-plated, min. 5 µm

Technical data

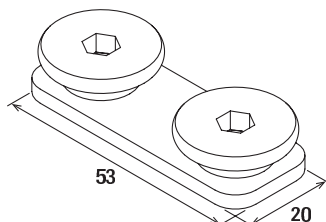

FDCC

Item	Item No.	Thread A	Drive	Tightening torque T_{inst} [Nm]	Sales unit [pcs]
FDCC	546148	M 10	Hexagon socket 5 mm	25	100

FUS 41D/2,0 - 2,5

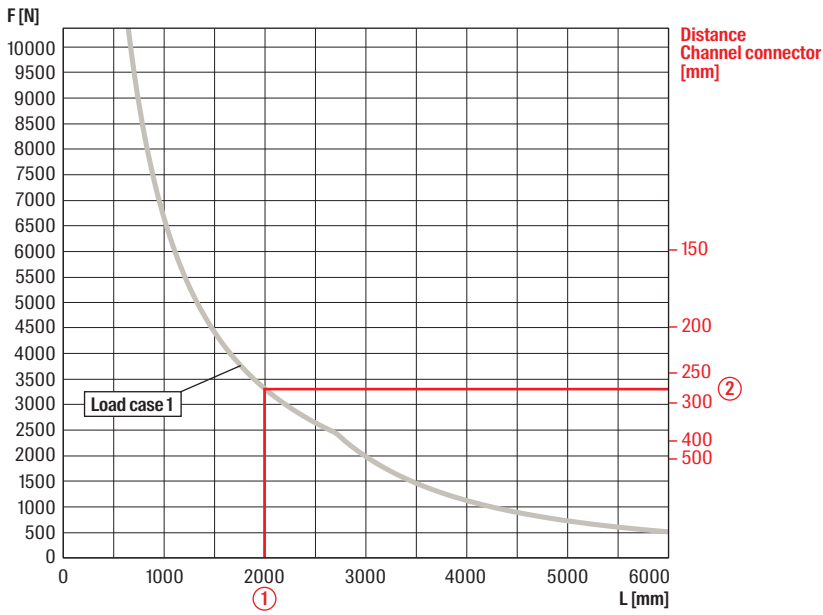

- ① Length of channel, i.e. 2000 mm for loadcase 1 (single load centric)
- ② Distance of channel connector (for intermediate values use the lower value, i.e. 250 mm)

FUS 62D/2,5

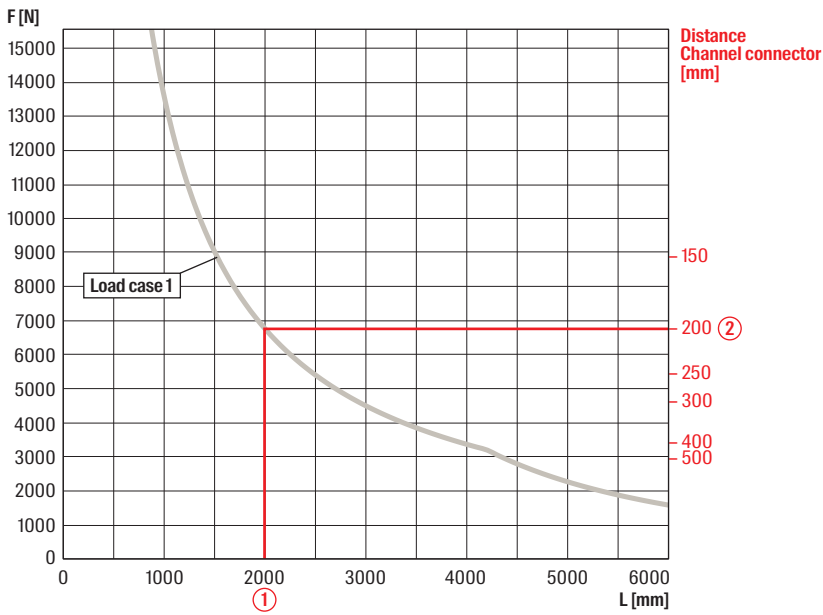

- ① Length of channel, i.e. 2000 mm for loadcase 1 (single load centric)
- ② Distance of channel connector (for intermediate values use the lower value, i.e. 250 mm)

Load case 1

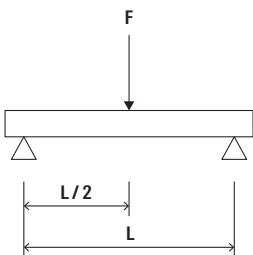

Cantilever arm FCA

FUS profiles with welded base plate for direct mounting on the base material

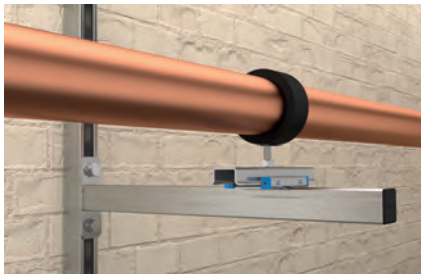

Refrigerant pipe clamp on sliding element



Heavy pipe on cantilever

Applications

- Quick and easy installation of pipelines (e.g. along the wall)

Certificates



Fire resistance classification
R120



MLAR R30

Advantages/benefits

- The fire inspection report in line with MLAR/EN13501 guarantees independently tested functional safety.
- The graduated range of lengths allows for an ideal adaptation to the application.
- The arm's solid base plate offers a secure hold for load-bearing construction.
- The base plate's long slots, which are at 90° to one another, allow the arm to be easily aligned.
- The stamped teeth in the channel gives the sliding nuts a secure hold for high shear loads, e.g. for vertical installation.

Properties

- Material: steel S235 JR (material no.: 1.0037) acc. to DIN EN 10025
- Zinc plating: electro zinc-plated, min. 8 µm

Technical data

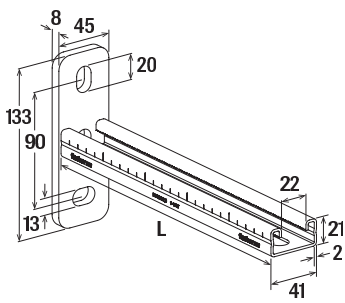

FCA 21

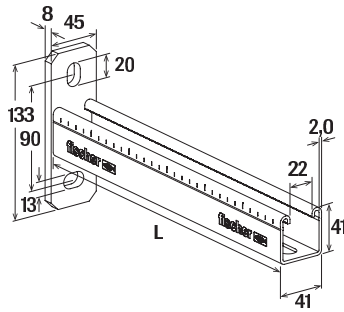

FCA 41/2,0

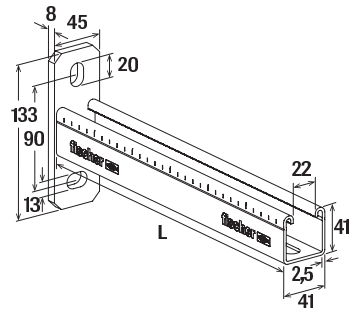

FCA 41

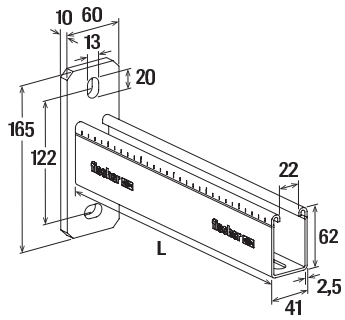

FCA 62

Item	Item No.	Fire test report	Profile	Length L [mm]	Sales unit [pcs]
FCA 21 - 200	537207	—	21/2,0	200	1
FCA 21 - 300	537208	—	21/2,0	300	1
FCA 21 - 450	537209	—	21/2,0	450	1
FCA 41/2,0 - 300	559915	—	41/2,0	300	1
FCA 41/2,0 - 450	559916	—	41/2,0	450	1
FCA 41/2,0 - 600	559917	—	41/2,0	600	1
FCA 41/2,0 - 750	559918	—	41/2,0	750	1
FCA 41/2,0 - 1000	559919	—	41/2,0	1000	1
FCA 41 - 300	077359	X	41/2,5	300	1
FCA 41 - 450	077361	X	41/2,5	450	1
FCA 41 - 600	077363	X	41/2,5	600	1
FCA 41 - 750	077365	X	41/2,5	750	1
FCA 62 - 1000	504315	X	62/2,5	1000	1

Technical data

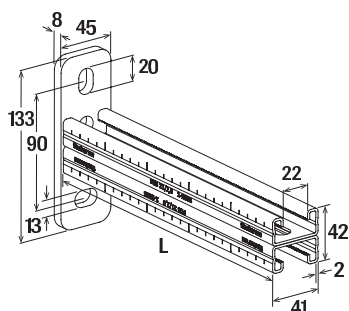

FCA 21D

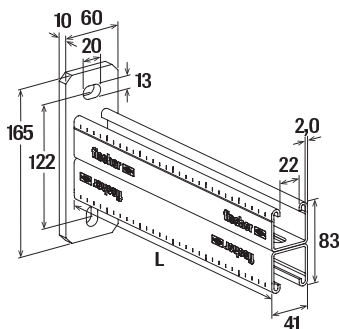

FCA 41D/2,0

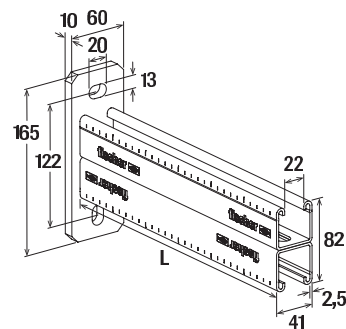

FCA 41D

Item	Item No.	Fire test report	Profile	Length L [mm]	Sales unit [pcs]
FCA 21D - 300	536978	—	21D/2,0	300	1
FCA 21D - 450	536979	—	21D/2,0	450	1
FCA 21D - 600	536980	—	21D/2,0	600	1
FCA 41D/2,0 - 750	559920	—	41D/2,0	750	1
FCA 41D/2,0 - 1000	559921	—	41D/2,0	1000	1
FCA 41D - 750	504317	—	41D/2,5	750	1
FCA 41D - 1000	504319	—	41D/2,5	1000	1

Loads

Item	Item No.	Max. recommended static load load case 1	Max. recommended static load load case 2	Max. recommended static load load case 3
		F_{rec} [kN]	F_{rec} [kN]	F_{rec} [kN]
FCA 21 - 200	537207	1.43	0.72	1.43
FCA 21 - 300	537208	0.95	0.45	0.95
FCA 21 - 450	537209	0.65	0.21	0.65
FCA 41/2,0 - 300	559915	1.8	0.9	1.8
FCA 41/2,0 - 450	559916	1.2	0.6	1.2
FCA 41/2,0 - 600	559917	0.9	0.45	0.9
FCA 41/2,0 - 750	559918	0.72	0.36	0.72
FCA 41/2,0 - 1000	559919	0.54	0.23	0.54
FCA 41 - 300	077359	1.8	0.9	1.8
FCA 41 - 450	077361	1.2	0.6	1.2
FCA 41 - 600	077363	0.9	0.45	0.9
FCA 41 - 750	077365	0.72	0.36	0.72
FCA 62 - 1000	504315	1.25	0.62	1.25
FCA 21D - 300	536978	1.83	0.92	1.83
FCA 21D - 450	536979	1.24	0.62	1.24
FCA 21D - 600	536980	0.92	0.46	0.92
FCA 41D/2,0 - 750	559920	2.5	1.25	2.5
FCA 41D/2,0 - 1000	559921	1.9	0.93	1.9
FCA 41D - 750	504317	2.5	1.25	2.5
FCA 41D - 1000	504319	1.9	0.93	1.9

Load case 1

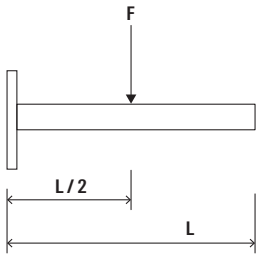

Load case 2

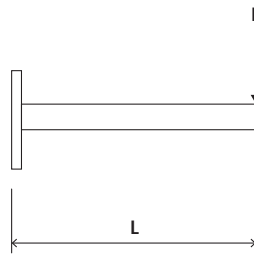

Load case 3

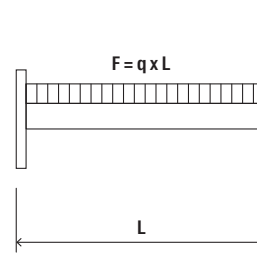

FCA 21

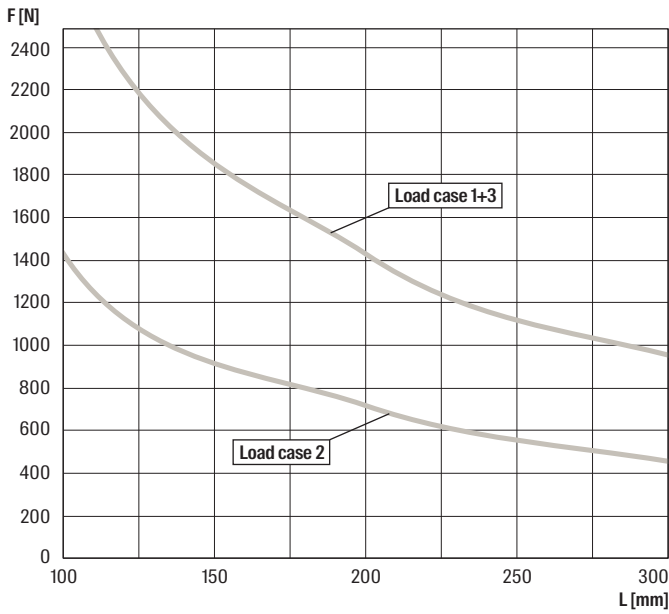

FCA 41

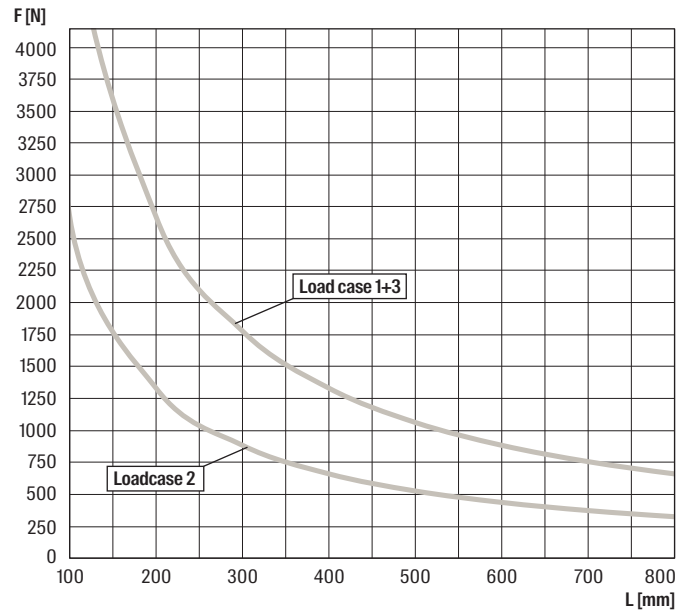

For the load curves, the permissible steel strain $\delta_{adm.} = 160$ N/mm and the maximum deflection under load $L/150$ are not exceeded. Load values of the cantilever arms under consideration of the load capacity of the base plate. Fixings and screw fastenings must be calculated accordingly.

FCA 62

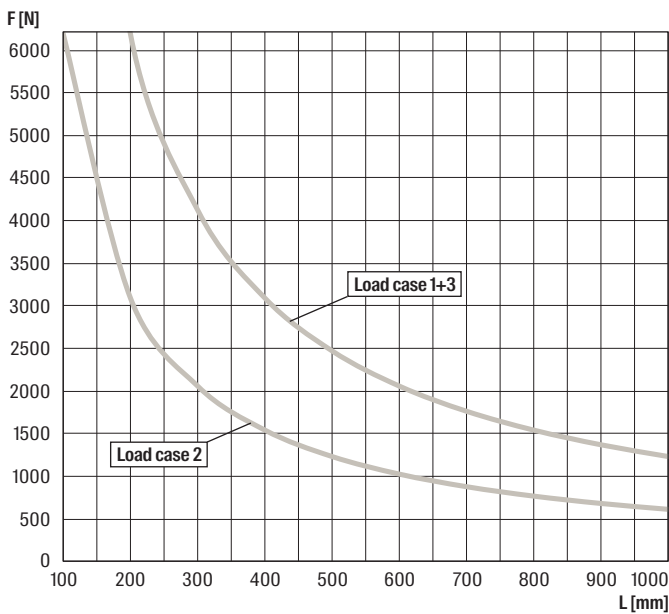

For the load curves, the permissible steel strain $\delta_{adm.} = 160$ N/mm and the maximum deflection under load $L/150$ are not exceeded. Load values of the cantilever arms under consideration of the load capacity of the base plate. Fixings and screw fastenings must be calculated accordingly.

2c

FCA 21D

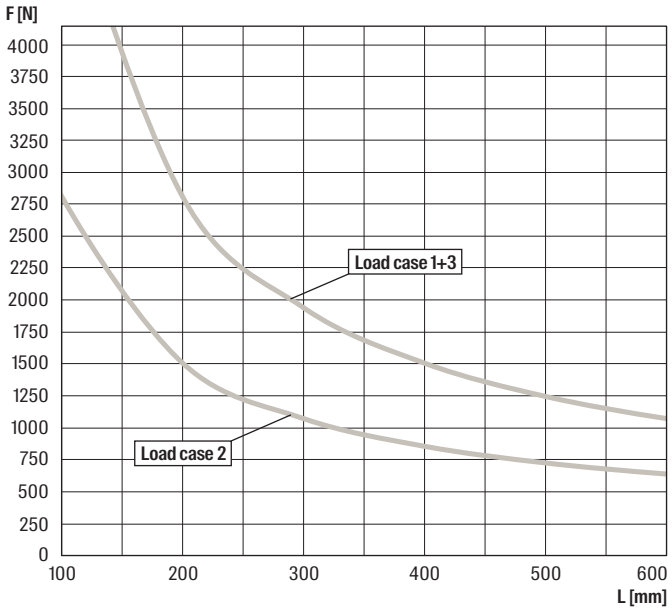

FCA 41D

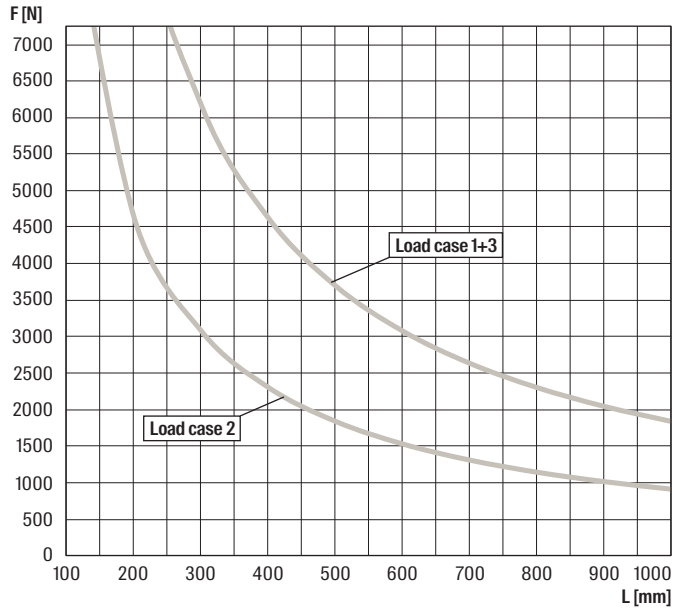

For the load curves, the permissible steel strain $\delta_{adm.} = 160$ N/mm and the maximum deflection under load $L/150$ are not exceeded. Load values of the cantilever arms under consideration of the load capacity of the base plate. Fixings and screw fastenings must be calculated accordingly.

Large cantilever arm FCAM

The large cantilever arm for heavy loads



Sliding element on cantilever



Upright pipe on cantilever arm

2c

Applications

- Quick and easy installation of pipelines with heavy loads, (e.g. along the wall)

Advantages/benefits

- The robust construction, consisting of a basic and a support profile, allows for the bearing of heavy loads.
- The graduated range of lengths allows for an ideal adaptation to the application.
- The base plate's long slots, which are at 90° to one another, allow the arm to be easily aligned.
- The stamped teeth in the channel gives the sliding nuts a secure hold for high shear loads, e.g. for vertical installation.

Properties

- Material: steel S235 JR (material no.: 1.0037) acc. to DIN EN 10025
- Zinc plating: electro zinc-plated, min. 8 µm

Technical data

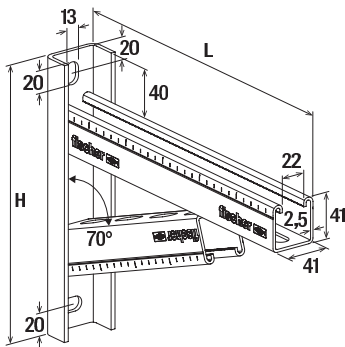

FCAM

Item	Item No.	Length L ₁ [mm]	Height H [mm]	Sales unit [pcs]
FCAM 300	504477	300	246	1
FCAM 400	504479	400	270	1
FCAM 500	504480	500	284	1
FCAM 600	504482	600	319	1
FCAM 700	505460	700	343	1

Loads

Item	Item No.	Max. recommended static load load case 1 F_{rec} [kN]	Max. recommended static load load case 2 F_{rec} [kN]	Max. recommended static load load case 3 F_{rec} [kN]
FCAM 300	504477	7.0	3.7	7.0
FCAM 400	504479	7.5	2.8	7.5
FCAM 500	504480	6.5	2.3	6.5
FCAM 600	504482	6.0	1.9	6.0
FCAM 700	505460	5.5	1.3	5.5

2c

Load case 1

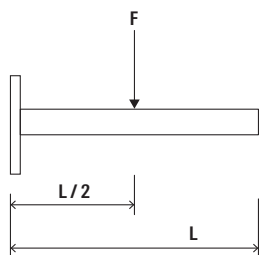

Load case 2

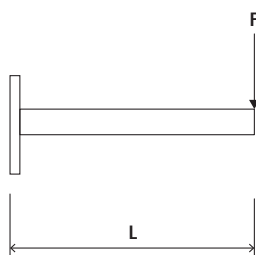

Load case 3

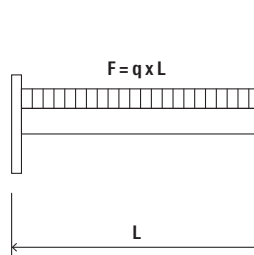

Cover cap FEC



FEC 21 B



FEC 41 B



FEC 62 B

Item	Item No.	For profile	Material	Sales unit [pcs]
FEC 21 B	077357	41/21	Polyethylene, black	100
FEC 41 B	077355	41/41	Polyethylene, black	100
FEC 62 B	505551	41/62	Polyethylene, black	100

Push-through connector PFCN

Push-through connector for the quickest and easiest connection of FUS profiles



Cross connection on channel



Cantilever with saddle flange

2c

Applications

- Connection of FUS channels and construction elements by push-through principle
- Universal fitting for all push-through connection elements and FUS profiles

Advantages/benefits

- The correct fit of the push-through connector and connection elements allows the quickest and easiest channel connection.
- The spring effect of the PFCN in set state guarantees a simple and precise positioning in the channel.
- The teeth on the push through connector provide a secure hold in the FUS channel.
- Installation by rotating 90° enables generally the post-installation in set channels.

Properties

- Material Cap: steel DD11 (material no. 1.0332) acc. to DIN EN 10111
- Material Sliding nut: steel S420MC, EN 10149-2
- Material Hexagon screw: 8.8 M10-28, DIN 933
- Material Plastic parts: polypropylene
- Zinc plating: electro zinc-plated acc. to DIN 50979, min. 8 µm

Installation PFCN 41

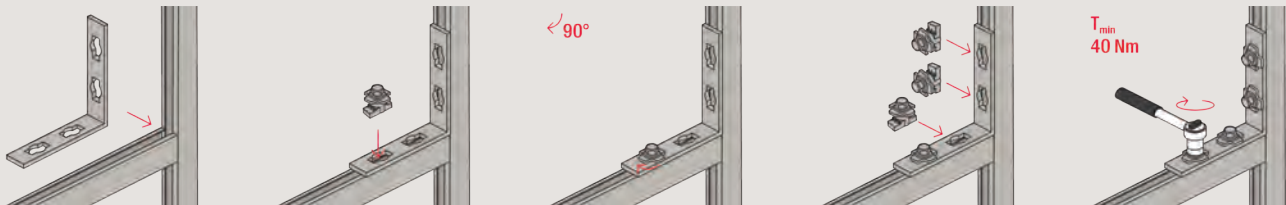

Technical data

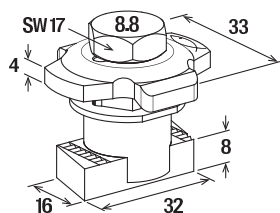

PFCN

Item	Item No.	Thread A	Sales unit [pcs]
PFCN 41	533739	M 10	50

Loads

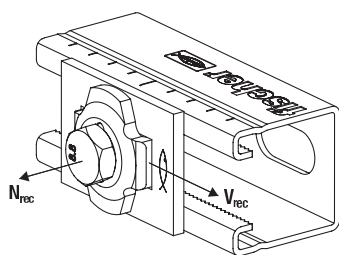

PFCN 41

Item	Item No.	Max. recommended tension load for FUS 1,5 mm N_{rec} [kN]	Max. recommended tension load for FUS 2,0 mm N_{rec} [kN]	Max. recommended tension load for FUS 2,5 mm N_{rec} [kN]	Max. recommended shear load for FUS 1,5 mm V_{rec} [kN]	Max. recommended shear load for FUS 2,0 mm [kN]	Max. recommended shear load for FUS 2,5 mm [kN]	Tightening torque for screw grade ≥ 8.8 T_{inst} [Nm]
PFCN 41	533739	4.0	5.0	7.0	4.0	4.5	5.0	40

Saddle flange PSF

Construction element - Saddle flange PSF



Pipe installation in escape route



Cantilever with saddle flange

2c

Applications

- Stable construction of connections between channels and building structures for the push-through system

Advantages/benefits

- The perfect-fit saddle allows a simple installation by inserting the mounting channels
- The saddle flange's stable design offers a secure hold for a load-bearing construction

Properties

- Material: steel DD11 (material no. 1.0332) acc. to DIN EN 10111
- Zinc plating: electro zinc-plated acc. to DIN 50979, min. 8 µm

Technical data

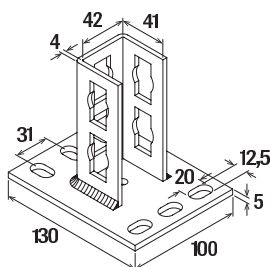

PSF 41

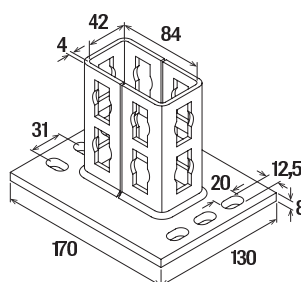

PSF 82

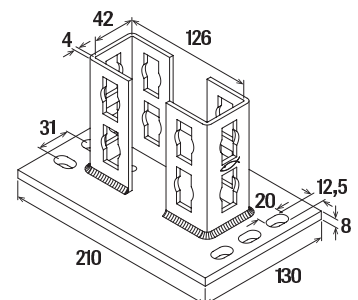

PSF 124

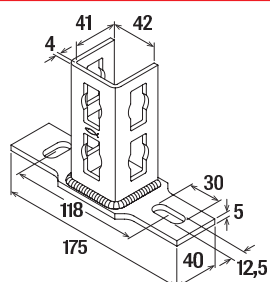

PSFQ 41

Item	Item No.	For profile	Sales unit
			[pcs]
PSF 41	533740	21D, 41, 62	10
PSF 82	533741	41 D	5
PSF 124	533742	62 D	5
PSFQ 41	535266	41	10

Loads

See Push-through connector PFCN

Universal bracket PUWS

Construction element - Universal bracket PUWS

2c

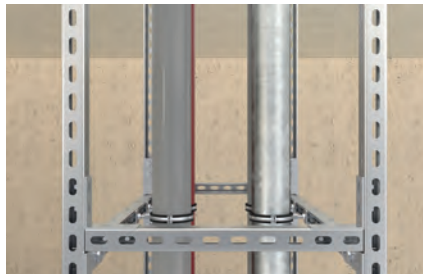

3D-frame constructions



Support systems for ventilation

Applications

- Reinforcement of supporting structures for the push-through system

Advantages/benefits

- The universal brackets for the connection of FUS channels gives a supporting structure, great stability and safety (we recommend using in pairs).

Properties

- Material: steel DD11 (material no. 1.0332) acc. to DIN EN 10111
- Zinc plating: electro zinc-plated acc. to DIN 50979, min. 8 µm

Technical data

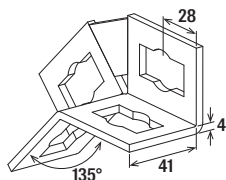

PUWS 2 x 2/135°

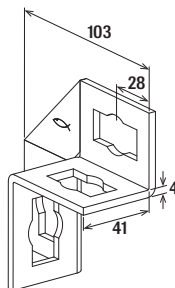

PUWS 2 x 2

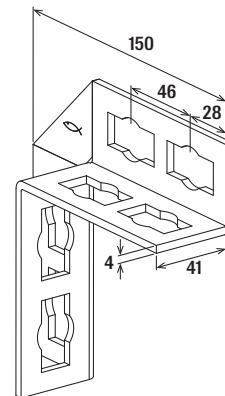

PUWS 4 x 4

Item	Item No.	Sales unit
		[pcs]
PUWS 2 x 2/135°	533731	10
PUWS 2 x 2	533733	10
PUWS 4 x 4	533734	8

Loads

See Push-through connector PFCN

Angle bracket PWK

Construction element - Angle bracket PWK



Solid frame construction

Applications

- Reinforcement in the push-through system and for lateral fixing to the substrate

Advantages/benefits

- The stable angle bracket ensures a supporting structure with a very high level of stability and safety.

Properties

- Material: steel DD11 (material no. 1.0332) acc. to DIN EN 10111
- Zinc plating: electro zinc-plated acc. to DIN 50979, min. 8 µm

Technical data

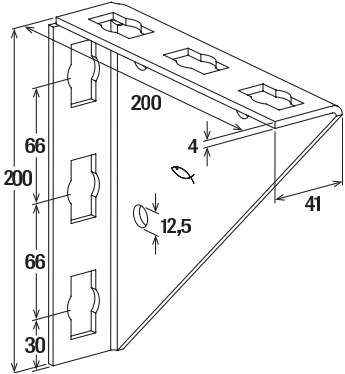

PWK 200

Item	Item No.	Sales unit
		[pcs]
PWK 200/200	533744	15

Loads

See Push-through connector PFCN

Variable bracket PVB

Construction element – Variable bracket PVB

2c



Massive bracing of cantilever arm

Applications

- Variable angular positioning of profile support in the push-through system
- Bracket for installation with FUS channels from 0° to 180°

Advantages/Benefits

- The design of the variable bracket PVB enables the fixation of mounting channels at an angle of 0° to 180°.
- The holes in the connecting element make it compatible with the push-through connector PFCN.
- The punched holes in the base plate allow the direct fixing onto a wall, ceiling or onto a mounting channel by screw or anchor.

Properties

- Material: steel DD11 (material no. 1.0332) acc. to DIN EN 10111
- Zinc plating: electro zinc-plated acc. to DIN 50979, min. 8 µm

Technical data

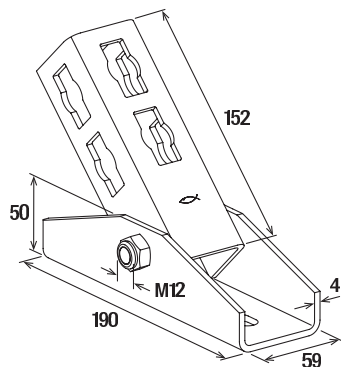

PVB

Item	Item No.	Sales unit
		[pcs]
PVB	534960	5

Loads

See Push-through connector PFCN

Bracing elements PSAE

Construction elements – Bracing elements PSAE 300 and 500



Supported channel

Applications

- Elements for stable cantilever constructions made of FUS channels or FCA cantilever arms with push-through connector PFCN

Advantages/benefits

- The stable bracing element PSAE gives the supporting structure very high stability and safety.
- The holes in the base plate of the element make it compatible with the push-through connector PFCN.
- An additional PU-washer allows for fixing of elements with formholes directly onto a wall or ceiling by anchor or screw.

Properties

- Material: steel P235TR2 (material no. 1.0255) acc. to EN 10216-1
- Zinc plating: electro zinc-plated acc. to DIN 50979, min. 8 µm

Installation PSAE

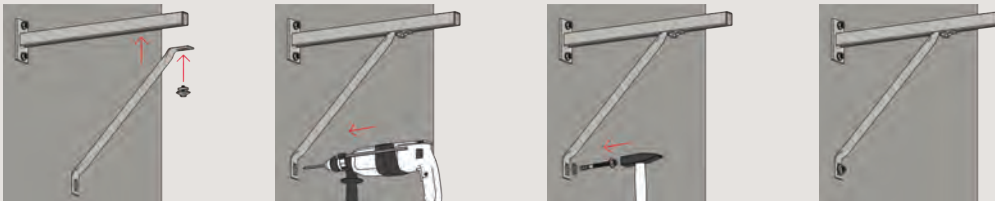

Technical data

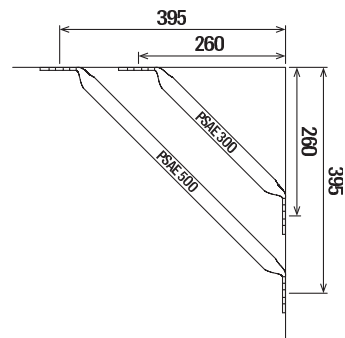
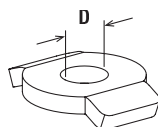
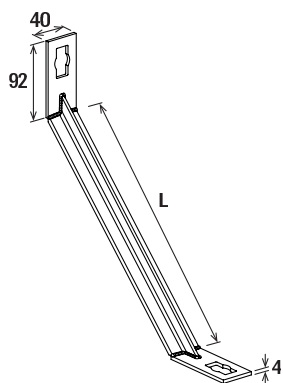

2c

PSAE

PU

PSAE 300 and PSAE 500

Item	Item No.	Length L [mm]	Sales unit [pcs]
PSAE 300 Brace element	535269	300	10
PSAE 500 Brace element	535270	500	10
PU 10,5 Washer	535271	—	50
PU 12,5 Washer	535272	—	50

Loads

See Push-through connector PFCN

Channel connector FUF OC and PFUF OC

Construction element - Channel connector FUF OC and PFUF OC



Connector for installation grid

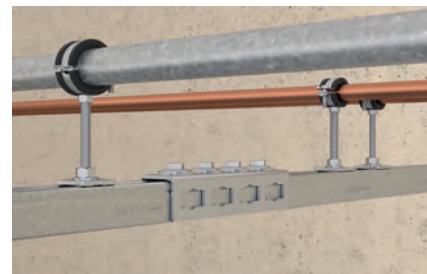

Longitudinal channel connection

2c

Applications

- Connection and precise alignment of channel

Advantages/benefits

- The FUF OC connector in combination with FCN Clix P allows a simple and time-saving installation.
- The PFUF OC connector in combination with PFCN allows a simple and time-saving installation.

Properties

- Material FUF OC: steel S235 JR (material no. 1.0037) acc. to DIN EN 10025
- Zinc plating FUF OC: electro zinc-plated, min. 5 µm
- Material PFUF OC: steel DD11 (material no. 1.0332) acc. to DIN EN 10111
- Zinc plating PFUF OC: electro zinc-plated acc. DIN 50979, min. 8 µm

Technical data

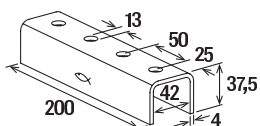

FUF OC 41

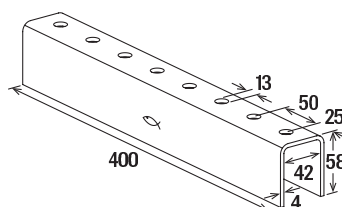

FUF OC 62

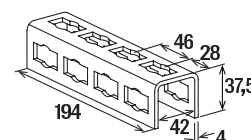

PFUF OC

Item	Item No.	Length L [mm]	Sales unit [pcs]
FUF OC 41	504517	200	20
FUF OC 62	504518	400	10
PFUF OC	533743	194	6

Bracket PFFF

Construction elements - Brackets PFFF

2c

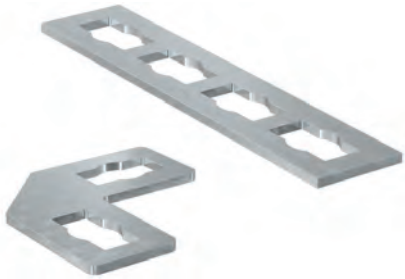

Waste water pipe

Applications

- Arrangement of simple channel constructions in the push-through system

Advantages/benefits

- The holes in the connecting elements make them compatible with the push-through connector PFCN.

Properties

- Material: steel DD11 (material no. 1.0332) acc. to DIN EN 10111
- Zinc plating: electro zinc-plated acc. to DIN 50979, min. 8 µm

Technical data

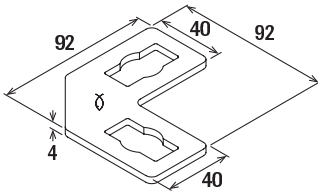

PFFF 2L

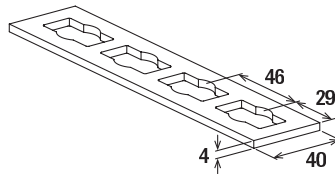

PFFF 4I

Item	Item No.	Sales unit
		[pcs]
PFFF 2L	533745	20
PFFF 4I	535268	25

Loads

See Push-through connector PFCN

Bracket PFAF

Construction elements - Brackets PFAF

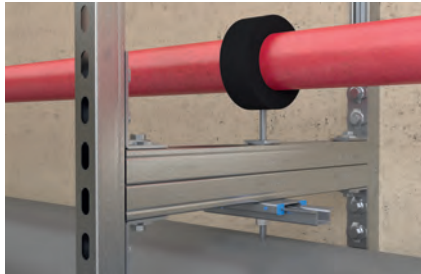

Frame constructions

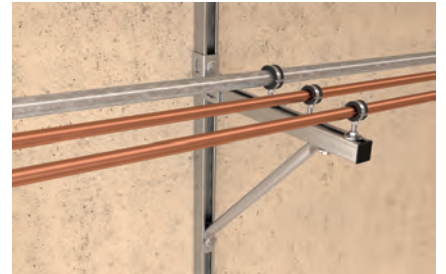

Leightweight installation on cantilever

2c

Applications

- Arrangement of simple channel constructions in the push-through system

Advantages/benefits

- The holes in the connecting elements make them compatible with the push-through connector PFCN.

Properties

- Material: steel DD11 (material no. 1.0332) acc. to DIN EN 10111
- Zinc plating: electro zinc-plated acc. to DIN 50979, min. 8 µm

Technical data

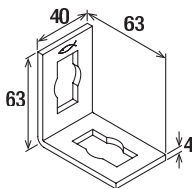

PFAF 2

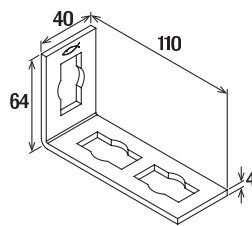

PFAF 3

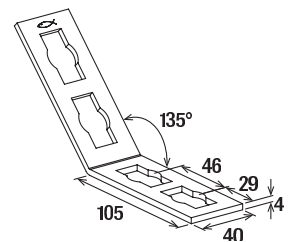

PFAF 4/135°

Item	Item No.	Sales unit
		[pcs]
PFAF 2	533735	25
PFAF 3	533736	25
PFAF 4/135°	533737	20

Technical data

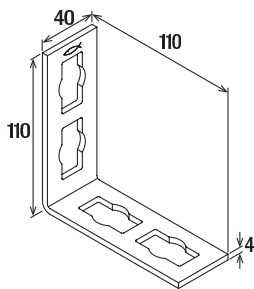

PFAF 4

2c

Item	Item No.	Sales unit
		[pcs]
PFAF 4	535267	25

Loads

See Push-through connector PFCN

Bracket PFUF

Construction elements - Brackets PFUF

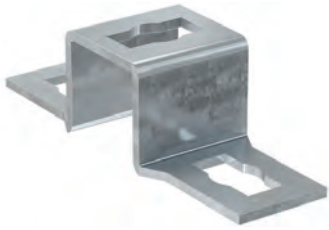

Cross connection on channel

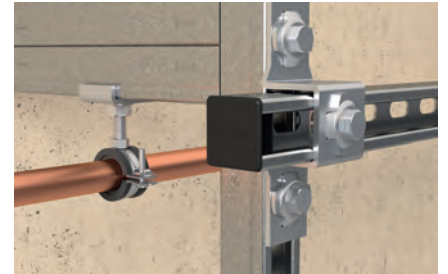

Cross connection on channel

2c

Applications

- Connecting elements for multi-dimensional channel constructions

Advantages/benefits

- The various shapes of the connecting elements offer flexibility during the installation of channel constructions.
- The holes in the connecting elements make them compatible with the push-through channel nut PFCN.

Properties

- Material: steel DD11 (material no. 1.0332) acc. to DIN EN 10111
- Zinc plating: electro zinc-plated acc. to DIN 50979, min. 8 µm

Technical data

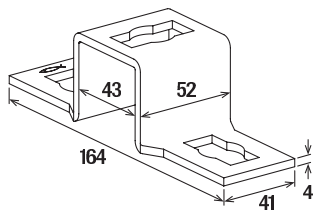

PFUF 41

Item	Item No.	Sales unit
		[pcs]
PFUF 41	533738	25

Loads

See Push-through connector PFCN

Brackets PFUF D

Construction elements - Bracket PFUF 3D and 4D

2c

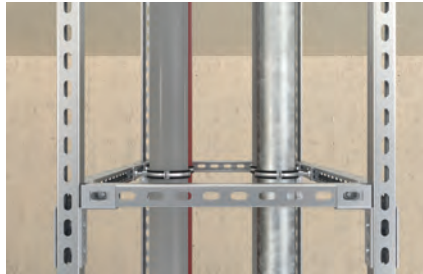
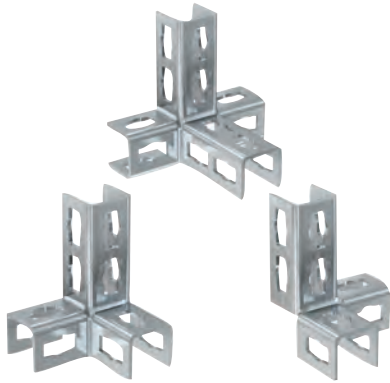

Frame constructions

Applications

- Element for multidimensional constructions with FUS channels connected by the push-through connector PFCN

Advantages/Benefits

- The 3D PFUF construction elements enable multidimensional constructions in a very short time.
- The holes in the construction elements make them compatible with the push-through connector PFCN.
- The different shapes of the construction elements generate a high flexibility for channel constructions.

Properties

- Material: steel DD11 (material no. 1.0332) acc. to DIN EN 10111
- Zinc plating: electro zinc-plated acc. to DIN 50979, min. 8 µm

Technical data

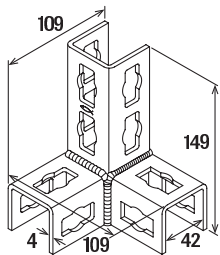

PFUF 3DL

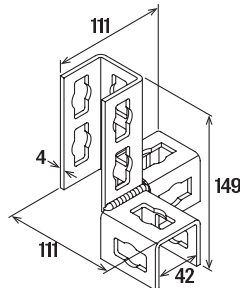

PFUF 3DR

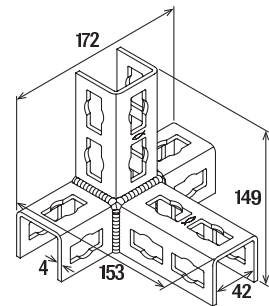

PFUF 4D

Item	Item No.	Sales unit
		[pcs]
PFUF 3DL	535273	10
PFUF 3DR	535274	10
PFUF 4D	535275	10

Loads

See Push-through connector PFCN

Connector FCN Clix P and FCN Clix M

Channel nut for quick and easy fixing in FUS profiles

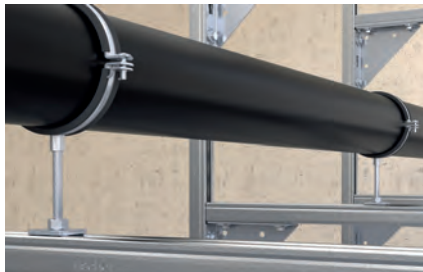
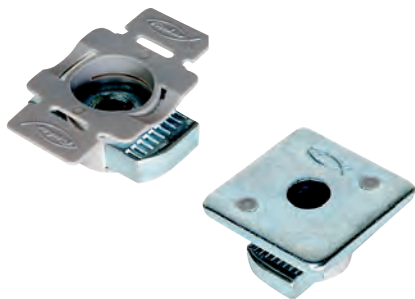

Connection on channel

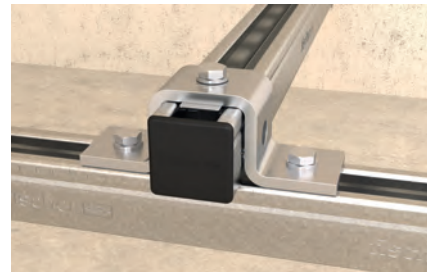

Cross connection

2c

Applications

- FCN Clix P: connection of FUS channels and fixtures
- FCN Clix M: connection of pipe clamps to FUS channel under the use of threaded rods

Certificates



Fire resistance classification
R120



MLAR R30

Advantages/benefits

- The sliding nut design enables a quick and easy setting in the channel.
- The spring effect of the plastic clasp guarantees simple and precise positioning in the channel.
- The FCN Clix P's flat plastic mounting with wings offers a good hold and a convenient mounting.
- The teeth on the sliding nut provide a secure hold in the FUS channel.
- Installation by rotating 90° enables post-installation in installed channel.

Properties

- Material: steel S235 JR (material no. 1.0037) acc. to DIN EN 10025, plastic Nylon PA6
- Zinc plating: electro zinc-plated, min. 5 µm

Installation FCN Clix P

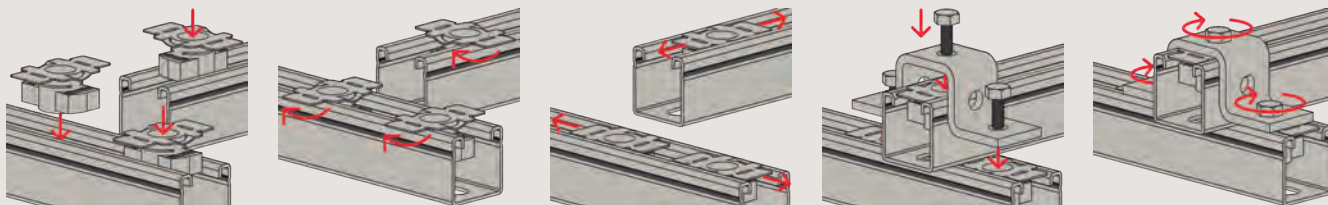

Installation FCN Clix M

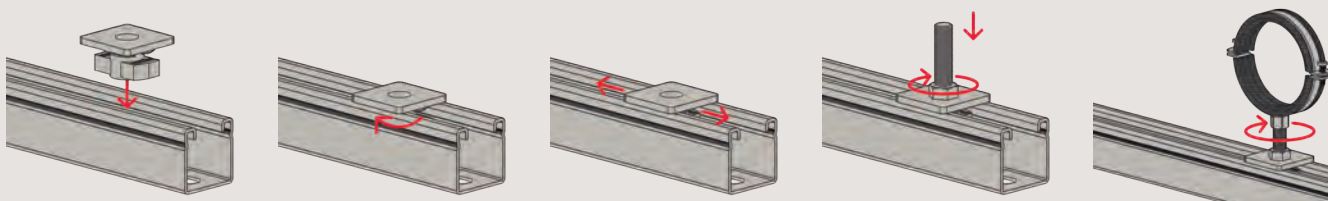

Technical data

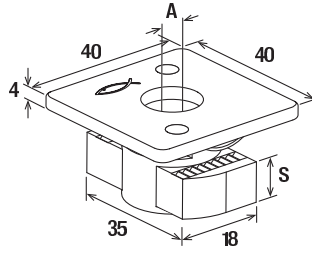
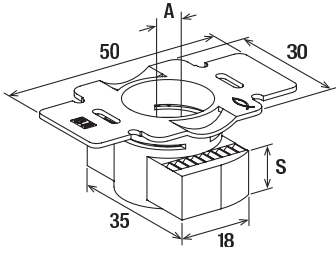

FCN Clix P

FCN Clix M

Item	Item No.	Fire test report	Thread A	Thickness S [mm]	Sales unit [pcs]
FCN Clix P 6	559757	—	M 6	6	50
FCN Clix P 8	559758	—	M 8	6	50
FCN Clix P 10	559759	X	M 10	8	50
FCN Clix P 12	559760	X	M 12	9.5	50
FCN Clix M 6	559761	—	M 6	6	50
FCN Clix M 8	559762	—	M 8	6	50
FCN Clix M 10	559763	X	M 10	8	50
FCN Clix M 12	559764	X	M 12	9.5	50

Loads

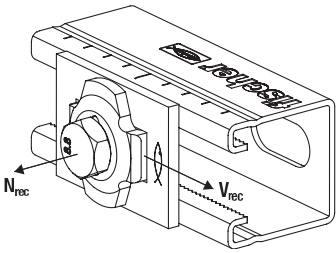

FCN Clix P and FCN Clix M

Item	Item No.	Max. recommended tension load for FUS 1,5 mm	Max. recommended tension load for FUS 2,0 mm	Max. recommended tension load for FUS 2,5 mm	Max. recommended shear load for FUS 1,5 mm	Max. recommended shear load for FUS 2,0/2,5 mm	Tightening torque for screw grade ≥ 8.8	Tightening torque for screw grade ≥ 4.6
		N_{rec} [kN]	N_{rec} [kN]	N_{rec} [kN]	V_{rec} [kN]	V_{rec} [kN]	T_{inst} [Nm]	T_{inst} [Nm]
FCN Clix P 6	559757	2.5	3.0	3.0	1.0	1.0	10	—
FCN Clix P 8	559758	3.0	4.0	4.0	1.5	2.0	20	—
FCN Clix P 10	559759	4.0	5.0	8.0	2.0	2.5	40	—
FCN Clix P 12	559760	4.0	5.0	8.0	2.0	3.0	50	—
FCN Clix M 6	559761	—	3.0	3.0	—	—	—	5
FCN Clix M 8	559762	—	4.0	4.0	—	—	—	10
FCN Clix M 10	559763	—	5.0	8.0	—	—	—	15
FCN Clix M 12	559764	—	5.0	8.0	—	—	—	20

T-head bolt FHS Clix S

Hammer-head bolt for quick and easy fixing in FUS profiles



Leightweight installation on cantilever

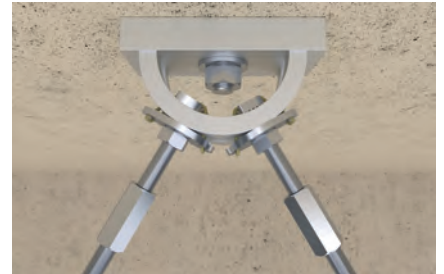

Bracings with UHRS

2c

Applications

- Connection of pipe clamps to the channel

Advantages/benefits

- The hammer-head nut design for a quick and easy setting in the channel.
- The spring effect of the plastic bands guarantees simple and precise positioning in the channel.
- Installation by rotating 90° enables post-installation in installed channel.

Properties

- Material washer: steel DC01-C490 (material no.1.0330) acc. to DIN EN 10139
- Hammer head bolt: resistance class 8.8
- Nut DIN 934: resistance class min. 4
- Zinc plating: electro zinc-plated, min. 5 µm

Installation FHS Clix S

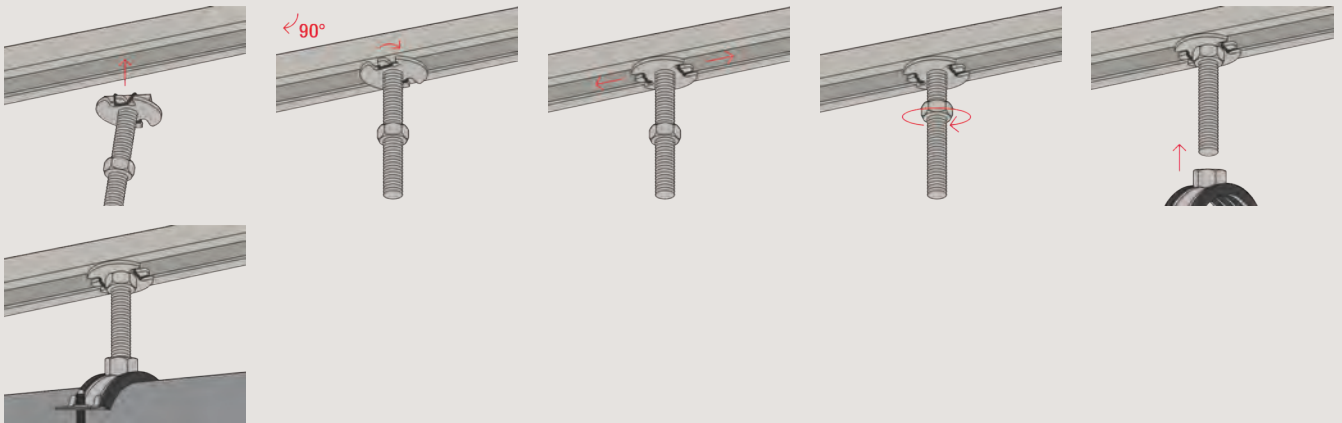

Technical data

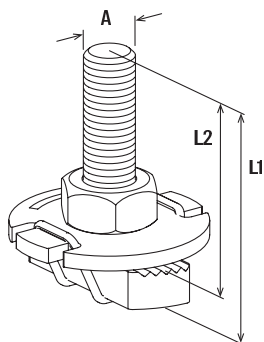

FHS Clix S

Item	Item No.	Thread A	Length L_1 [mm]	Length L_2 [mm]	Sales unit [pcs]
FHS CLIX S 8 x 30	020914	M 8	36	30	50
FHS CLIX S 8 x 40	020915	M 8	46	40	50
FHS CLIX S 8 x 60	020916	M 8	66	60	50
FHS CLIX S 10 x 30	020917	M 10	37	30	50
FHS CLIX S 10 x 40	020918	M 10	47	40	50
FHS CLIX S 10 x 60	020919	M 10	67	60	50
FHS CLIX S 12 x 30	020969	M 12	38	30	50
FHS CLIX S 12 x 40	047316	M 12	48	40	50
FHS CLIX S 12 x 60	504320	M 12	68	60	50

Loads

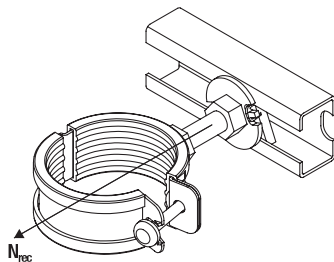

FHS Clix S

Item	Item No.	Max. recommended tension load for FUS 1,5 mm N_{rec} [kN]	Max. recommended tension load for FUS 2,0 mm N_{rec} [kN]	Max. recommended tension load for FUS 2,5 mm N_{rec} [kN]	Tightening torque T_{inst} [Nm]
FHS CLIX S 8 x 30	020914	3.0	4.0	4.0	5
FHS CLIX S 8 x 40	020915	3.0	4.0	4.0	5
FHS CLIX S 8 x 60	020916	3.0	4.0	4.0	5
FHS CLIX S 10 x 30	020917	3.0	4.0	5.0	10
FHS CLIX S 10 x 40	020918	3.0	4.0	5.0	10
FHS CLIX S 10 x 60	020919	3.0	4.0	5.0	10
FHS CLIX S 12 x 30	020969	3.0	4.0	5.0	10
FHS CLIX S 12 x 40	047316	3.0	4.0	5.0	10
FHS CLIX S 12 x 60	504320	3.0	4.0	5.0	10

T-head bolt FCSN

Hammer-head bolt for easy fixing in FUS profiles



Leightweight installation on cantilever

2c

Applications

- Connection of pipe clamps to the channel

Advantages/benefits

- The hammer-head nut design for an easy setting in the channel.
- Installation by rotating 90° enables post-installation in installed channel.

Properties

- Material washer: steel acc. to DIN EN 10139
- Hammer head bolt: steel with min. 400 N/mm²
- Material nut: strength category 4
- Zinc plating: electro zinc-plated, min. 5 µm

Installation FCSN

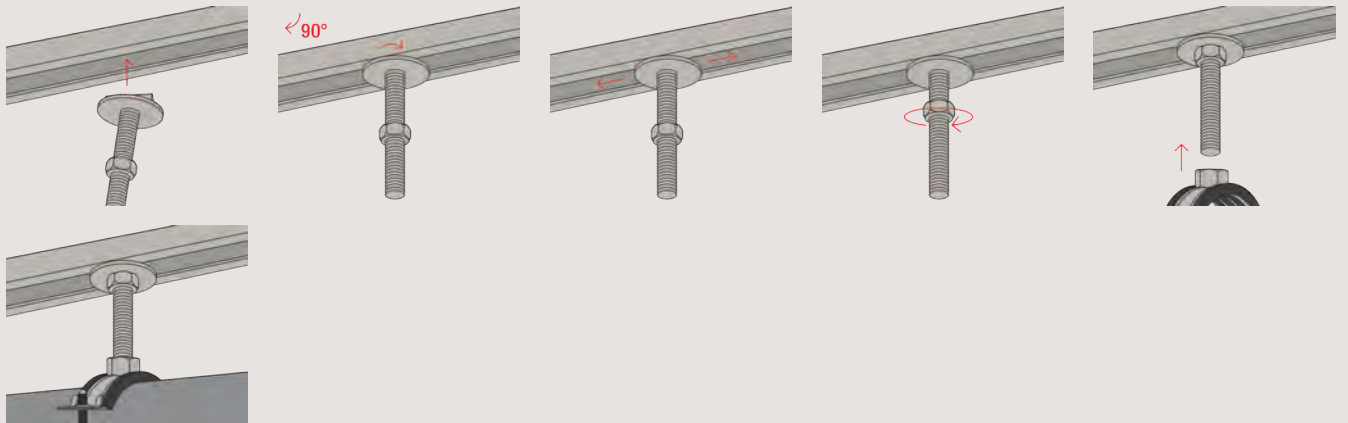

Technical data

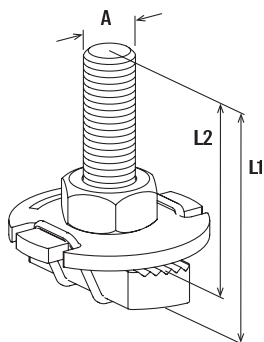

FCSN

Item	Item No.	Thread A	Length L_1 [mm]	Length L_2 [mm]	Sales unit [pcs]
FCSN M 8 x 30	092960	M 8	36	30	50
FCSN M 8 x 40	092961	M 8	46	40	50
FCSN M 8 x 50	093354	M 8	56	50	50
FCSN M 8 x 60	093355	M 8	66	60	50
FCSN M 10 x 30	093360	M 10	38	30	50
FCSN M 10 x 40	093361	M 10	48	40	50
FCSN M 10 x 50	093362	M 10	58	50	50
FCSN M 10 x 60	093363	M 10	68	60	50
FCSN M 12 x 30	093366	M 12	39	30	50
FCSN M 12 x 40	093367	M 12	49	40	50

Loads

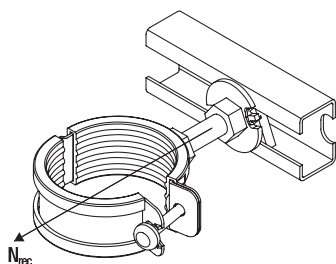

FCSN

Item	Item No.	Max. recommended tension load for FUS 2,0 mm	Max. recommended tension load for FUS 2,5 mm	Tightening torque
		N_{rec} [kN]	N_{rec} [kN]	T_{inst} [Nm]
FCSN M 8 x 30	092960	4.0	4.0	5
FCSN M 8 x 40	092961	4.0	4.0	5
FCSN M 8 x 50	093354	4.0	4.0	5
FCSN M 8 x 60	093355	4.0	4.0	5
FCSN M 10 x 30	093360	4.0	5.0	10
FCSN M 10 x 40	093361	4.0	5.0	10
FCSN M 10 x 50	093362	4.0	5.0	10
FCSN M 10 x 60	093363	4.0	5.0	10
FCSN M 12 x 30	093366	4.0	5.0	10
FCSN M 12 x 40	093367	4.0	5.0	10

Channel nut FCN

Connector - Channel nut FCN



Applications

- Simple hammer-head nut for installation in FUS channels
- The FCN is suitable for the connection of different fixtures and pipe clamps with the channel

Advantages/benefits

- The teeth on the sliding nut provide a secure hold in the FUS channel.

Properties

- Material: steel with min. tensile strength of 415 N/mm²
- Zinc plating: electro zinc-plated, min. 5 µm

Technical data

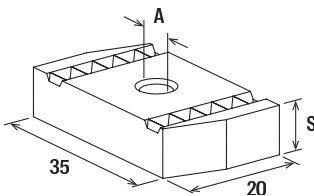

FCN

Item	Item No.	Thread A	Thickness S [mm]	Sales unit [pcs]
FCN 6	077405	M 6	6	100
FCN 8	077407	M 8	6	100
FCN 10	077409	M 10	8	100
FCN 12	077411	M 12	9	100

Loads

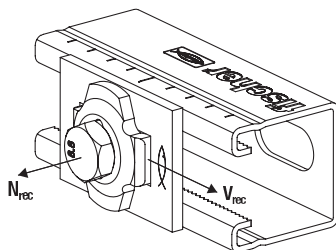

FCN

Item	Item No.	Max. recommended tension load for FUS 1,5 mm N_{rec} [kN]	Max. recommended tension load for FUS 2,0 mm N_{rec} [kN]	Max. recommended tension load for FUS 2,5 mm N_{rec} [kN]	Max. recommended shear load for FUS 1,5 mm V_{rec} [kN]	Max. recommended shear load for FUS 2,0/2,5 mm V_{rec} [kN]	Tightening torque for screw grade ≥ 8.8 T_{inst} [Nm]
FCN 6	077405	2.5	3.0	3.0	1.0	1.0	10
FCN 8	077407	3.0	4.0	4.0	1.5	2.0	20
FCN 10	077409	4.0	5.0	8.0	2.0	2.5	40
FCN 12	077411	4.0	5.0	8.0	2.0	2.5	50

Channel washer HK 41

Connector - Channel washer HK

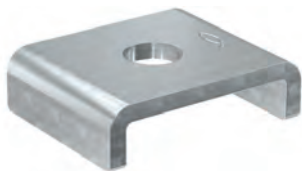

Lateral pipe mounting at channel



Channel installation at wall

Applications

- Channel washer to strengthen the profile

Certificates



Fire resistance classification
R120



MLAR R30

Advantages/benefits

- The U-shape of the channel washer prevents the profile from bending effectively.
- The shape of the channel washer makes the push-through installations of channel profiles quick and easy.

Properties

- Material: steel S235 JR (material no.: 1.0037) acc. to DIN EN 10025
- Zinc plating: electro zinc-plated, min. 5 µm

Technical data

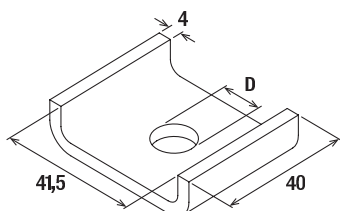

HK 41

Item	Item No.	Fire test report	Hole-Ø D [mm]	Sales unit [pcs]
HK 41 8,5	547492	—	8.5	50
HK 41 10,5	547493	X	10.5	50
HK 41 12,5	547494	X	12.5	50

Saddle flange SF

Construction element - Saddle flange SF



Pipe installation in escape route



Cantilever with saddle flange

2c

Applications

- For solid connections between the massive profile and building structures

Certificates



Fire resistance classification
R120



MLAR R30

Advantages/benefits

- The perfect-fit saddle of the SF enables a simple installation by inserting the channel.
- The saddle flange's stable design offers a secure hold for a load-bearing construction.

Properties

- Material base plate: steel DC01 (material no.1.0330) acc. to DIN EN 10139
- Zinc plating base plate: electro zinc-plated, min. 8 µm
- Material U-Profile: steel S235 JR (material no. 1.0037) nach DIN EN 10025
- Zinc plating U-Profile: electro zinc-plated, min. 8 µm

Technical data

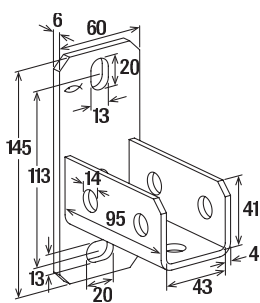

SF L 41

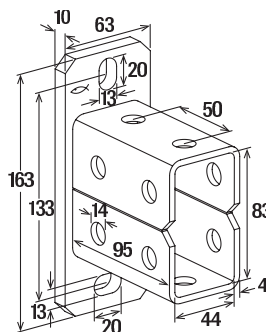

SF L 82

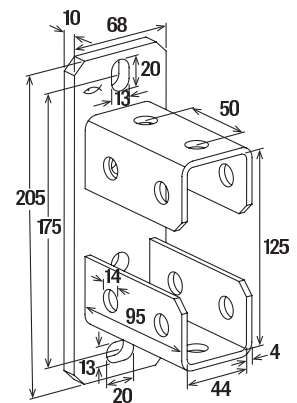

SF L 124

Item	Item No.	Fire test report	For profile	Sales unit [pcs]
SF L 41	504355	X	21, 41, 21D, 62	10
SF L 82	504357	—	41 D	5
SF L 124	504358	—	62 D	5

Mounting bracket UWS

Construction element - Universal bracket UWS

2c

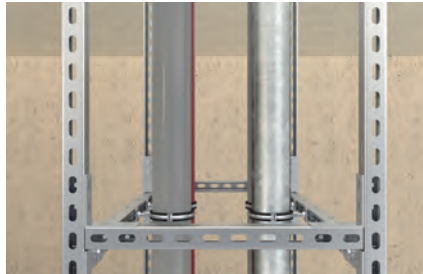

3D-frame constructions



Support systems for ventilation

Applications

- Universal angle bracket for the reinforcement of supporting structures

Certificates



Fire resistance classification
R120



MLAR R30

Advantages/benefits

- The universal bracket for the connection of fischer channels gives a supporting structure, great stability and safety (we recommend using in pairs).

Properties

- Material: steel S235 JR (material no.: 1.0037) acc. to DIN EN 10025
- Zinc plating: electro zinc-plated, min. 5 µm

Technical data

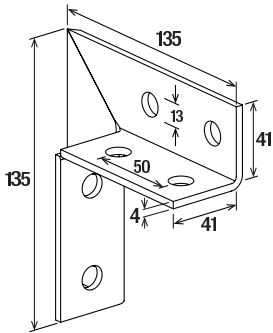

UWS

Item	Item No.	Fire test report	Sales unit
UWS	049479	X	[pcs] 10

Angle bracket WK

Construction element - Angle bracket WK



Heavy drainage pipe under angle bracket



Solid frame construction

2c

Applications

- Reinforcement and fixing of pipelines and pipe components

Advantages/benefits

- The design of the angle bracket allows for the fixing of pipe clamps or channels.
- The stable angle ensures a very high level of stability and safety to the structure.

Properties

- Material: steel DD11 (material no. 1.0332) acc. to DIN EN 10111
- Zinc plating: electro zinc-plated, min. 8 µm

Technical data

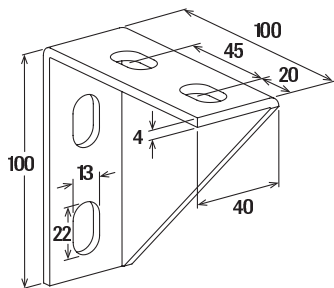

WK 100/100

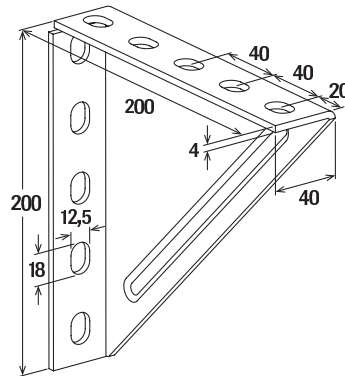

WK 200/200

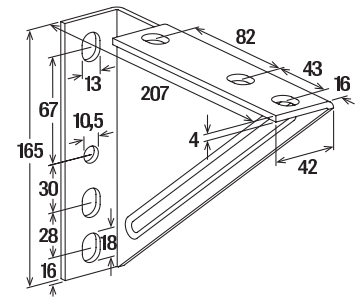

WK 207/165

Item	Item No.	Sales unit
		[pcs]
WK 100/100	063559	5
WK 200/200	079570	5
WK 207/165	079571	6

Loads

Item	Item No.	Max. recommended static load load case 1	Max. recommended static load load case 2
		F_{rec} [kN]	F_{rec} [kN]
WK 100/100	063559	—	4.0
WK 200/200	079570	4.0	1.8
WK 207/165	079571	—	1.8

Load case 1

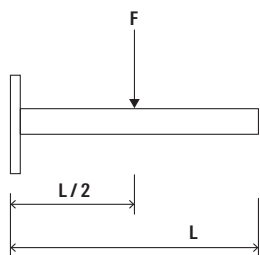

Load case 2

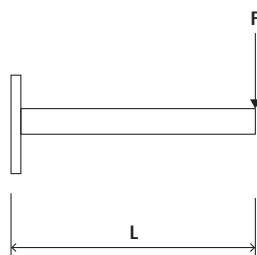

Bracket FFF

Construction elements - Brackets FFF

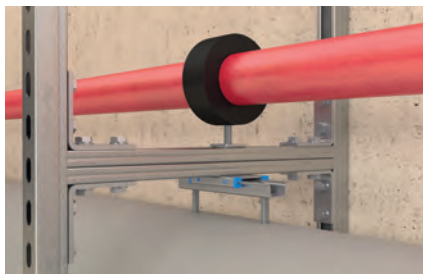
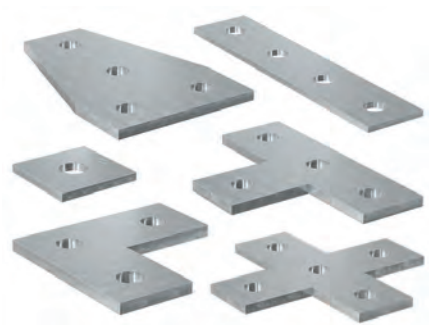

Frame constructions



Connection on channel

2c

Applications

- Connecting elements for the joining or strengthening of simple channel constructions

Properties

- Material: steel S235 JR (material no.10037) acc. to DIN EN 10025
- Zinc plating: electro zinc-plated, min. 5 µm

Technical data

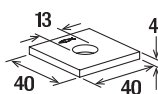

FFF 1

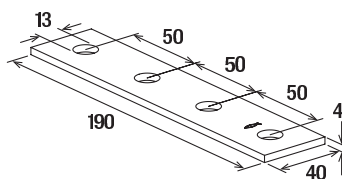

FFF 4

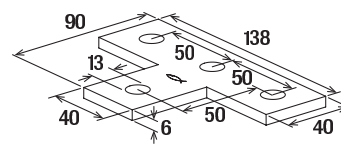

FFF 4T

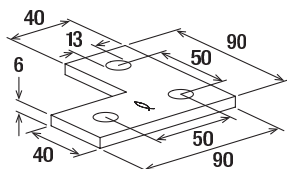

FFF 3L

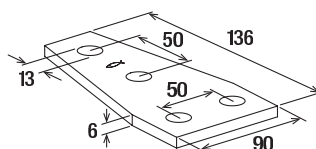

FFF 4D

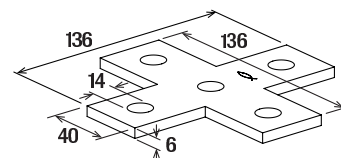

FFF 5C

Item	Item No.	Sales unit	
			[pcs]
FFF 1	547500		25
FFF 3L	504498		25
FFF 4	547501		25
FFF 4T	504500		25
FFF 4D	504368		25
FFF 5C	553073		20

Loads

See Channel nut FCN Clix P

Bracket FAF

Construction elements - Mounting bracket FAF

2c

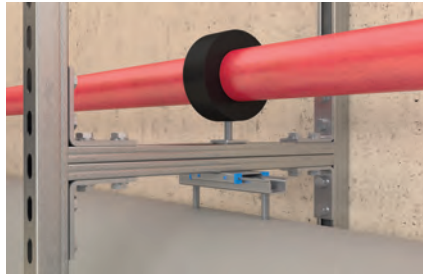

Frame constructions

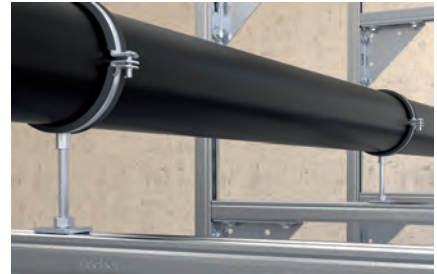

Connection on channel

Applications

- Connecting elements for the joining or strengthening of simple channel constructions

Properties

- Material: steel S235 JR (material no.10037) acc. to DIN EN 10025
- Zinc plating: electro zinc-plated, min. 5 µm

Technical data

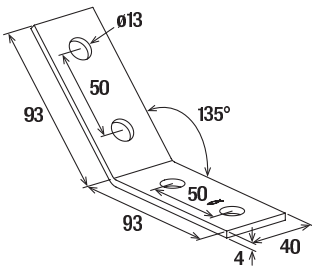

FAF 4/135°

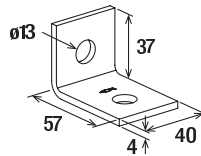

FAF 2

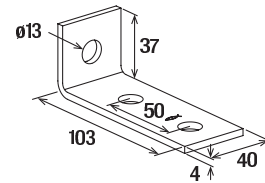

FAF 3

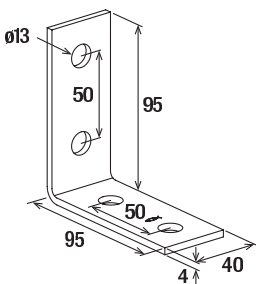

FAF 4

Item	Item No.	Sales unit
		[pcs]
FAF 4/135°	547505	25
FAF 2	547502	25
FAF 3	547503	25
FAF 4	547504	25

Loads

See Channel nut FCN Clix P

Flanges FZF

Construction elements - Mounting brackets FZF, FUF

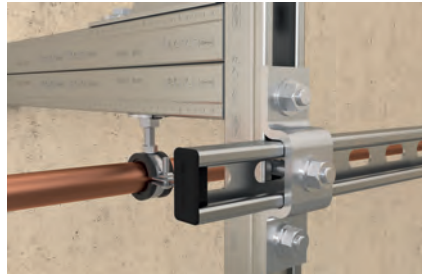

Cross connection on channel

Applications

- Connecting elements for multi-dimensional channel constructions

Properties

- Material: steel S235 JR (material no.10037) acc. to DIN EN 10025
- Zinc plating: electro zinc-plated, min. 5 µm

Technical data

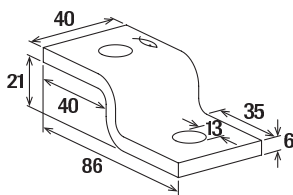

FZF 21

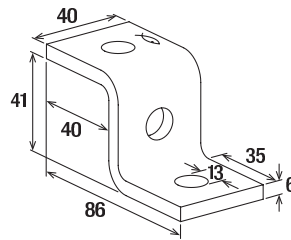

FZF 41

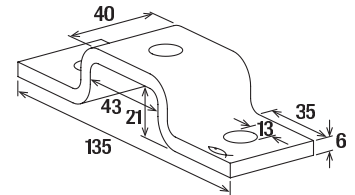

FUF 21

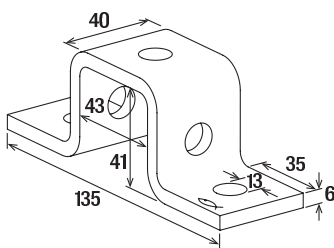

FUF 41

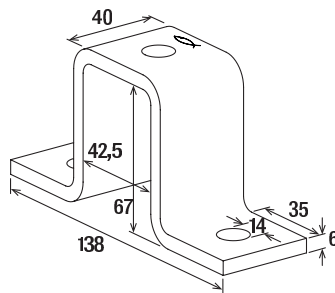

FUF 62

Item	Item No.	Sales unit
		[pcs]
FZF 21	504375	25
FZF 41	504515	25
FUF 21	504376	25
FUF 41	504377	25
FUF 62	553076	15

Loads

See Channel nut FCN Clix P

Flanges FUF

Construction elements - Mounting brackets FUF

2c

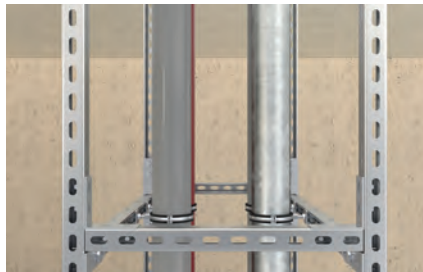
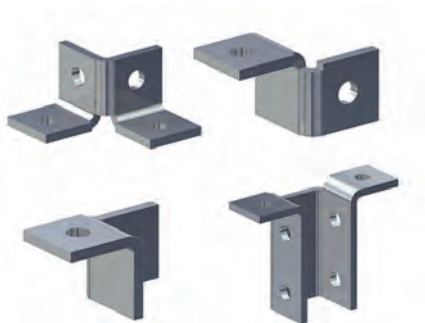

3D-frame constructions

Applications

- Connecting elements for multi-dimensional channel constructions

Advantages/benefits

- The various shapes of the connecting elements offer flexibility during the installation of channel constructions.
- The holes in the connecting elements make them compatible with the FCN Clix P.

Properties

- Material: steel S235 JR (material no.10037) acc. to DIN EN 10025
- Zinc plating: electro zinc-plated, min. 5 µm

Technical data

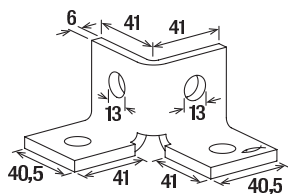

FUF 4Y

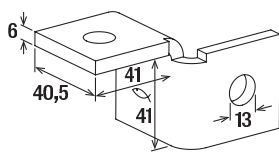

FUF 180°L

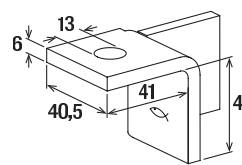

FUF 180°R

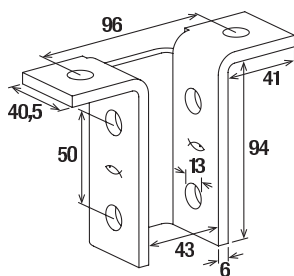

FUF 8T

Item	Item No.	Sales unit
		[pcs]
FUF 4Y	504378	20
FUF 180°L	504379	20
FUF 180°R	504383	20
FUF 8T	504387	10

Loads

See Channel nut FCN Clix P

Variable bracket VB

Construction element - Variable bracket VB



Massive bracing of cantilever arm

2c

Applications

- Variable bracket for FUS channel profiles to built up supporting structures
- Bracket for installation with FUS channels from 0° to 180°

Advantages/Benefits

- The design of the variable bracket VB enables the fixation of mounting channels at an angle of 0° to 180°.
- Due to the holes on all three sides, the channels can be installed with the slot lateral.
- The punched holes in the base plate allow the direct fixing to the substructure or onto a mounting channel.

Properties

- Material: steel S235 JR (material no.: 1.0037) acc. to DIN EN 10025
- Zinc plating: electro zinc-plated, min. 5 µm

Technical data

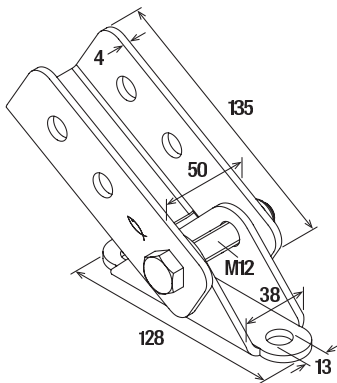

VB

Item	Item No.	Sales unit
		[pcs]
VB	545650	5

Loads

See Channel nut FCN Clix P

Universal mounting UHRS

Construction element - Universal mounting UHRS

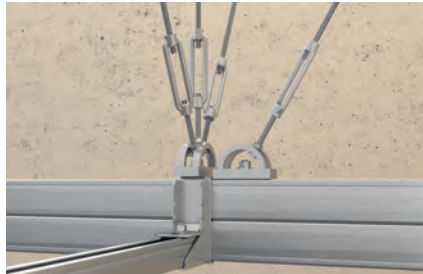
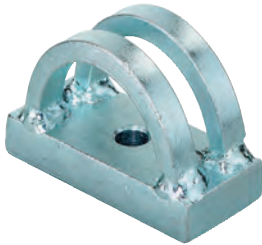

Channel bracing for installation grid

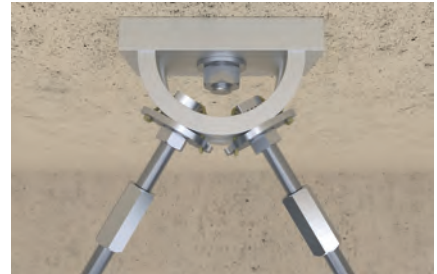

Bracings with UHRS

2c

Applications

- Variable anchor bracket for anchoring with threaded rods
- Can be used together with FHS Clix S M 12

Advantages/benefits

- The design of the universal mount allows the anchoring by using threaded rods at all angles.
- The hole in the base plate enables the direct fixing onto a wall or ceiling, or onto a channels.

Properties

- Material: steel S235 JRG (material no. 1.0038) acc. to DIN EN 10025
- Zinc plating: electro zinc-plated, min. 3 µm

Technical data

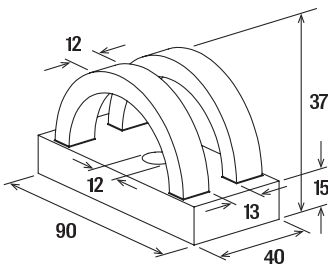

UHRS

Item	Item No.	Sales unit
		[pcs]
UHRS	063938	6

Loads

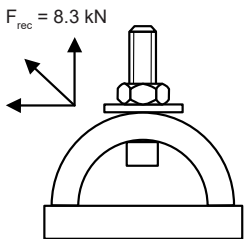

Universal hinge FUH

Construction element - Universal hinge FUH

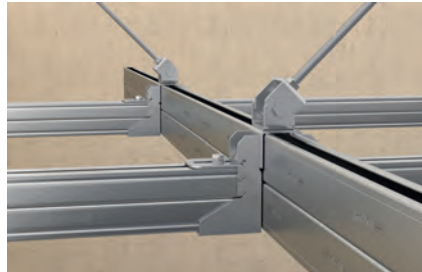

Inclined bracing for installation grid

Applications

- Variable construction element for bracing with threaded rods or to fix pipelines to sloped substructures.
- Can be attached directly to the underground or to FUS channels.
- Flexible use especially for sloped substructures or undergrounds.

Advantages/Benefits

- Flexible solution for many applications such as fixing of pipelines to sloped undergrounds or bracing with threaded rods.
- Free adjustable angle up to 90°.
- Easy to use.

Properties

- Material: steel S235 JR (material no.: 1.0037)
- Zinc plating: electro zinc-plated, min. 5 µm

Technical data

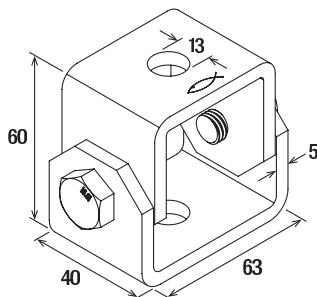

FUH

Item	Item No.	Sales unit
		[pcs]
FUH 13	543065	6

Loads

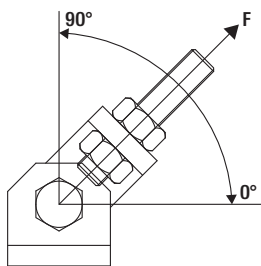

2c

Angle	90°	75°	60°	45°	30°	0°
Maximum recommendet load [kN]	6	5,5	5	4	3	2,5

Intermediate values can be interpolated.

Threaded rod bracket FSB 45°

Construction element - Threaded rod bracket FSB 45°



Heavy pipe on cantilever



Cantilever with saddle flange

2c

Applications

- 45°-element for bracing with M10 threaded rods

Advantages/benefits

- The anchoring element's socket allows the fast insertion of a pre-mounted M10 threaded rod with nut.
- The hole in the base plate enables the direct fixing onto a wall or ceiling or onto a channel.

Properties

- Material: steel DD11 (material no. 1.0332) acc. to DIN EN 10111
- Zinc plating: electro zinc-plated, min. 5 µm

Technical data

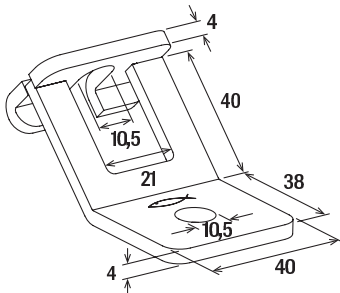

FSB 45°

Item	Item No.	Sales unit
		[pcs]
FSB 45°	071269	20

Loads

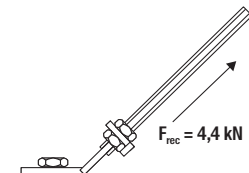

Beam clamp TKR

Clamp for fixing of profiles to steel girders



Channel to steelbeam

Applications

- Fixing to steel girders requires two clamps per connection

Advantages/benefits

- The design of the beam clamp allows fixing without drilling or welding.
- The various lengths of the beam clamp enable the fixing on most standard beams.
- The shape of the beam clamp allows the simple adjustment of the channel connection.

Properties

- Material plate/U-bolt pipe hanger: steel S235 JR (material no.10037) acc. to DIN EN 10025
- Material hexagon nut: steel resistance class 8
- Zinc plating: electro zinc-plated, min. 5 µm

Technical data

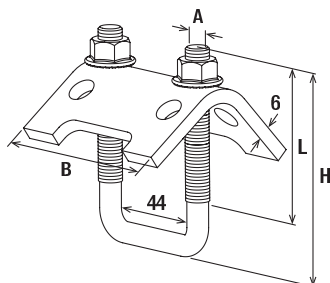

TKR

Item	Item No.	For profile	Thread A	Width B [mm]	Height H [mm]	Length L [mm]	Sales unit [pcs]
TKR 21 - 42	504363	21/41	M 8	79	97	50	20
TKR 82	504366	62, 41D	M 10	79	137	80	20
TKR 124	504367	62 D	M 10	79	179	80	10

Loads

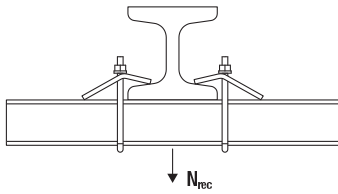

TKR

Item	Item No.	Max. recom. static load (centr. tension) $N_{\text{recom.}}$ [kN]	Tightening torque T_{inst} [Nm]	Max. clamping range on girders [mm]
TKR 21 - 42	504363	5.00	15	30
TKR 82	504366	10.0	20	30
TKR 124	504367	10.0	20	30

2c

2d

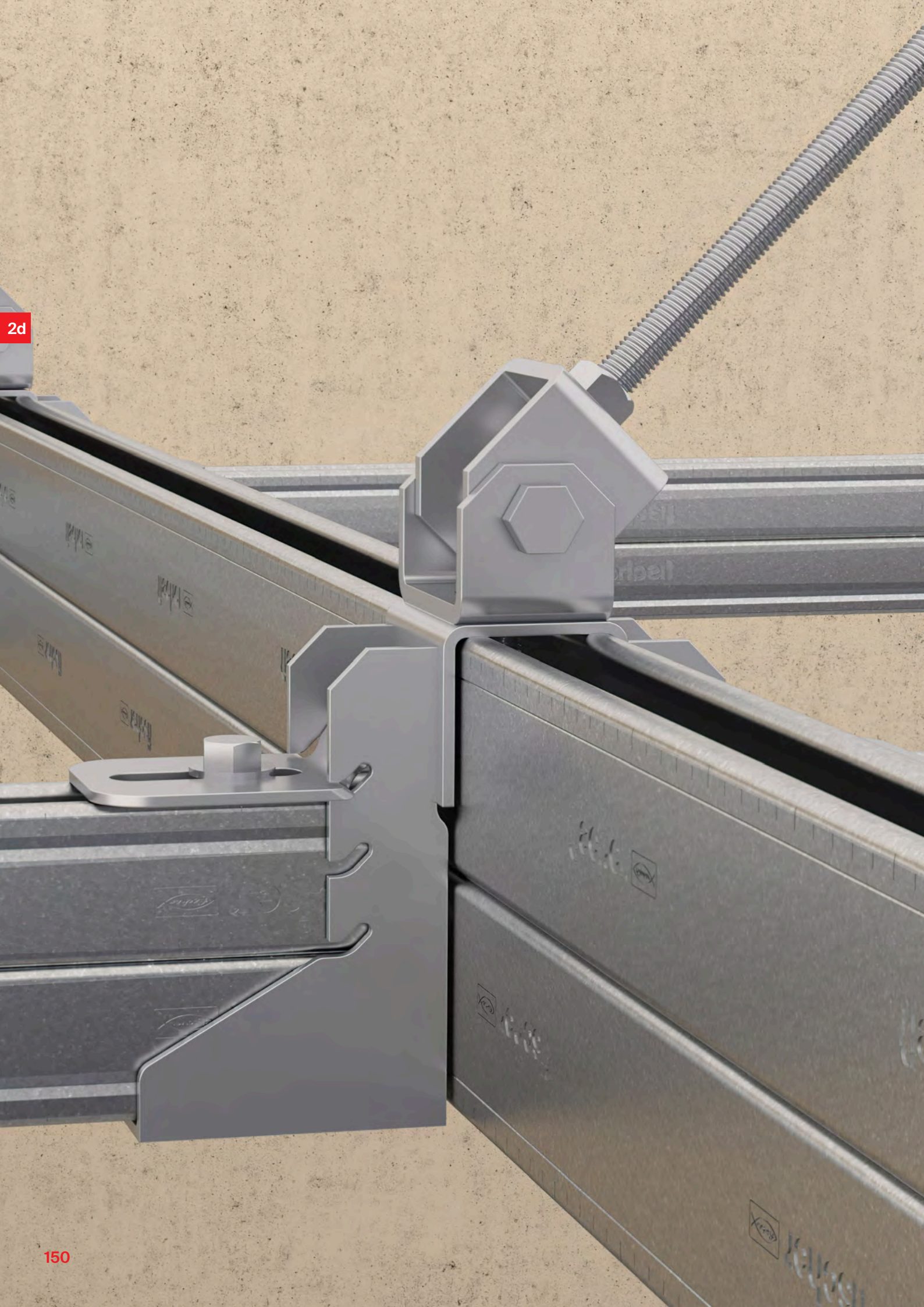

2d

Installation grid

CHANNELS

Channel FUS

155



CONNECTORS

Cross connector FVS II

154



Connector FCN Clix P

159



Universal hinge FUH

159



Hexagonal connector VM

158



Turnbuckle SPS,
Bolt left-hand/right-hand BLR

158



CONSTRUCTION ELEMENTS

Channel connector FUF OC

156



Beam clamp TKR

158



ACCESSORIES

Channel washer HK 41

156



Threaded rod G

156

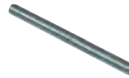

Hexagonal nut MU

157



Washer U

157



Hexagonal screw SKS

157



Channel nut FCN

160



Cover cap FEC

159



2d



Installation grid.

Fit for today's and tomorrow's demands

Planning for the future means constantly being prepared to meet new requirements. That is why the fischer Installation Grid is the installation system for modern and future supply technology in industrial buildings. Its strengths are:

- quick installation and consequent low costs
- high flexibility and adaptability to change utilization of buildings
- good order and organization in media supply

- new design perspectives
- clear calculation of time and cost thanks to modular construction
- highly economical over the entire duration of utilization
- support in planning and installation provided by fischer engineers

Backed up by the entire know-how and experience of a leading manufacturer of fixing systems.

Effective installation with the fischer Installation Grid

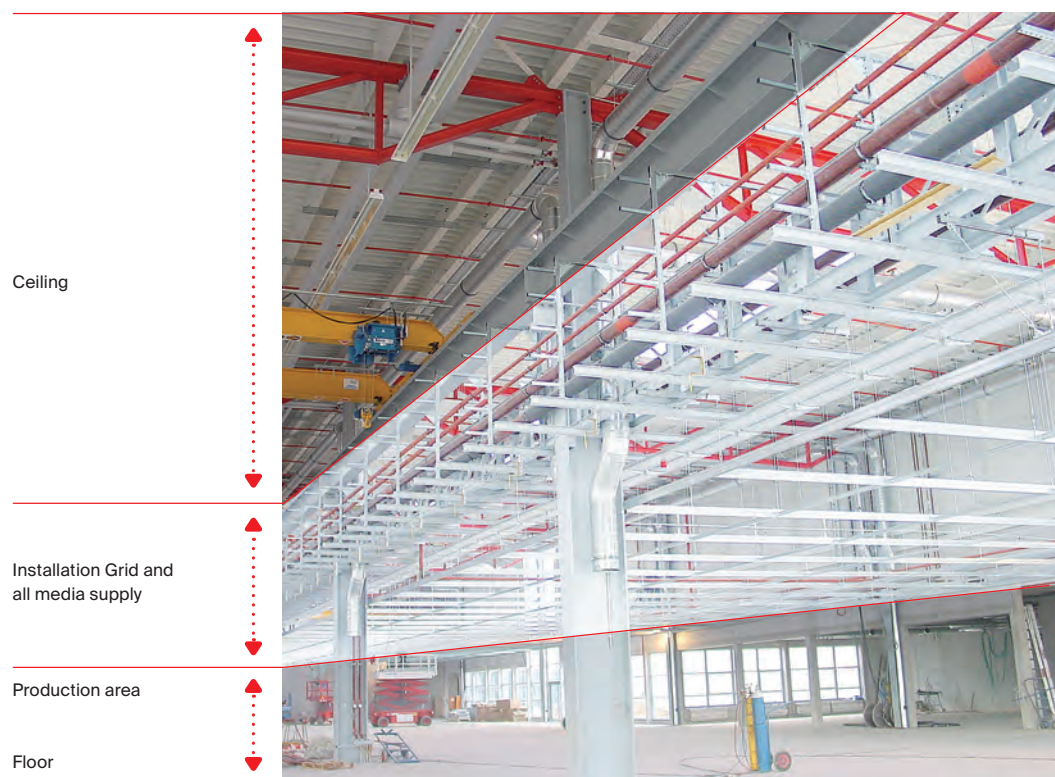

A separate level for the installation of media-supply equipment is constructed under the ceiling using a system of rails and special fixing elements from the fischer Installation

Systems program. This Installation Grid can be specially adapted for any building.

Cross connector FVS II

Cross connector to create an flexible installation grid

2d



Supply lines on installation grid

Applications

- Cross connectors for installation of an installation grid by utilization of FUS channels
- Ceiling suspension with the use of threaded rods
- FUS channel lengthwise: FUS 62D
- FUS channel crosswise: FUS 41, FUS 21D, FUS 62, FUS 41D

Advantages/Benefits

- The design of the cross connector allows for the simple and time-saving creation of an installation grid.
- The cross connector over the vertical channel allows the installation to be carried out by one person.
- The design of the FVS 3 II are also ideal to create traverse installations.

Properties

- Material: steel S235 JR (material no.: 1.0037) acc. to DIN EN 10025
- Zinc plating: electro zinc-plated, min. 5 µm

Technical data

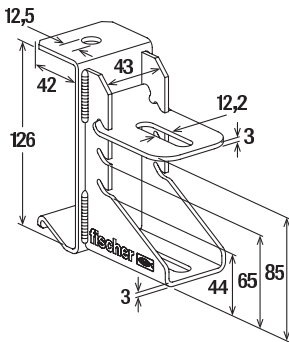

FVS 3 II

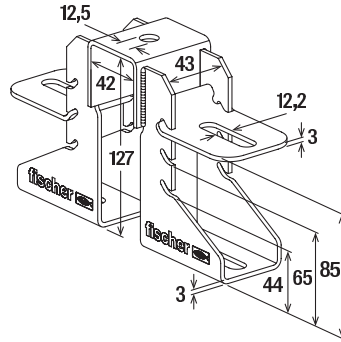

FVS 4 II

Item	Item No.	For profile	Sales unit
			[pcs]
FVS 3 II	543060	FUS channel crosswise: FUS 41, FUS 21D, FUS 62, FUS 41D - FUS channel lengthwise: FUS 62D	8
FVS 4 II	543063	FUS channel crosswise: FUS 41, FUS 21D, FUS 62, FUS 41D - FUS channel lengthwise: FUS 62D	5

Installation

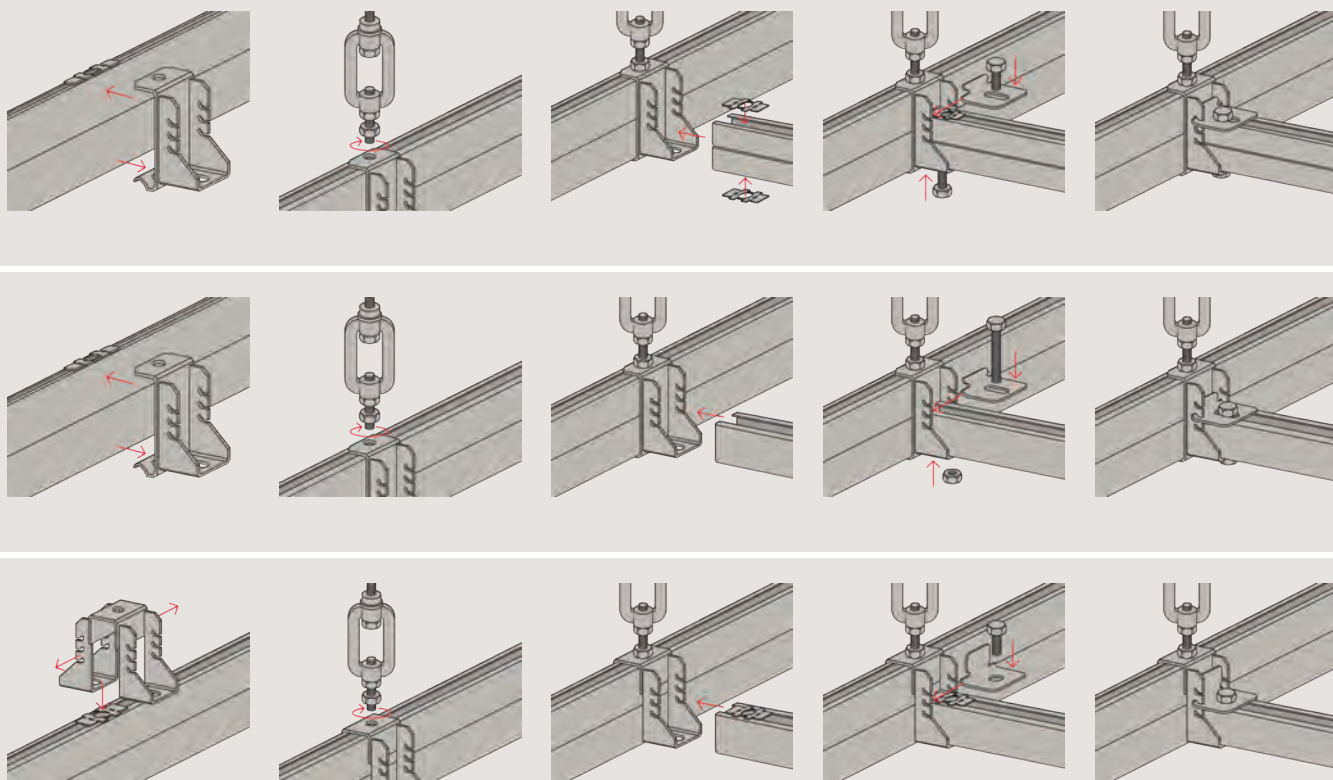

Channel FUS



FUS



FUS D

Item	Item No.	Length L [mm]	Profile thickness [mm]	Weight [kg/m]	Sales unit [pcs]
FUS 41/2,0 - 3 m	097658	3000	2	2.06	1
FUS 41/2,0 - 6 m	097659	6000	2	2.06	1
FUS 41/2,5 - 3 m	077347	3000	2,5	2.45	1
FUS 41/2,5 - 6 m	077537	6000	2,5	2.45	1
FUS 62/2,5 - 6 m	504457	6000	2,5	3.27	1
FUS 21D/2,0 - 3 m	504458	3000	2	2.87	1
FUS 21D/2,0 - 6 m	535531	6000	2	2.87	1
FUS 41D/2,5 - 6 m	504459	6000	2,5	4.89	1
FUS 62D/2,5 - 6 m	504460	6000	2,5	6.55	1

Characteristics

See page 96

Channel connector FUF OC



FUF OC 62

Item	Item No.	Length L [mm]	Thickness S [mm]	Sales unit [pcs]
FUF OC 62	504518	400	4	10

Characteristics

See page 102

Channel washer HK 41

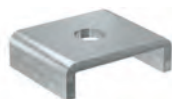

HK 41

Item	Item No.	Sales unit [pcs]
HK 41 12,5	547494	50

Characteristics

See page 133

Threaded rod G



G

Item	Item No.	Length L [mm]	Thread A	Sales unit [pcs]
G 12/3	064056	3000	M 12	5

Characteristics

See page 198

Hexagonal nut MU



MU

Item	Item No.	Thread A	Width across nut SW [mm]	Sales unit [pcs]
MU M 12	024650	M 12	19	100

Characteristics

See page 209

Washer U



U

Item	Item No.	Thickness S [mm]	Hole-Ø D [mm]	Sales unit [pcs]
U 12 x 40	024649	3	12.5	100

Characteristics

See page 208

Hexagonal bolt SKS



SKS

Item	Item No.	Length L [mm]	Thread A	Width across nut SW [mm]	Sales unit [pcs]
SKS 12 x 25	535538	25	M 12	19	100
SKS 12 x 65	535539	65	M 12	19	50
SKS 12 x 85	505553	85	M 12	19	100

Characteristics

See page 208

Hexagonal connector VM



VM

Item	Item No.	Thread A	Sales unit [pcs]
VM M 12	020971	M 12	100

Characteristics

See page 209

Turnbuckle SPS / BLR



SPS

BLR

Item	Item No.	Thread A	Sales unit [pcs]
SPS M 12	064090	M 12	25
BLR 100 M12	064091	M 12	25

Characteristics

See page 207

Beam clamp TKR



TKR

Item	Item No.	For profile	Sales unit [pcs]
TKR 124	504367	62 D	10

Characteristics

See page 207

Universal bracket FUH



FUH

Item	Item No.	Sales unit	
		[pcs]	
FUH 13	543065	6	

2d

Characteristics

See page 139

Cover cap FEC



FEC 21 B

Item	Item No.	Material	Sales unit	
			[pcs]	
FEC 21 B	077357	Polyethylene, black	100	
FEC 41 B	077355	Polyethylene, black	100	
FEC 62 B	505551	Polyethylene, black	100	

Characteristics

See page 110

Channel nut FCN Clix P



FCN Clix P

Item	Item No.	Thread A	Sales unit	
			[pcs]	
FCN Clix P 12	504331	M 12	100	

Characteristics

See page 125

Channel nut FCN

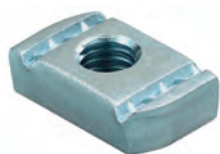

FCN

Item	Item No.	Thread A	Sales unit [pcs]
FCN 12	077411	M 12	100

2d

Characteristics

See page 131

2e

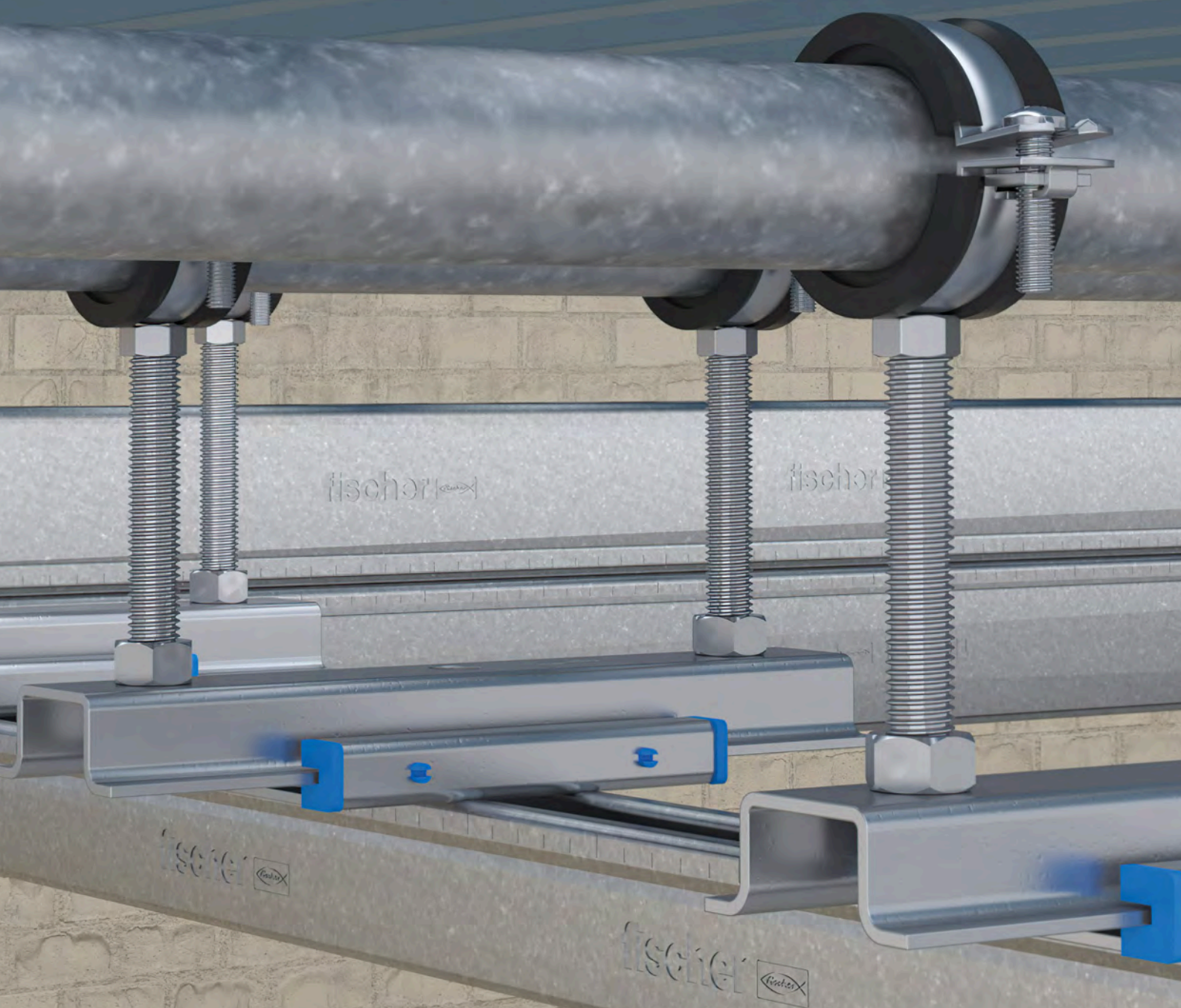

2e

Fixpoint and sliding elements

Fixpoint clamp FFPS and -saddle FFPK	164	
Sound insulated fix point FSFP	166	
Sliding element GL	167	
Sliding saddle SBS	168	
Sliding element FSC1	169	
Sliding hanger SB	170	
Pendulum hanger PDH / PDH K	171	

Fixpoint clamp FFPS and -saddle FFPK

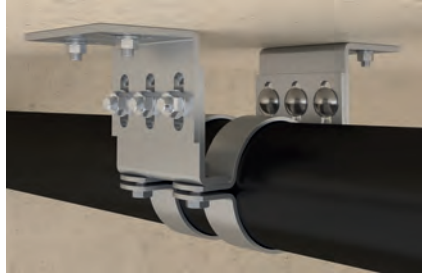
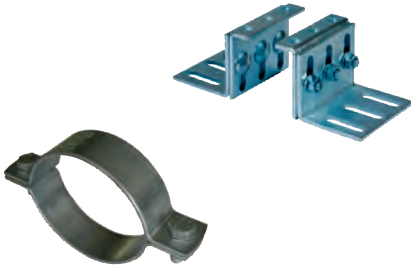

Fixpoint-pipecollar

2e

Applications

- Prevention of unwanted displacement between the pipes and the structures
- Ensuring of the expansion into the desired direction

Advantages/benefits

- The system's modular design allows it to be adjusted to the required loads.
- The system's high load level enables increased fixing distances.
- The fixpoint saddle allows a height and angle adjustment.
- The special washers on the clamp and console ensure a quick installation.

Properties

- FFPS: S185-Z-150 NA-NK (material no. 1.0035) acc. to DIN EN 10035
- FFPK: S235 JR (material no. 1.0037) acc. to DIN EN 10025
- Zinc plating: electro zinc-plated, min. 5 µm

Technical data

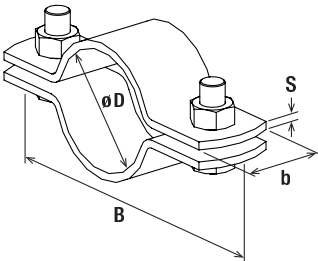

FFPS

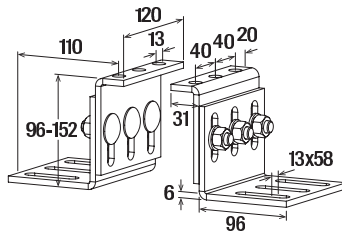

FFPK

Item	Item No.	Size	Clamping range	Width	Locking screw	Width x thickness clamp band b x s [mm]	Tightening torque T _{inst} [Nm]	Sales unit [pcs]
		[inch]	D [mm]	B [mm]				
FFPS 2"	048510	2"	56 - 61	137	M 12	40 x 4,0	60	1
FFPS 2 1/2"	048511	2 1/2"	75 - 80	156	M 12	40 x 4,0	60	1
FFPS 3"	048512	3"	88 - 93	170	M 12	40 x 4,0	60	1
FFPS 4"	048513	4"	108 - 115	191	M 12	40 x 4,0	60	1
FFPS 5"	048660	5"	133 - 140	217	M 12	40 x 4,0	60	1
FFPS 159 - 166	048662	159 - 166	159 - 166	243	M 12	40 x 4,0	60	1
FFPS 6"	048663	6"	167 - 172	250	M 12	40 x 4,0	60	1
FFPS 8"	048664	8"	219 - 225	303	M 12	40 x 4,0	60	1
FFPS 10"	048665	10"	267 - 274	351	M 12	40 x 4,0	60	1
FFPK	048666	—	—	—	—	—	—	1

Loads

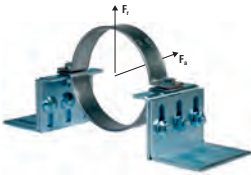

Fixpoint 1 clamp
 Max. recom. load
 axial $F_a = 5500$ N
 radial $F_r = 4660$ N

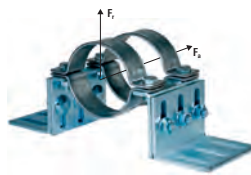

Fixpoint 2 clamps
 Max. recom. load
 axial $F_a = 11000$ N
 radial $F_r = 9320$ N

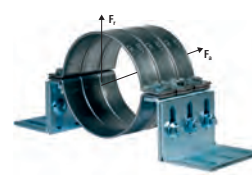

Fixpoint 3 clamps
 Max. recom. load
 axial $F_a = 16500$ N
 radial $F_r = 13980$ N

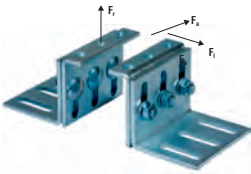

FFPK
 Saddle max. recom. loads
 radial $F_r = 42000$ N
 lateral $F_l = 17500$ N

Sound insulated fix point FSFP

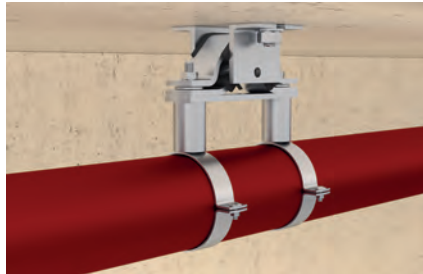

Sound insulated fixpoint at ceiling

2e

Applications

- Prevention of unwanted displacement between the pipes and the structures
- Ensuring of the expansion into the desired direction

Advantages/benefits

- The fixpoint's ageing-resistant insulation element is heat resistant and isolates the structure from sound transfer.
- The fully pre-mounted FSFP fixpoint ensures a quick and easy installation.
- The compact design of the fixpoint leads to high pipe loads in all fitting positions.

Properties

- Clamp strap: ST W22 (m+L34aterial no. 1.0032)
- Base plate: S235 JR (material no. 1.0038)
- Zinc plating: electro zinc-plated, min. 5 µm
- Elastomer: ISO 1629 SBR/EPDM chlorine-free and silicone-free
- Temperature range: -40 °C to +100 °C

Technical data / Loads

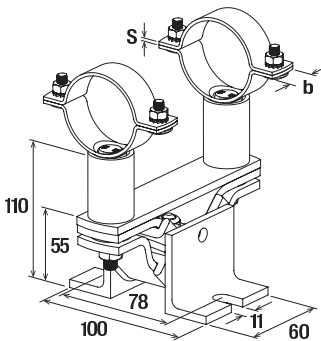

FSFP

Item	Item No.	Size	Clamping range	Locking screw	Width x thickness clamp band b x s [mm]	max. recommended load F _{rec} [kN]	Sales unit [pcs]
		[inch]	D [mm]				
FSFP 1"	512716	1"	33,7	M 6	20 x 1,5	4.0	1
FSFP 1 1/4"	512717	1 1/4"	42,4	M 6	20 x 2,0	4.0	1
FSFP 1 1/2"	512718	1 1/2"	48,3	M 6	20 x 2,0	4.0	1
FSFP 2"	512719	2"	60,3	M 8	30 x 2,5	4.0	1
FSFP 2 1/2"	512720	2 1/2"	76,1	M 8	30 x 2,5	4.0	1
FSFP 3"	512721	3"	88,9	M 8	30 x 2,5	4.0	1
FSFP 4"	512722	4"	114,3	M 8	30 x 2,5	4.0	1

Sliding element GL

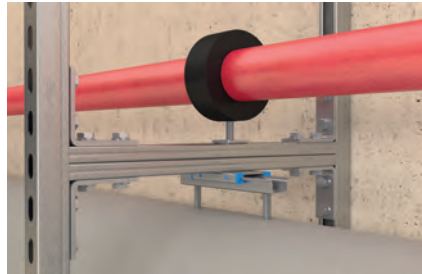

Frame constructions

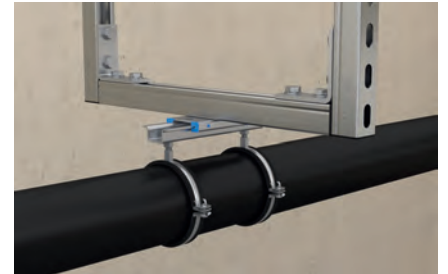

Pipe elongation with sliding element and suspended pipe

2e

Applications

- Sliding element with a maximum sliding distance of 160 mm for the absorption of axial length adjustments and expansion to pipelines

Advantages/benefits

- The low height of the sliding element allows a space-saving installation.
- The large sliding distance of the sliding element enables large expansion distances.
- The twin pipe support prevents pipes from moving in the wrong direction.

Properties

- Material: steel S235 JR (material no.: 1.0037) acc. to DIN EN 10025
- Zinc plating: electro zinc-plated, min. 8 µm
- Material sliding strips: Nylon 6
- Adhesion friction factor: 0,27 - 0,3
- Sliding friction factor: 0,15 - 0,25
- Thermal load capacity: -30 °C to +110 °C

Technical data / Loads

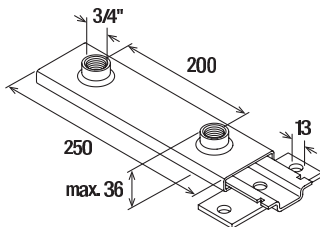

GLL 3/4"

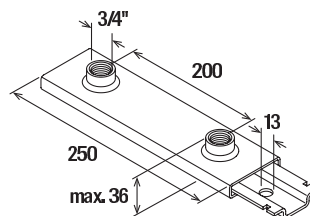

GL 3/4"

Item	Item No.	Max. recom. load values, suspended	Max. recom. load values, vertical	Max. recom. pipe-Ø	Sales unit
		[kN]	[kN]		[pcs]
GLL 3/4"	064038	3,50	4,00	200	5
GL 3/4"	064041	3,50	4,00	200	5

Sliding saddle SBS



Sliding element on cantilever

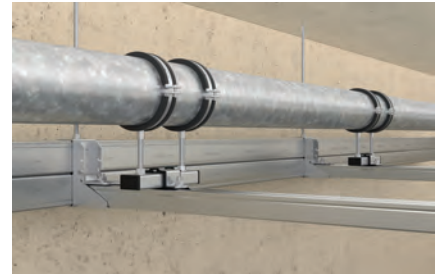

Screwed fixing of insulation boards

Applications

- Absorption of pipe expansions on two points
- Sliding distance for SBS 55 mm (M 10) and 60 mm (M 8), SBS 12/16 125 mm

Certificates



Fire resistance classification
R120



MLAR R30

Advantages/benefits

- The two point pipe support prevents pipes from slipping of the duct.
- The low height of the sliding saddle allows a space-saving installation.

Properties

- Material: steel DD11 (material no. 1.0332) acc. to DIN EN 10111 / PA GF 20
- Zinc plating: electro zinc-plated, min. 5 µm
- Adhesion friction factor: 0,25 - 0,30
- Sliding friction factor: 0,16 - 0,18
- Temperature range: -40 °C to +100 °C

Technical data / Loads

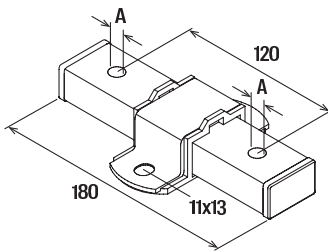

SBS

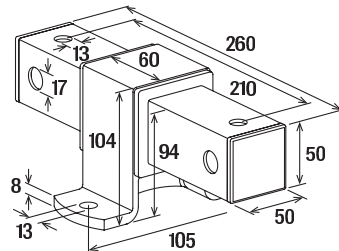

SBS 12/16

Item	Item No.	Fire test report	Thread A	Max. recom. load values, suspended [kN]	Max. recom. load values, vertical [kN]	Sales unit [pcs]
SBS M 8	079685	—	M 8	1,50	1,50	8
SBS M 10	079686	X	M 10	1,50	1,50	8
SBS 12/16	047726	X	M 12 / M 16	7,8	7,8	1

Sliding element FSC1

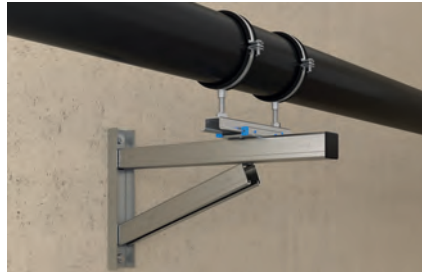

Sliding element on traverse made with FVS 3 II

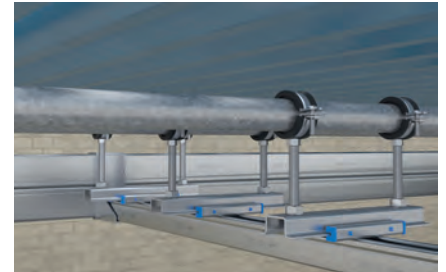

Sliding element on installation grid

2e

Applications

- Sliding element with a maximum sliding distance of 100 mm for the large axial expansion of pipelines

Advantages/benefits

- The holes in the sliding saddle allow the use as a single or double sliding element.
- The special design of the base plate prevents a sliding out.

Properties

- Material: steel DD11 (material no. 1.0332) acc. to DIN EN 10111
- Zinc plating: electro zinc-plated, min. 5 µm
- Temperature range: -30 °C to +120 °C

Technical data / Loads

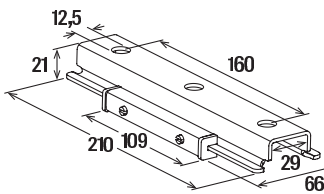

FSC 1

Item	Item No.	Connecting thread (holes)	Max. recommended static load (suspended) N _{rec} [kN]	Max. recommended static load (upright) N _{rec} [kN]	Sales unit [pcs]
FSC 1	507866	ø 12.5	1.3	1.0	12

Sliding hanger SB

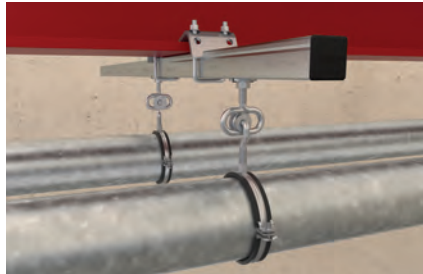

Channel with sliding element



Channel to steelbeam

Applications

- Adjustments of axial length to pipelines
- Installation of sliding elements in line with the expected length expansions (Ensuring that no sliding distance is lost and sliding isn't inhibited)

Advantages/benefits

- The design of the sliding hanger allows pipes to be mounted securely and easily.
- The sliding hanger is ideally suited to adjust the axial length of pipelines.

Properties

- Material: steel DD11 (material no. 1.0332) acc. to DIN EN 10111
- Zinc plating: electro zinc-plated, min. 3 µm

Certificates



Fire resistance classification
R120



MLAR R30

Technical data / Loads

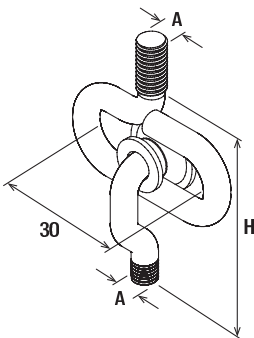

PDH

Item	Item No.	Fire test report	Thread	Height	Max. recom. statc load (centr. tension) [kN]	Sales unit [pcs]
			A	H [mm]		
SB M 8	079680	—	M 8	75	0.40	25
SB M 10	079681	X	M 10	90	0.65	25

Pendulum hanger PDH / PDH K



Double pendulum hanger

2e

Applications

- Single fixing for the absorption of pipe-line length adjustments in any direction
- Installation of the pendulum in pairs for pipe movement without tipping
- Secure threaded rod with lock nut to prevent loosening

Certificates



Fire resistance classification
R120



MLAR R30

Advantages/benefits

- The design of the pendulum hanger allows a rotation of 360°.
- The pendulum hanger's screw-in sleeve allows for large height adjustments.
- The max. pendulum angle of 12° enables the absorption of large expansions.
- The screw-in depth of the threaded bolts guarantees a high tension load.

Properties

- Material: steel DD11 (material no. 1.0332) acc. to DIN EN 10111
- Zinc plating: electro zinc-plated, min. 5 µm

Technical data / Loads

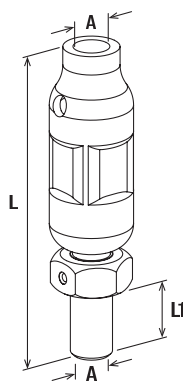

PDH

Item	Item No.	Fire test report	Thread	Length	Length	Max. recom. statc load (centr. tension) [kN]	Sales unit [pcs]
			A	L [mm]	L ₁ [mm]		
PDH K M 8	068267	—	M 8	50	18	2.4	50
PDH K M 10	068269	X	M 10	54	18	3.0	50
PDH M 8	079676	—	M 8	76	18	2.4	50
PDH M 10	079677	X	M 10	80	18	3.0	50
PDH M 12	064037	X	M 12	90	20	3.5	25

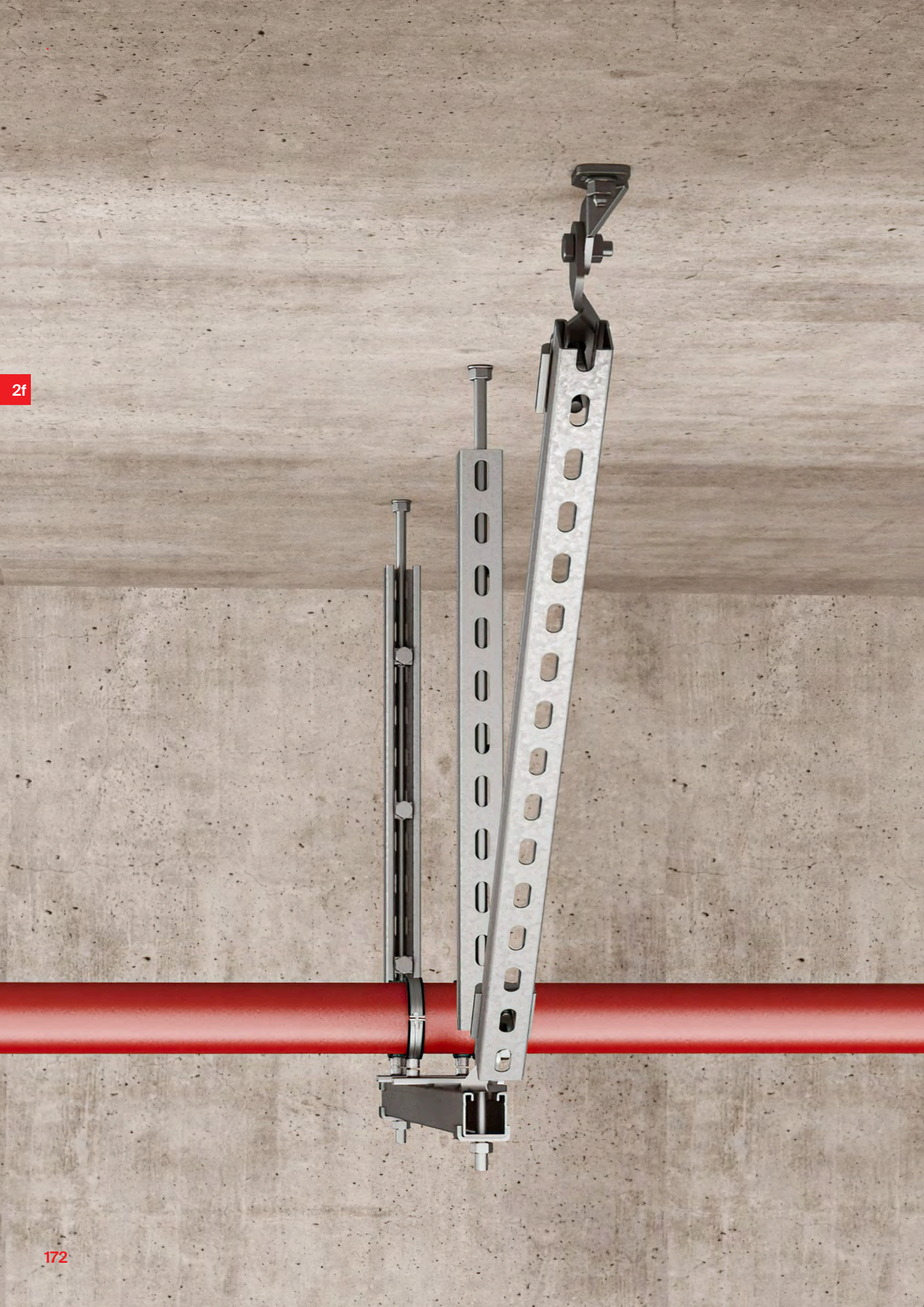

2f

2f

Seismic bracing assortment

PIPE CLAMPS

Seismic pipe clamp FSSC	174	
-------------------------	-----	---

CHANNEL BRACING ELEMENTS

Channel clamp FUSF	175	
--------------------	-----	---

Sway brace bracket FSF	176	
------------------------	-----	---

Shaped reinforcement strut SAE	177	
--------------------------------	-----	--

Threaded rod brace connector S-VA	178	
-----------------------------------	-----	---

Channel brace connector S-VB	179	
------------------------------	-----	---

90° angle connector S-FAF	180	
---------------------------	-----	---

ACCESSORIES

Threaded rod connector S-ROD	181	
------------------------------	-----	---

Rod stiffener FTRC M12 gvz	182	
----------------------------	-----	---

Torque bolt SKS M12x30	183	
------------------------	-----	---

Seismic pipe clamp FSSC

Seismic pipe clamp with FM approval for fixing and bracing of pipes



Pipe installation with seismic pipe clamp

2f

Applications

- For the secure fixation and bracing of pipeline systems

Certificates



Advantages/Benefits

- Both lateral and longitudinal forces are optimally absorbed for a secure and reliable installation.
- The FM approval of the FSSC guarantees objectively tested functional safety.

Properties

- Material: steel Q235B
- Zinc plating: electro zinc-plated, min. 5 µm

Technical data

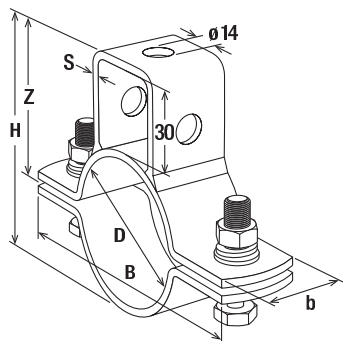

FSSC-FM

Item	Item No.	FM approved	Clamping range	Width		Width x thickness clamp band b x s [mm]	Height Z	Max. recom. static load (centr. tension) N _{recom.} [kN]	Sales unit [pcs]
			D [mm]	B [mm]	H [mm]		Z [mm]		
FSSC-FM 73 gvz	547765	X	73	161	127	40 x 4,0	87	5.0	24
FSSC-FM 76 gvz	547766	X	76	164	130	40 x 4,0	88	6.00	24
FSSC-FM 89 gvz	547767	X	89	177	143	40 x 4,0	95	6.00	15
FSSC-FM 108 gvz	547768	X	108	196	162	40 x 4,0	104	6.00	15
FSSC-FM 114 gvz	547769	X	114	202	172	40 x 6	109	12.00	12
FSSC-FM 133 gvz	547770	X	133	221	191	40 x 6	119	12.00	12
FSSC-FM 139 gvz	547771	X	139	227	197	40 x 6	122	12.00	12
FSSC-FM 159 gvz	547772	X	159	247	217	40 x 6	132	13.00	10
FSSC-FM 168 gvz	547773	X	168	256	226	40 x 6	136	13.00	10

Channel clamp FUSF

Channel clamp FUSF for a safe installation and bracing of FUS channel profiles



Bracing of channel construction

2f

Applications

- Channel clamp FUSF for a safe installation and bracing of FUS channel profiles

Advantages/Benefits

- The channel clamp FUSF increases the load capacity of channel constructions.
- The seismic braces can be fixed to the channel clamp at different angles to provide maximum flexibility during subsequent fixing and bracing.

Properties

- Material: steel Q235B
- Zinc plating: electro zinc-plated, min. 5 µm

Technical data

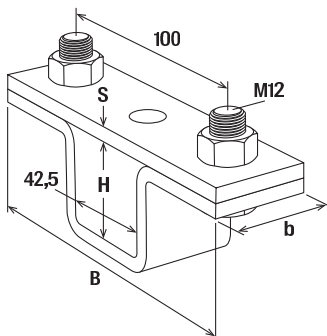

FUSF

Item	Item No.	For profile	Width	Height	Width x thickness clamp band b x s [mm]	Sales unit [pcs]
			B [mm]	H [mm]		
FUSF 41 gvz	547783	FUS 41	140	41	40 x 6	20
FUSF 62 gvz	547784	FUS 62	140	62	40 x 6	15
FUSF 41D gvz	547785	FUS 41 D	140	82	40 x 6	15
FUSF 62D gvz	547786	FUS 62 D	140	124	40 x 6	10

Sway brace bracket FSF

Sway brace bracket FSF with FM approval for both lateral and longitudinal sway brace applications



Bracing of pipeline with channel profiles

2f

Applications

- Connecting element for stable connections between two channel profiles or one channel profile and the substrate
- For bracing frame constructions with FUS channel profiles

Certificates



Advantages/Benefits

- The sway brace bracket for connecting FUS channel profiles provides very high stability and safety to a supporting structure.
- The exact fit of the sway brace bracket and the FUS channel profiles enables quick and easy channel connection.
- The FM-approval of the FSF sway brace bracket guarantees objectively tested functional safety.

Properties

- Material: steel Q235B
- Zinc plating: electro zinc-plated, min. 5 µm

Technical data

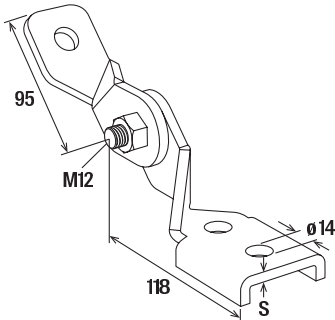

FSF-FM

Item	Item No.	FM approved	For profile	Material thickness [mm]	Sales unit [pcs]
FSF-FM gvz	547763	X	FUS 21, 41, 62, 21D, 41D, 62D	6	10

Shaped reinforcement strut SAE

Shaped reinforcement strut for bracing FUS channel profiles and FCA cantilevers



Bracing of cantilever construction

2f

Applications

- Seismic bracing of framework constructions with FUS channels and FCA cantilevers

Properties

- Material: Steel S235JR (material no. 1.0038) acc. to DIN EN 10025-2
- Zinc plating: electro zinc-plated, min. 5 μm

Technical data

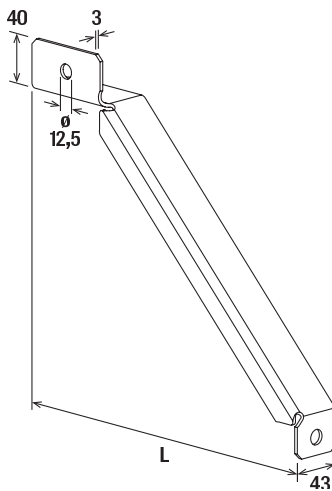

SAE

Item	Item No.	Thickness	Length	Sales unit
		[mm]	L [mm]	[pcs]
SAE 300	512114	3	300	10
SAE 500	512115	3	500	10

Threaded rod brace connector S-VA

Threaded rod brace connector S-VA with maximum installation flexibility for seismic bracing with threaded rods



Bracing of frame construction with threaded rods

2f

Applications

Advantages/Benefits

Properties

- The design of the threaded rod brace connector S-VA allows a variable fixation at angles between 30° and 65° for a flexible adaptation to new and already existing construction.
- The design of the bracing element allows easy and quick insertion of a pre-mounted threaded rod with nut.
- The possibility to mount two bracing elements on top of each other offers the option to clamp the same point in different directions.

- Material bracket: steel S275JR (material-no. 1.0044) according to DIN EN 10025-2
- Material supporting plate: steel S355MC (material no. 1.0976) according to DIN EN 10149-2
- Screw: M10x45, strength class 8.8, galvanised steel
- Nut: M10, strength class 8, galvanised steel

Technical data

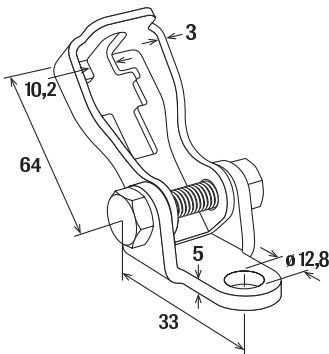

S-VA

Item	Item No.	For profile	Material thickness [mm]	Thickness base [mm]	Threaded rod Ø x length [mm]	Sales unit [pcs]
S-VA	552360	FUS, FLS	3	5		10

Channel brace connector S-VB

Channel brace connector for seismic bracing of framework constructions with FUS channel profiles



Bracing of frame construction with channel profiles

2f

Applications

- For seismic bracing of new as well as already installed framework constructions with FUS channel profiles

Advantages/Benefits

- The design of the channel brace connector S-VB allows a variable fixation at angles between 30° and 65° for a flexible adaptation to new and already existing construction.
- The lamellae bent upwards and downwards allow the easy installation of the channel profile to the channel brace connector.
- The possibility to mount two channel brace connectors on top of each other offers the option to clamp the same point in different directions.

Properties

- Material bracket: steel S275JR (material-no. 1.0044) according to DIN EN 10025-2
- Material supporting plate: steel S355MC (material no. 1.0976) according to DIN EN 10149-2
- Screw: M10x45, strength class 8.8, galvanised steel
- Nut: M10, strength class 8, galvanised steel

Technical data

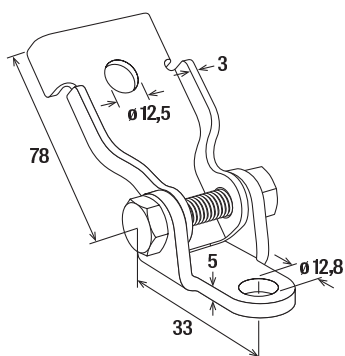

S-VB

Item	Item No.	Thickness	Thickness base	For profile	Sales unit
		[mm]	[mm]		[pcs]
S-VB	552362	3	5	FUS	10

90° angle connector S-FAF

90° angle connector to connect two FUS channel profiles and install seismic bracing elements S-VA and S-VB



Connection of channel profiles and bracing elements

2f

Applications

- 90° angle connector for the connection of channel profiles and the installation of bracing elements

Advantages/Benefits

- Perforated wings allow an easy and quick installation of the brace connectors S-VA and S-VB on the angle connector S-FAF.
- The seismic angle connector allows an easy and flexible installation of the brace connectors S-VA and S-VB at different angles.

Properties

- Material: steel S275JR (material-no. 1.0044) according to DIN EN 10025-2
- Zinc plating: electro zinc-plated, min. 5 µm

Technical data

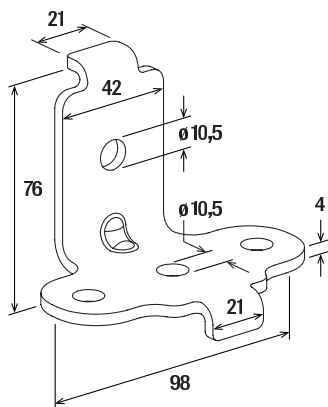

S-FAF

Item	Item No.	For profile	Material thickness [mm]	Sales unit [pcs]
S-FAF	552363	FUS	4	10

Threaded rod connector S-ROD

Threaded rod brace connector with increased angle adjustability to install threaded rods for seismic bracing



Bracing of pipeline with threaded rods

2f

Applications

- For the seismic bracing of suspended threaded rods as well as new and existing frame constructions with threaded rods M10

Advantages/Benefits

- The design of the threaded rod brace connector allows a variable installation at angles between 30° and 65°.
- The threaded rod connector can be installed quickly and easily without having to dismantle already existing installations.
- By tilting the side rod by 90°, the threaded rod connector slides very easily, allowing easy and quick adjustment of the assembly height on the vertical threaded rod.
- The threaded rod connectors can be mounted on top of each other to brace the same point in different directions.

Properties

- Material U-shaped brackets: steel S275JR (material-no. 1.0044) according to DIN EN 10025-2
- Material threaded rod: steel 11SMnPb37 (material-no. 1.0737) according to DIN EN 10277-3
- Zinc plating: electro zinc-plated, min. 5 µm

Technical data

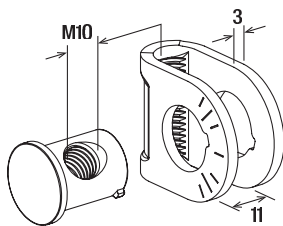

S-ROD

Item	Item No.	Material thickness	Sales unit
		[mm]	[pcs]
S-ROD	552361	3	10

Rod stiffener FTRC M12 gvz

Rod stiffener FTRC M12 gvz for attaching strut channel to a threaded rod to accommodate compression loads

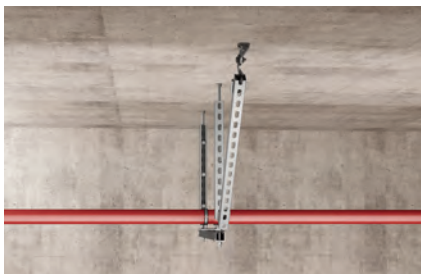

Rod stiffening for vertical seismic support

2f

Applications

- For the reinforcement of existing suspended constructions due to bracing of threaded rods M10 or M12 to FUS channel profiles
- For attaching strut channel to a threaded rod to accommodate compression loads

Advantages/Benefits

- The pronounced interlocking of the rod stiffeners gives a secure hold in the channel profile and holds the threaded rod in the desired position.
- The exact fit of the rod stiffeners enables quick and easy assembly.
- The assembly enables subsequent insertion in already installed channel profiles by 90° rotation.

Properties

- Material: Steel S235JR (material no. 1.0038) acc. to DIN EN 10025-2
- Zinc plating: electro zinc-plated, min. 5 µm

Technical data

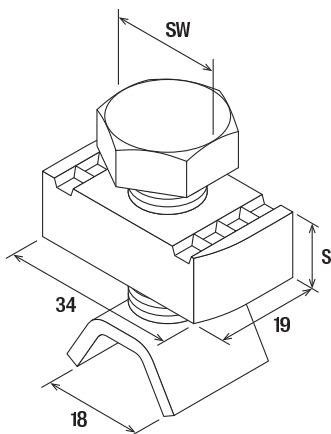

FTRC

Item	Item No.	Thread M	Material thickness [mm]	Width across nut SW [mm]	Tightening torque T_{inst} [Nm]	Sales unit [pcs]
FTRC M12 gvz	547791	M 12	12	19	20	50

Torque bolt SKS M12x30

Torque bolt for secure fixing of connection elements on mounting channels



2f

Applications

- Torque bolt for secure fixing of connection elements on channel profiles

Advantages/Benefits

- The torque bolt SKS can be mounted quickly and easily.
- The attached hexagon head ensures that the optimum torque is applied and the screw is tightened to the maximum.

Properties

- Zinc plating: electro zinc-plated, min. 5 µm
- Material: steel SAE J403 according to DIN EN 10132-4
- Torque range: 50-60 Nm

Technical data

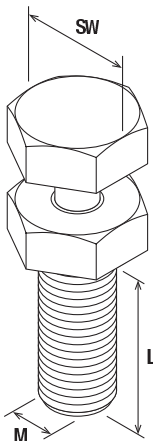

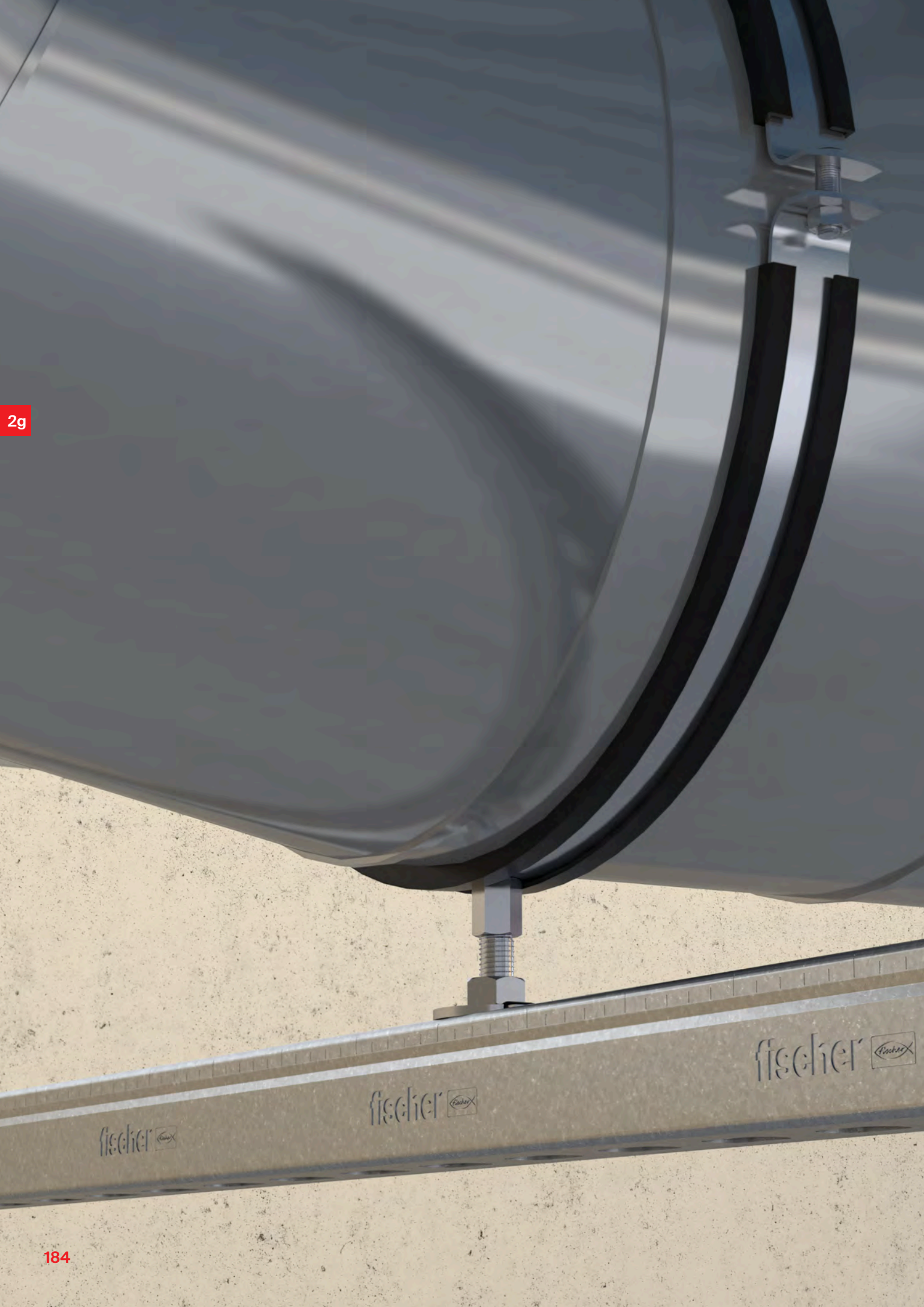

SKS M12

Item	Item No.	Thread M	Length L [mm]	Width across nut SW [mm]	Sales unit [pcs]
SKS TB M12x30	552441	M 12	30	19	100



2g

fischer 

fischer 

fischer 

2g

Air duct and metal roof fixings

Ventilation duct clamp LGS	186	
Duct hanger L- and Z-type	188	
Spiral duct hanger LRBN / LRB	190	
Profile hanger TZ / TZH	192	
Hole punch LZ, hole stamp LST	194	
Rubber inlay EMS	195	
Profile connecting screws FPS-FPB	196	

Ventilation duct clamp LGS

Clamps - Ventilation duct clamp LGS



Support systems for ventilation



Spiral airduct on cantilever

2g

Applications

- Fixing of spiral lock seam pipes
- Fixing of pipes over 450 mm in diameter with two adjacent threaded rods
- Sound-insulation insert is held glued from Ø450 mm

Advantages/benefits

- The large opening angle of the LGS enables a quick and easy installation.
- The LGS's two screws allow the adjustment to suit the outer pipe diameter.
- The locking screw with large recess/cross recess head is secured to not get lost during installation.
- The sound-insulation insert has a form fit and can not fall out during the adjustment of the pipe.
- The LGS is drilled on both sides of the clamp from 450 mm diameter on. This allows for connection with two screws with nuts or two threaded rods with nuts. Thereby the recommended load of the clamp can be doubled.

Properties

- Material: steel DC01 (material no. 1.330) acc. to DIN EN 10130
- Zinc plating: electro zinc-plated, 5 - 9 µm
- Connecting nut: resistance welded domed nut, M8 / M10, SW 13
- Locking screw: oval head screw with combination recessed head
- Material sound insulation insert: SBR/EPDM; chlorine-free; silicone-free
- Sound insulation: for DIN 4109
- Temperature range: -50 °C to +110 °C
- Hardness: 45 ± 5° Shore A
- Fire behaviour: DIN 4102: Class B2

Installation LGS

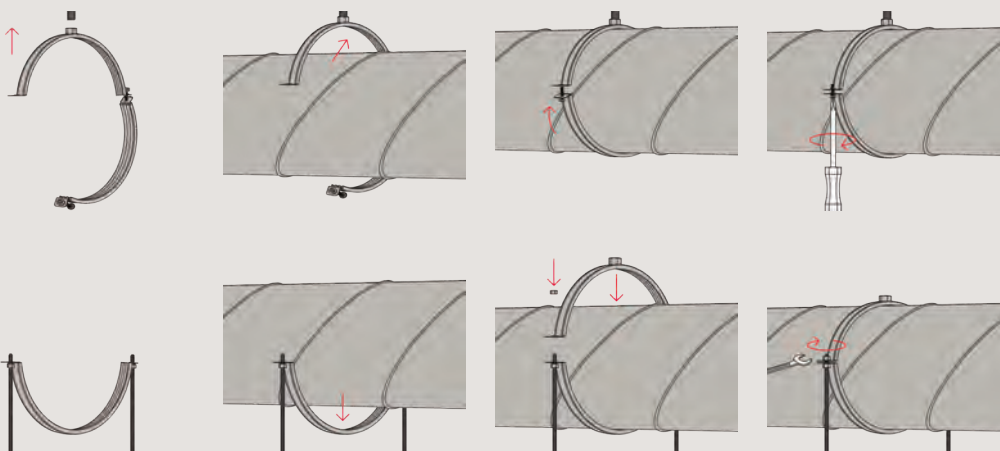

Technical data

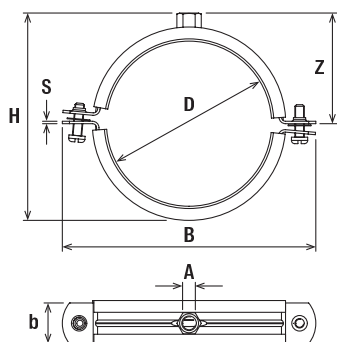

LGS

Item	Item No.	Thread	Size	Height	Width	Width x thickness clamp band	Height Z	Locking screw	Max. recom. static load (centr. tension) [kN]	Sales unit [pcs]
		A	D [mm]	H [mm]	B [mm]	b x s [mm]	Z [mm]			
LGS 80	079491	M 8 / M 10	80	108	133	25 x 1,5	62	M 6	0.6	25
LGS 90	079492	M 8 / M 10	90	118	143	25 x 1,5	67	M 6	0.6	25
LGS 100	079493	M 8 / M 10	100	128	153	25 x 1,5	72	M 6	0.6	20
LGS 112	079494	M 8 / M 10	112	140	165	25 x 1,5	78	M 6	0.6	20
LGS 125	079495	M 8 / M 10	125	153	178	25 x 1,5	85	M 6	0.6	10
LGS 140	079496	M 8 / M 10	140	168	193	25 x 1,5	92	M 6	0.6	10
LGS 150	079497	M 8 / M 10	150	178	203	25 x 1,5	97	M 6	0.6	10
LGS 160	079498	M 8 / M 10	160	188	213	25 x 1,5	102	M 6	0.6	10
LGS 180	079499	M 8 / M 10	180	208	233	25 x 1,5	112	M 6	0.6	10
LGS 200	079500	M 8 / M 10	200	228	253	25 x 1,5	122	M 6	0.6	15
LGS 224	079501	M 8 / M 10	224	252	280	25 x 1,5	134	M 6	0.6	15
LGS 250	079502	M 8 / M 10	250	278	306	25 x 1,5	147	M 6	0.6	10
LGS 280	079503	M 8 / M 10	280	308	336	25 x 1,5	162	M 6	0.6	10
LGS 300	079504	M 8 / M 10	300	328	356	25 x 1,5	172	M 6	0.6	10
LGS 315	079505	M 8 / M 10	315	343	371	25 x 1,5	180	M 6	0.6	10
LGS 355	079506	M 8 / M 10	355	383	410	25 x 1,5	200	M 6	0.6	10
LGS 400	079507	M 8 / M 10	400	428	455	25 x 1,5	222	M 6	0.6	10
LGS 450	024637 ¹⁾	M 8 / M 10	450	480	510	25 x 2,5	248	M 10	0.8	1
LGS 500	024638 ¹⁾	M 8 / M 10	500	530	560	25 x 2,5	273	M 10	0.8	1
LGS 560	024639 ¹⁾	M 8 / M 10	560	590	620	25 x 2,5	303	M 10	0.8	1
LGS 600	024640 ¹⁾	M 8 / M 10	600	630	661	25 x 2,5	323	M 10	0.8	1
LGS 630	542960 ¹⁾	M 8 / M 10	630	660	691	25 x 2,5	338	M 10	0.8	1
LGS 710	542962 ¹⁾	M 8 / M 10	710	740	771	25 x 2,5	378	M 10	0.8	1
LGS 800	024643 ¹⁾	M 8 / M 10	800	831	861	25 x 3,0	424	M 10	0.8	1
LGS 900	024644 ¹⁾	M 8 / M 10	900	931	960	25 x 3,0	474	M 10	0.8	1
LGS 1000	024645 ¹⁾	M 8 / M 10	1000	1031	1060	25 x 3,0	527	M 10	0.8	1
LGS 1120	024646 ¹⁾	M 8 / M 10	1120	1151	1183	25 x 3,0	584	M 10	0.8	1
LGS 1250	024647 ¹⁾	M 8 / M 10	1250	1281	1313	25 x 3,0	649	M 10	0.8	1

¹⁾ The installation with two threaded rods allows to double the given recommended loads.

2g

Duct hanger L- and Z-type

Fastening components - Duct hanger L- and Z-type



Airduct under steel beam with beam clamp



Suspended airduct

2g

Applications

- Fastening component with sound-insulation

Advantages/benefits

- The ceiling hanger's sound-insulation element reduces the transfer of vibration and noise.
- The multiple holes on the ceiling attachments allow a quick and easy fastening with self-drilling screws or rivets.
- The through hole in the ceiling hangers allows a simple alignment and height adjustment of the threaded rod.

Properties

- Material: steel DD11 (material no. 1.0332) acc. to DIN EN 10111
- Zinc plating: electro zinc-plated, min. 3 µm
- Sound insulation: for DIN 4109
- Temperature range: -50 °C to +110 °C
- Hardness: 45 ± 5° Shore A
- Fire behaviour: DIN 4102: Class B2

Technical data

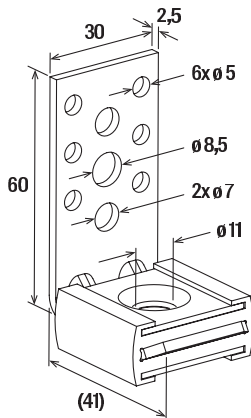

LKHN

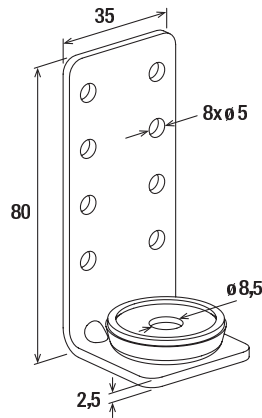

LKH

Item	Item No.	For thread	Max. recom. static load (centr. tension) N _{recom.} [kN]	Sales unit [pcs]
LKHN	516537	M 8 / M 10	0.90	50
LKH	024671	M 8	0.50	50

Technical data

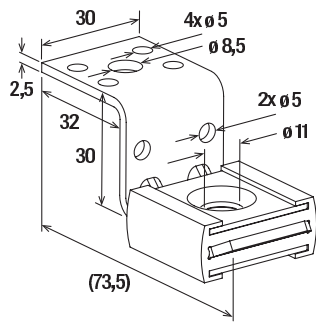

ZKHN

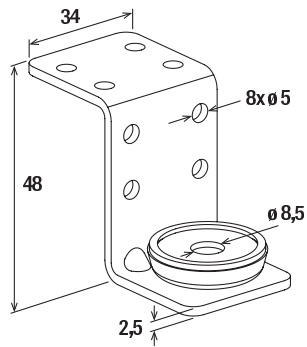

ZKH

Item	Item No.	For thread	Max. recom. static load (centr. tension) N _{recom.} [kN]	Sales unit [pcs]
ZKHN	516540	M 8 / M 10	0.90	50
ZKH	024674	M 8	0.50	50

2g

See also

Profile connector
FPS-FPB



Spiral duct hanger LRBN / LRB

Fastening components - Spiral duct hanger LRB and LRBN



Spiral duct pipe with sound insulated hanger

2g

Applications

- Fastening component with sound-insulation (riveted and inserted versions)

Advantages/benefits

- The multiple holes on the duct hangers allow a quick and easy fastening with self-drilling screws or rivets.
- The duct hangers sound-insulation element reduces the transfer of vibration and noise.
- The through hole in the duct hangers allows the simple alignment and height adjustment of the threaded rod.
- The riveted version gives the ceiling hanger increased stability.
- The specified shape of the duct hangers allow an ideal adjustment to suit the pipe diameter.
- The design of the LRN / LRNB offers an alternative use as a sound-insulated profile hanger.

Properties

- Material LRB: steel DD11 (material no. 1.0332) acc. to DIN EN 10111
- Zinc plating LRB: electro zinc-plated, min. 3 µm
- Material LRBN: steel S235 JR (material no. 1.0037) acc. to DIN EN 10025
- Zinc plating LRBN: electro zinc-plated, min. 8 µm
- Sound insulation: for DIN 4109
- Temperature range: -50 °C to +110 °C
- Hardness: 45 ± 5° Shore A
- Fire behaviour: DIN 4102: Class B2

Technical data

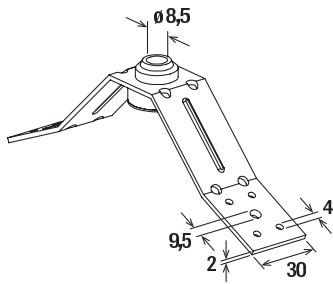

LRB

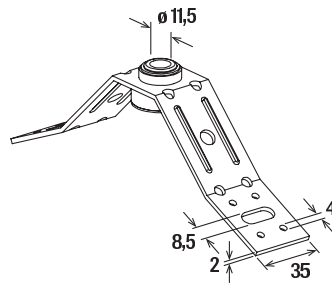

LRBN

Item	Item No.	For thread	Max. recom. static load (centr. tension)	Sales unit
			[kN]	[pcs]
LRB	024675	M 8	0.5	50
LRBN	077613	M 8 / M 10	0.9	50

2g

See also

Profile connector
FPS-FPB



Profile hanger TZ / TZA / TZH

Metal ceiling hanger - Profile hanger TZ / TZA / TZH

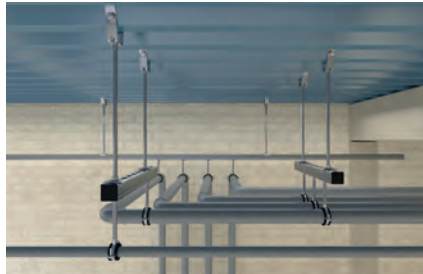

Suspended pipes on trapezoid roof

2g

Applications

- Fastening element for trapezoidal sheets (available in three versions)
- Sprinkler system version to be fixed with screw SKS M8x100 in punched hole
- Fixing of pipes with self drilling screws or steel blind rivets

Advantages/benefits

- The VdS approval for TZ/TZH and the FM approval for the TZA guarantee independently tested safety.
- The TZH's adjustable nut allows a simple, post-installation height adjustment.
- The specified bending points of the TZ/TZH/TZA allow the ideal adjustment to suit the shape of the trapezoidal sheet.

Properties

- Material: steel DX51D+Z 140-275 (material no. 1.0226+Z) acc. to DIN EN 10327; DD11 acc. to DIN EN 10111
- Zinc plating: electro zinc-plated, $\geq 7 \mu\text{m}$

Certificates



G 410037 / G 410034



from M10

Installation TZ/TZH

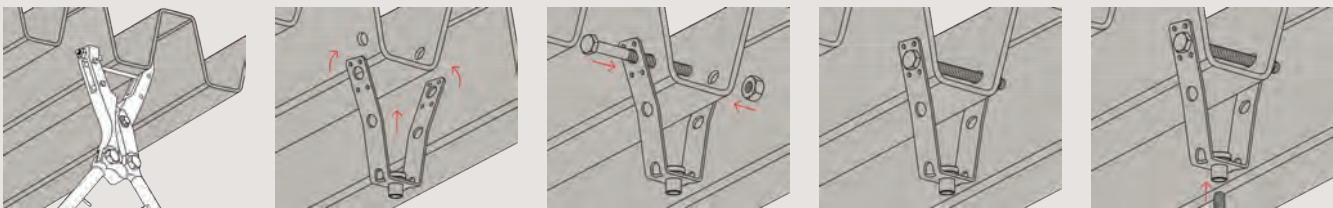

Technical data

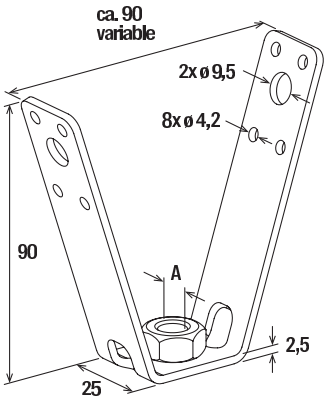

TZ

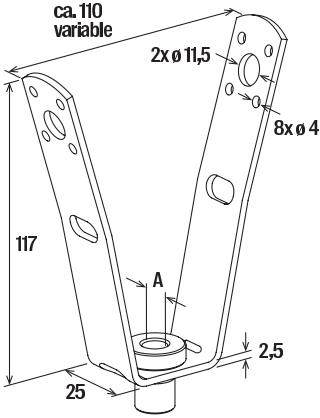

TZH

Item	Item No.	VdS approved	FM approved	Thread A	Max. recom. statc load (centr. tension) [kN]	Sales unit [pcs]
TZ M 8	064094	X	—	M 8	3.0	25
TZH M 8	079825	X	—	M 8	4.0	25
TZA M10	524047	—	X	M 10	3.0	50
TZ M 10	064095	X	—	M 10	3.0	25
TZH M 10	079826	X	—	M 10	4.0	25

2g

Hole punch LZ, hole stamp LST

Hole punch for punching trapezoidal sheet roofs



2g

Applications

- Tool for punching holes in trapezoidal steel sheets

Advantages

- The hole punch LZ enables easy handling during use.
- Thanks to the long lever, only a little force is required to use it.
- The LST hole stamp can be replaced if it shows signs of wear.

Properties

- Usable for trapezoidal steel sheets with max. opening width of 100 mm
- Max. sheet thickness 1,25 mm
- Hole punch diameter 10 mm
- Adjustable depth stop for accurate adjustment
- Stamp with ejector springs for easy ejection of stamps from metal sheet
- Rubber handles for better grip
- Long lever and hinges for better power transmission

Technical data

Item	Item No.	Max. sheet thickness [mm]	Hole punch diameter [mm]	Opening width [mm]	Sales unit [pcs]
LZ	079830	1.25	10	100	1

Technical data



Hole stamp LST

Item	Item No.	Hole punch diameter [mm]	Sales unit [pcs]
LST 10	079829	10	2

Rubber inlay EMS

Fastening components - Rubber inlay EMS

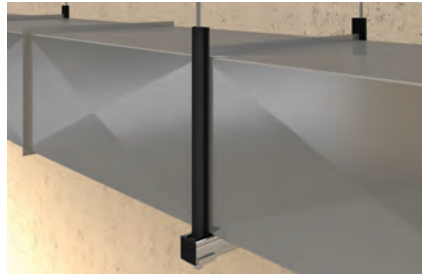

Airduct with sound insulation on installation channel

Applications

- Profile rubber to insert in channels
- Sound insulation of large ducting

Advantages/benefits

- The channel rubber EMS provides sound insulation between components.
- The design of the rubber EMS allows it to be used in channels and threaded rods.

Properties

- Material sound insulation: SBR/EPDM chlorine-free and silicone-free
- Sound insulation: special noise-absorbing lining
- Temperature range: -50 °C to +110 °C
- Hardness: 45 ± 5° Shore A
- Fire behaviour: DIN 4102: Class B2

2g

Technical data

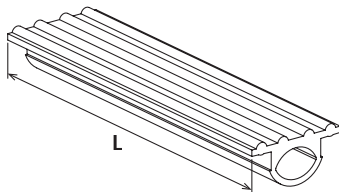

EMS

Item	Item No.	For profile	Length [m]	Sales unit [pcs]
EMS 31	538752	all FLS channels	25	1
EMS 41	550806	all FUS channels	6	1

Profile connecting screws FPS-FPB



Suspended pipes on trapezoid roof

2g

Applications

- Suitable for fastening duct hangers and spiral duct hangers to air ducts and spiral air ducts.

Advantages

- The screw is self drilling and does not require a drilling machine.

Properties

- Material: steel
- Zinc plating: electro zinc-plated

Technical data

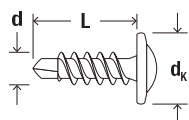



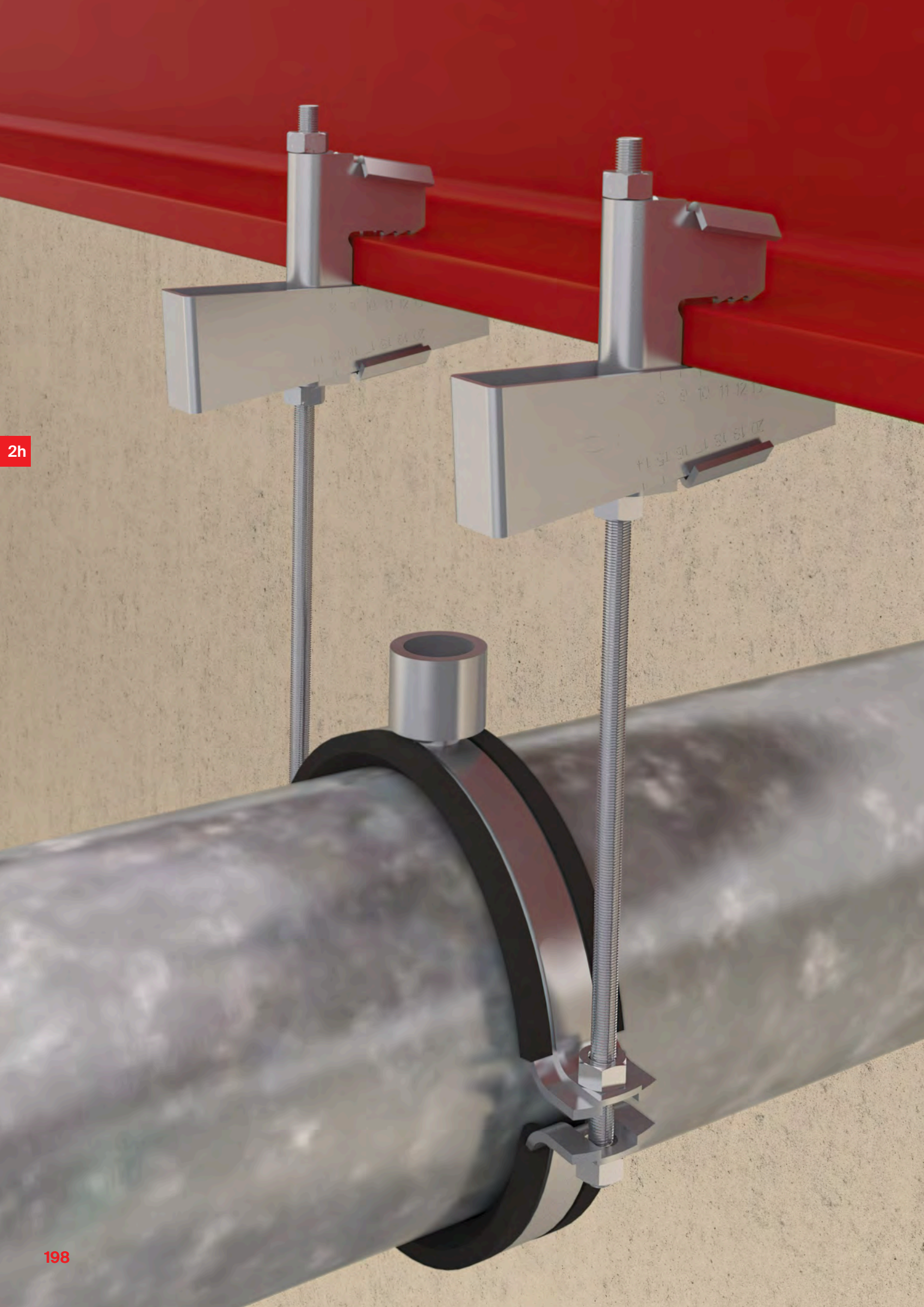





















Item	Item No.	Diameter d [mm]	Length L [mm]	Head-Ø d _k [mm]	Thread length l _g [mm]	Drive	Sales unit [pcs]
FPS-FPB 4,2 x 13 ZPF 1000	040457	4.2	13	9.6	13	PH 2	1000



2h

2h

Accessories

Clamp hanger TKL	200		Hexagonal screw SKS	214	
Beam Clamp Steel TKLS Steel Bite	202		Washer U	214	
Threaded rod G	204		Hexagonal nut MU	215	
Threaded stud GS	204		Hexagonal connector VM	215	
Base plate GPL	206		Eyebolt AG	216	
Stud screw STST with torx	207		Thread hanger RAH	216	
Support hanger AHB	209		Reduction piece RD	217	
Multi connector MW	210		Reduction socket RDM and GRD	217	
Parallel connector PV	211		Flat eye screw LLS	218	
Double connector plate DPP, DPF	212		Textile web strapping GWB	219	
Bolt connector SBB	213		Perforated steel banding LBV / LBK	220	
Turnbuckle SPS	213		Impact nail ED	222	

2h

Clamp hanger TKL



Heavy drainage pipe on beam clamp

2h

Applications

- Clamp hangers allow for simple fixing by clamping direct to steel girders
- Safety plates SS-TKL are required for VdS equipment over \varnothing 65 mm

Certificates



G 410037 / G 410034



from M10



Advantages/benefits

- The TKL design with its clamping screw allows for fixing to steel girders without the need for welding and drilling.
- The design of the clamping screw prevents it from slipping from the steel girder.
- VdS/FM/UL certificates guaranty independently tested safety.
- The solid TKL design guarantees a high load-bearing capacity.
- The TKL with locking screw guarantees quick and easy installation.
- The TKL with through-hole allows for height adjustment after installation.

Properties

- Material TKL: malleable cast iron EN-GJMB-350-10 acc. to DIN 1562
- Material bolt: steel 8.8 acc. to ISO 4017
- Material nut: steel acc. to ISO 4035, Strength category 4
- Material SS-TKL: steel DX51D (material no. 1.0226) acc. to EN 10214
- Zinc plating: electro zinc-plated, min. 5 μ m

Installation TKL

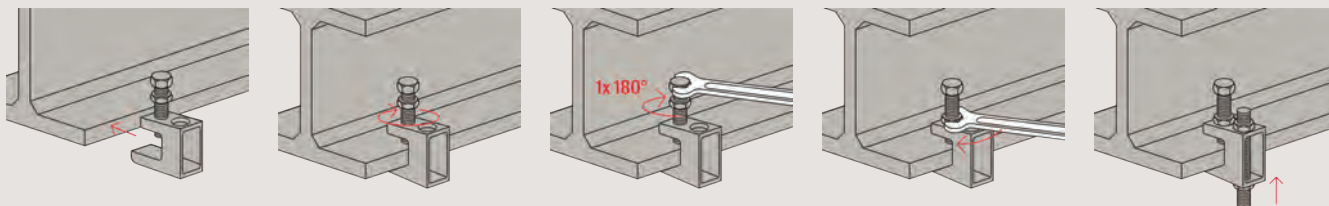

Technical data

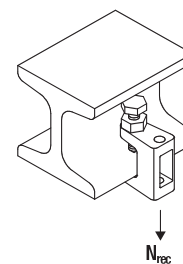
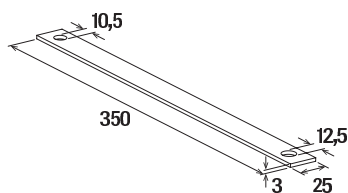
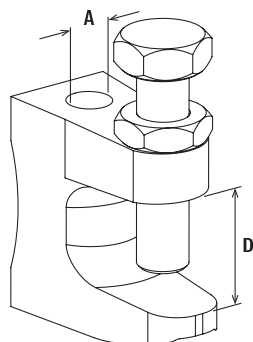

TKL

SS-TKL

Item	Item No.	VdS approved	FM approved	UL approved	Clamping range		Max. recom. static load (centr. tension) $N_{recom.}$ [kN]	Sales unit [pcs]
					D [mm]	A		
TKL L M 8	064055	X	—	—	0 - 18	M 8	1.20	50
TKL M 8	079687	X	—	—	0 - 23	M 8	2.50	50
TKL L Ø 9	077605	X	—	—	0 - 18	Ø 9	1.20	50
TKL M 10	079688	X	X	X	0 - 20	M 10	2.50	50
TKL Ø 11	079689	X	X	X	0 - 20	Ø 11	2.50	50
TKL M 12	020949	X	X	X	0 - 26	M 12	3.50	50
TKL Ø 13	043275	X	X	X	0 - 26	Ø 13	3.50	50
SS-TKL M10/M12	048154	X	—	—	—	Ø 10 / Ø 12	—	25

2h

Beam Clamp Steel TKLS Steel Bite

Clamp hangers for easy fixing to steel girders with just one tool

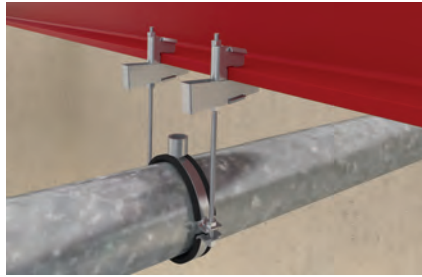

Heavy steel pipe suspended on steel beam

2h

Applications

- All kind of fixings by threaded rods to steel beams with sloping flange plate up to 14%
- Safety plates SS-TKL are required for VdS equipment over \varnothing 65 mm

Certificates



from M10



G 410037 / G 410034

Advantages/benefits

- The TKLS design with hammering wedge allows fixing to steel beams without the need of welding and drilling.
- The teeth of the TKLS Steel Bite effectively prevent from slipping of the steel beam.
- VdS and FM approval guarantees objectively tested functional safety.
- The TKLS Steel Bite made of steel guarantees highest load-bearing capacity.
- The TKLS Steel Bite allows pre-assembly of threaded rods and for retrospective height adjustment.

Properties

- TKLS: material: steel HX420LAD+ZAD, material no. 1.0935, DIN EN 10346
- TKLS: Zinc plating: electro zinc-plated, min. 7 μ m
- SS-TKL: Material: steel DX51D acc. to EN 10214, material no.1.0226
- SS-TKL: Zinc plating: electro zinc-plated, min. 5 μ m

Installation TKLS

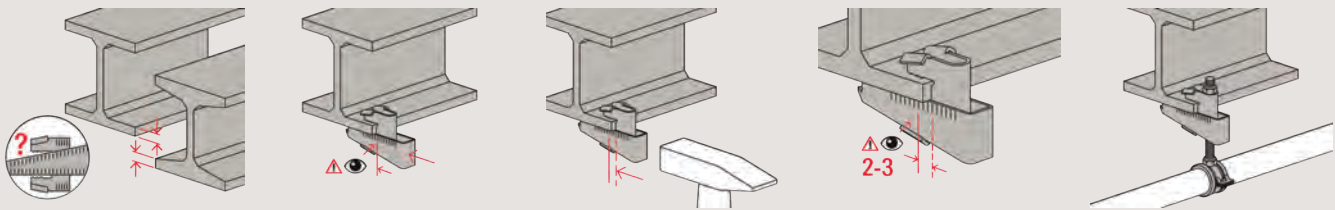

Technical data

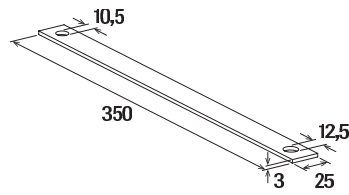
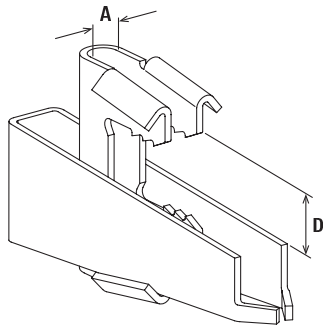

TKLS

SS-TKL

Item	Item No.	VdS approved	FM approved	Hole-Ø D [mm]	Clamping range D [mm]	Max. recom. static load (centr. tension) $N_{recom.}$ [kN]	Max. recom. pipe-Ø acc. VDS CEA 4001	Sales unit [pcs]
TKLS Ø 9	531134	X	—	9	8 - 20	2.00	≤ DN 50	25
TKLS Ø 11	531136	X	X	11	8 - 20	3.50	> DN 50 ≤ DN 100	25
TKLS Ø 13	531137	X	X	13	8 - 20	5.00	> DN 100 ≤ DN 200	25
TKLS Ø 17	531138	X	X	17	11 - 26	10.0	> DN 200 ≤ DN 250	16
SS-TKL M10/M12	048154	X	—	—	—	—	—	25

2h

Threaded rod G



Properties

- Material threaded rod G (G 6 - G 24): DIN 976 steel 4.8 acc. to DIN EN ISO 898-1
- Material threaded pipe G (G 1/2" - G 3/4"): steel S235 JR (material no. 1.0037) acc. to DIN EN 10025
- Zinc plating: electro zinc-plated, min. 3 µm

2h

Technical data

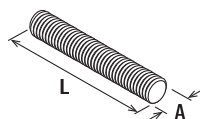
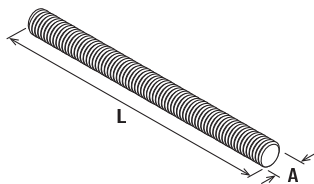

G

GS

Item	Item No.	Length L [mm]	Thread A	Sales unit [pcs]
G 6	020956	1000	M 6	50
G 8	079740	1000	M 8	25
G 10	079744	1000	M 10	25
G 12	020957	1000	M 12	20
G 16	020958	1000	M 16	10
G 20	557295	1000	M 20	5
G 24	557270	1000	M 24	5
G 8/2	079741	2000	M 8	25
G 10/2	079745	2000	M 10	25
G 12/2	579746	2000	M 12	25
G 10/3	557092	3000	M 10	5
G 12/3	064056	3000	M 12	5
G 1/2"	064093	2000	1/2"	10
G 3/4"	077580	2000	3/4"	5
GS 6/25	544589	25	M 6	100
GS 6/40	544590	40	M 6	100
GS 6/50	544591	50	M 6	100
GS 6/70	544592	70	M 6	100
GS 6/80	544593	80	M 6	100
GS 6/100	544594	100	M 6	100
GS 8/25	079750	25	M 8	100
GS 8/40	079751	40	M 8	100
GS 8/50	079752	50	M 8	100
GS 8/60	079753	60	M 8	100
GS 8/70	079754	70	M 8	100
GS 8/80	079755	80	M 8	100
GS 8/100	079757	100	M 8	100
GS 8/120	535535	120	M 8	50
GS 8/150	079758	150	M 8	50
GS 8/180	535536	180	M 8	50
GS 8/200	079759	200	M 8	50

Technical data

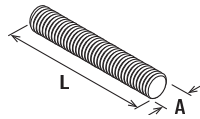
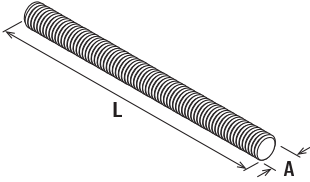

G

GS

Item	Item No.	Length L [mm]	Thread A	Sales unit [pcs]
GS 10/25	079765	25	M 10	100
GS 10/40	079766	40	M 10	100
GS 10/60	079767	60	M 10	100
GS 10/80	079768	80	M 10	100
GS 10/100	079769	100	M 10	100
GS 10/120	079770	120	M 10	50
GS 10/150	079771	150	M 10	50
GS 10/200	079772	200	M 10	50
GS 12/40	091442	40	M 12	100
GS 12/60	091443	60	M 12	100
GS 12/80	091444	80	M 12	100
GS 12/100	091461	100	M 12	100
GS 12/120	091462	120	M 12	50
GS 12/150	091463	150	M 12	50
GS 12/200	091464	200	M 12	50

Loads

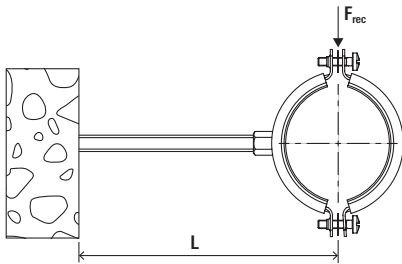

Threaded rods (4.6)

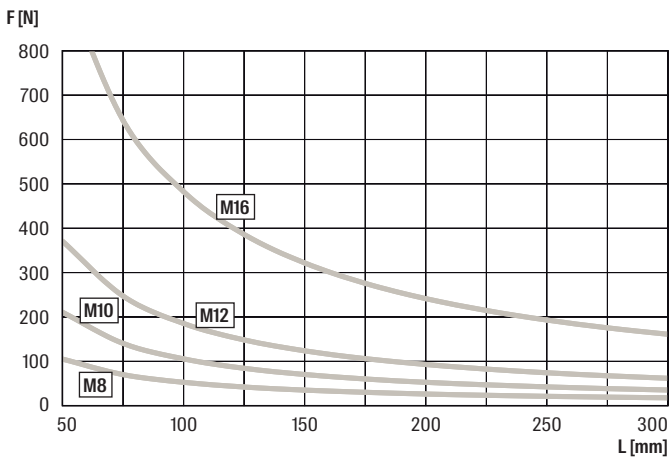

Threaded pipes

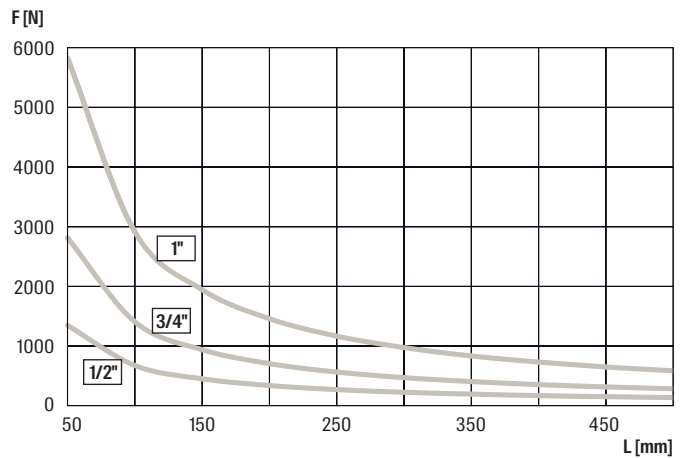

Base plate GPL

Base plates GPL / GPS for dimensionally stable connections between the substrate and pipeline



Baseplate on installation channel



Plastic pipe with fixpoint installation

Applications

- Creation of dimensionally stable connections between the substrate and pipeline

Advantages/benefits

- The base plate's slots allow easy alignment.

Properties

- Material: steel DD11 (material no. 1.0332) acc. to DIN EN 10111
- Zinc plating: electro zinc-plated, min. 8 µm

Technical data

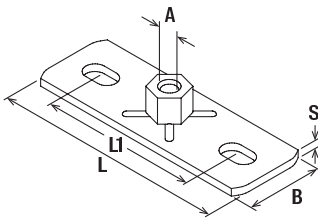

GPL / GPS

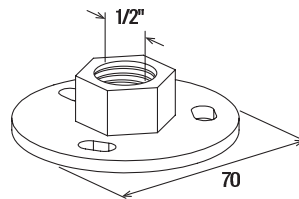

GPR

Item	Item No.	Thread	Length	Width	Hole spacing	Slot	Thickness	Max. recom. static load (centr. tension) N _{recom.} [kN]	Sales unit [pcs]
		A	L [mm]	B [mm]	Li [mm]	l x s [mm]	S [mm]		
GPL M 8	079665	M 8	80	30	54	9 x 16	3	2.40	25
GPL M 10	079666	M 10	80	30	54	9 x 16	3	2.40	25
GPL M 8/M 10	553637	M 8 / M10	80	30	54	9 x 18	3	2.40	25
GPL 1/2"	079667	1/2"	80	30	54	9 x 16	3	4.00	25
GPS M 10	079671	M 10	120	40	79	11 x 19	4	6.00	25
GPS M 12	040398	M 12	120	40	79	11 x 19	4	6.00	25
GPS M 16	504408	M 16	120	40	79	11 x 19	4	8.00	25
GPS 1/2"	079672	1/2"	120	40	79	11 x 19	4	8.00	25
GPS 3/4"	020968	3/4"	120	40	79	11 x 19	4	8.00	25
GPR 1/2"	037289	1/2"	—	—	—	11 x 7	4	4.00	25

Stud screw STST with TX star recess

Stud screw STST for the direct mounting of pipe clamps to the substrate

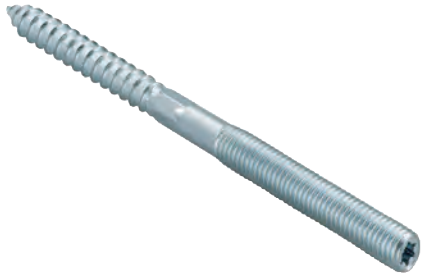

Applications

- Threaded connectors stud screw STST
- Wood and metric screw combination for direct installation of clamps onto a wall

Advantages/benefits

- Fixing with a Nylon plug to brick or direct into timber construction is simple with the TX drive or the integrated hexagon.

Properties

- Material: steel 4.6 acc. to DIN EN ISO 898-1
- Zinc plating: electro zinc-plated, min. 3 µm

2h

Installation STST

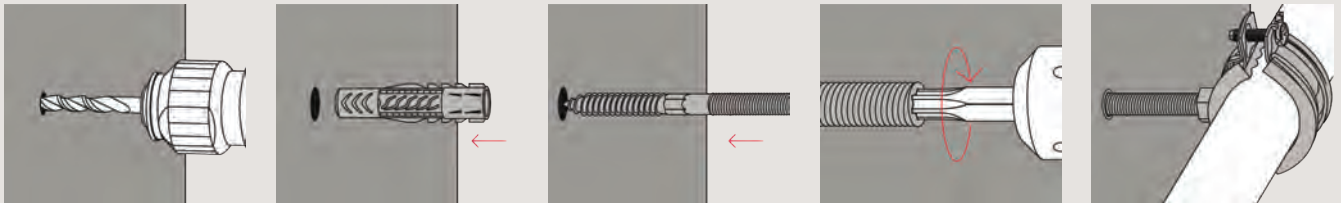

Technical data

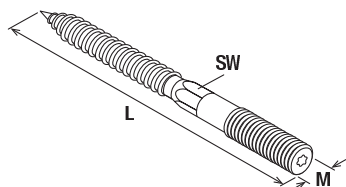

STST

Item	Item No.	Length L [mm]	Thread M	Drive	Width across nut SW [mm]	Sales unit [pcs]
STST 6 x 60	504400 ¹⁾	60	M 6	T15	—	100
STST 6 x 80	077714 ¹⁾	80	M 6	T15	—	100
STST 8 x 50	079780 ¹⁾	50	M 8	T25	—	100
STST 8 x 60	079781	60	M 8	T25	6	100
STST 8 x 80	079782	80	M 8	T25	6	100
STST 8 x 100	079783	100	M 8	T25	6	100
STST 8 x 120	079784	120	M 8	T25	6	100
STST 8 x 140	079785	140	M 8	T25	6	50
STST 8 x 180	079786	180	M 8	T25	6	50
STST 10 x 60	077689	60	M 10	T25	8	100
STST 10 x 80	077707	80	M 10	T25	8	100
STST 10 x 100	077708	100	M 10	T25	8	100
STST 10 x 120	077709	120	M 10	T25	8	100
STST 10 x 140	077711	140	M 10	T25	8	50
STST 10 x 180	077712	180	M 10	T25	8	50
STST 12 x 100	535541	100	M 12	T30	10	100
STST 12 x 160	535542	160	M 12	T30	10	50

1) without hex shank

Support hanger AHB

Support hanger AHB for the fixing and height regulation of pipe clamps

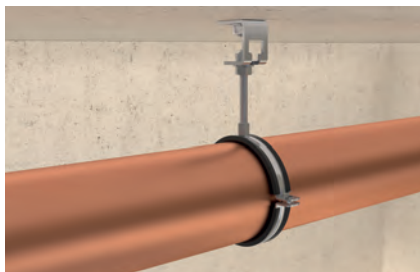

Height adjustable pipe installation

Applications

- Component for height adjustment
- A washer should be used when using size M8 threaded rods
- Use of washer when using threaded rods of size M8

Advantages/benefits

- The seat of the support hanger allows subsequent height regulation at any time.
- The base plate's long slot allows the support hanger to be easily aligned.
- The perforated opening means that a component can be simply hung and adjusted using a threaded rod and nut.

Properties

- Material: steel DD11 (material no. 1.0332) acc. to DIN EN 10111
- Zinc plating: electro zinc-plated, min. 5 µm

2h

Technical data

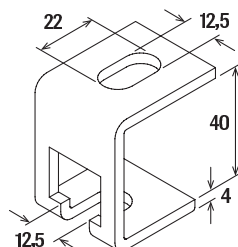

AHB

Item	Item No.	For thread	Max. recom. static load (centr. tension) $N_{\text{recom.}}$ [kN]	Sales unit [pcs]
AHB	079675	M8, M10, M12	1.20	25

Multi connector MW

Multi connector MW for the flexible connection of up to three pipe clamps



Fixation with multi-connector

Applications

- Cube with four threaded drill holes for simple connection
- Ideal for connecting threaded rod and bolts at 90°

Advantages/benefits

- The design of the mounting cube provides flexibility when it comes to connecting pipe clamps or threaded rods.
- The mounting cube allows for the simultaneous fixing of 3 pipelines.

Properties

- Material: diecasting

Technical data

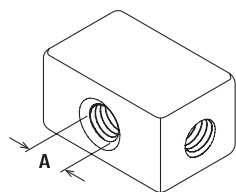

MW

Item	Item No.	Thread A	Max. recom. static load (centr. tension) $N_{recom.}$ [kN]	Sales unit [pcs]
MW M 8	079717	M 8	2.50	50

Parallel connector PV

Parallel connector PV for the easy extension and connection of threaded rods



Longitudinal channel connection

Applications

- Simple, quick-mount connector for extending and connecting threaded rods
- Parallel connector for extending threaded rods
- Secure using locking nut

Advantages/benefits

- The parallel connector's design allows the threaded rods to be installed quickly.
- Designed for simple and fast height adjustment.
- The PV allows the height to be adjusted during installation.

Properties

- Material: diecast

2h

Installation PV

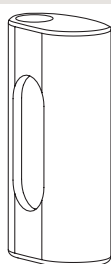
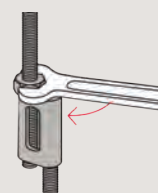

PV

Item	Item No.	For thread	Max. recom. static load (centr. tension) $N_{\text{recom.}}$ [kN]	Sales unit [pcs]
PV M 6	020947	M 6	0.30	100
PV M 8	079678	M 8	2.00	100

Double connector plate DPP, DPF

Base plate - double connector plate for the fixing of two parallel pipelines



Applications

- Fastening element for the installation of two parallel pipelines with just one fastening point

Advantages/benefits

- The double connector plate design saves a fastening point for the fastening of two pipelines.
- The two-part double connector plate DPF is suitable for variable pipe spacing.
- The base plate's long slots allow the double connector plate to be easily aligned.
- The rounded design of the connector plate is ideal for a visual installation.

Properties

- Material DPP: DC04 (material no. 1.0338) acc. to DIN EN 10130
- Material DPF: DC01 (material no. 1.0330) acc. to DIN EN 10130
- Zinc plating: electro zinc-plated, min. 5 µm

Technical data

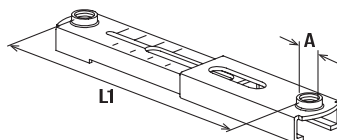
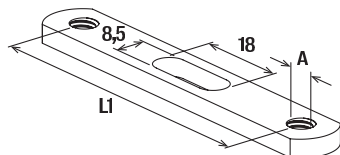

DPP

DPF

Item	Item No.	Length	Thread	Max. recom. static load (centr. tension)	Sales unit
		L ₁ [mm]	A	N _{recom.} [kN]	[pcs]
DPP 65	079702	65	M 8	1.50	50
DPP 85	079703	85	M 8	1.00	50
DPP 105	079704	105	M 8	0.75	50
DPF 60 - 105	024648	60 - 105	M 8	1.5 - 0.5	50

Bolt connector SBB

Technical data



SBB

Item	Item No.	Length L [mm]	Thread A	Sales unit [pcs]
SBB 35	079705	35	M 8	100
SBB 45	079706	45	M 8	100
SBB 55	079707	55	M 8	100

Properties

- Material: steel S235 JR (material no.: 1.0037) acc. to DIN EN 10025
- Zinc plating: electro zinc-plated, min. 8 μm

2h

Turnbuckle SPS, Bolt BLR

Technical data



SPS, BLR

Item	Item No.	Length L [mm]	Thread \emptyset x length [mm]	Max. recom. static load (centr. tension) $N_{\text{recom.}}$ [kN]	Sales unit [pcs]
SPS M 10	537211	125	M 10	10.0	25
BLR 100 M10	537210	100	M 10	10.0	25
SPS M 12	064090	125	M 12	15.00	25
BLR 100 M12	064091	100	M 12	15.00	25

Properties

- Material SPS: steel $\geq 330 \text{ N/mm}^2$ acc. to DIN 1480
- Material BLR: steel acc. to DIN 976, resistance 4.6
- Zinc plating: electro zinc-plated, min. 5 μm

Hexagonal screw SKS

Technical data

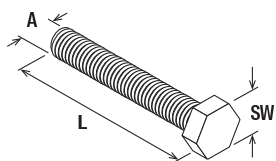

Properties

- Material: steel acc. to DIN-EN-ISO 4017, steel 8.8
- Zinc plating: electro zinc-plated, min. 3 µm

SKS

Item	Item No.	Length L [mm]	Thread A	Width across nut SW [mm]	Sales unit [pcs]
SKS 6 x 20	079711	20	M 6	10	100
SKS 8 x 16	079415	16	M 8	13	100
SKS 8 x 30	079713	30	M 8	13	100
SKS 8 x 45	079714	45	M 8	13	100
SKS 8 x 55	079715	55	M 8	13	100
SKS 8 x 100	079827	100	M 8	13	100
SKS 10 x 20	079416	20	M 10	17	100
SKS 10 x 30	079417	30	M 10	17	100
SKS 10 x 55	079721	55	M 10	17	100
SKS 10 x 65	535537	65	M 10	17	50
SKS 10 x 85	505552	85	M 10	17	100
SKS 12 x 25	535538	25	M 12	19	100
SKS 12 x 55	077611	55	M 12	19	100
SKS 12 x 65	535539	65	M 12	19	50
SKS 12 x 85	505553	85	M 12	19	100

Washer U

Technical data



Properties

- Material: steel acc. to DIN 10139
- Zinc plating: electro zinc-plated, min. 3 µm

U

Item	Item No.	Thickness S [mm]	Hole-Ø D [mm]	External-Ø d [mm]	Sales unit [pcs]
U 6 x 12	544595	1.6	6.4	12	100
U 8 x 17	091477	1.6	8.4	17	100
U 8 x 28	079725	2	8.4	28	100
U 8 x 40	079729	3	8.4	40	100
U 10 x 21	091478	2	10.5	21	100
U 10 x 28	079726	2	10.5	28	100
U 10 x 40	079730	3	10.5	40	100
U 12 x 24	557301	2.5	12.5	24	100
U 12 x 40	024649	3	12.5	40	100
U 16 x 30	557303	3	16.5	30	50
U 16 x 40	535540	3	17	40	50

Hexagonal nut MU

Technical data

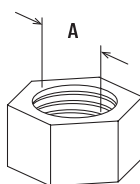

Properties

- Zinc plating: electro zinc-plated, 3 - 8 μm
- Quality: acc. DIN 934, resistance class 8

MU

Item	Item No.	Thread A	Width across nut SW [mm]	Sales unit [pcs]
MU M 6	079733	M 6	10	100
MU M 8	079734	M 8	13	100
MU M 10	079735	M 10	17	100
MU M 12	024650	M 12	19	100
MU M 16	557297	M 16	24	50
MU M 20	535532	M 20	30	15
MU M 24	535534	M 24	36	15

2h

Hexagonal connector VM

Technical data

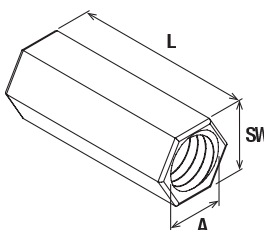

Properties

- Material: C8C (material no. 1.0213) acc. to DIN EN 10263-2
- Zinc plating: electro zinc-plated, 3 - 8 μm

VM

VM

Item	Item No.	Length L [mm]	Thread A	Width across nut SW [mm]	Sales unit [pcs]
VM M 6	014319	25	M 6	10	100
VM M 8	079690	30	M 8	11	100
VM M 10	079691	30	M 10	13	100
VM M 12	020971	40	M 12	17	100
VM M 16	508833	40	M 16	24	50

Eyebolt AG

Technical data

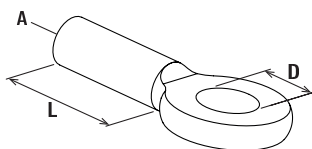

AG

Properties

- Material: steel S235 JR (material no.: 1.0037) acc. to DIN EN 10025
- Zinc plating: electro zinc-plated, 3 - 8 μm

Item	Item No.	Length	Thread	Eye- \emptyset	Max. recom. static load (centr. tension)	Sales unit
		L [mm]	A	D [mm]	$N_{\text{recom.}}$ [kN]	[pcs]
AG 8 x 20	079696	20	M 8	8.5	5.00	100
AG 10 x 25	079697	25	M 10	12.0	8.00	100

Thread hanger RAH

Technical data

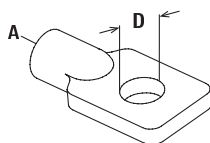

RAH

Properties

- Material: 11SMnPb30 (material no. 1.0718) acc. to DIN EN 10087
- Zinc plating: electro zinc-plated, 3 - 8 μm

Item	Item No.	Thread	Eye- \emptyset	Max. recom. static load (centr. tension)	Sales unit
		A	D [mm]	$N_{\text{recom.}}$ [kN]	[pcs]
RAH M 8	079698	M 8	12.0	4.00	50
RAH M 10	079699	M 10	12.0	4.00	50

Reduction piece RD

Technical data

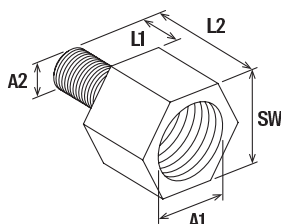

Properties

- Material: 11SMnPb30 (material no. 1.0718) acc. to DIN EN 10087
- Zinc plating: electro zinc-plated, 3 - 8 µm

RD

Item	Item No.	Thread		Length		Width across nut SW [mm]	Sales unit [pcs]
		Internal thread A1	External thread A2	L ₁ [mm]	L ₂ [mm]		
RD M 8 / M 6	020936	M 8	M 6	7	19	13	100
RD M 10 / M 8	079692	M 10	M 8	8	23	13	50
RD M 12 / M 10	079693	M 12	M 10	10	25	17	100
RD M 12 / M 16	504397	M 12	M 16	14	32	19	50
RD M 16 / M 12	504399	M 16	M 12	10	32	24	50
RD 1/2" / M10	079695	1/2"	M 10	10	29	24	10
RD M 16 / M 12 long	538080	M 16	M 12	25	46.5	24	10
RD 1/2" / M10 long	537215	1/2"	M 10	20	39	24	10
RD 3/4" / M 12 long	537213	3/4"	M 12	25	46.5	30	10
RD 3/4" / M 16 long	537214	3/4"	M 16	25	46.5	30	10

2h

Reduction socket RDM and GRD

Technical data



Properties

- Material RDM: SAE 1008
- Material GRD: 11SMnPb30 (material no. 1.0718) acc. to DIN EN 10277
- Zinc plating: electro zinc-plated, 3 - 8 µm

RDM / GRD

Item	Item No.	Thread		Sales unit [pcs]
		A	A2	
RDM M 10 / M 8	079413	M 8	M 10	50
RDM M 12 / M 10	079414	M 10	M 12	100
GRD 1/2" / M 10	077609	1/2"	M 10	100
GRD 1/2" / M 12	077608	1/2"	M 12	100
GRD 3/4" / M 10	077607	3/4"	M 10	100
GRD 3/4" / M 12	077606	3/4"	M 12	100

Flat eye screw LLS

Technical data



LLS

Item	Item No.	Length L [mm]	Thread [mm]	Eye-Ø D [mm]	Sales unit [pcs]
LLS 6 x 50	079700	50	6	8.5	100
LLS 8 x 50	079701	50	8	10.5	100

Properties

- Material: steel S235 JR (material no.: 1.0037) acc. to DIN EN 10025
- Zinc plating: electro zinc-plated, 3 - 8 µm

2h

Textile web strapping GWB

Perforated steel banding LBV / LBK for the fast fixing of pipelines



Flexible and rigid plastic insulation pipes

Applications

- Pipelines
- Flexible and rigid plastic pipes
- Compound pipes

Advantages/benefits

- Pipe fastening using textile tape allows cheap and simple installation.
- The textile tape roll allows the correct tape length to be chosen to suit the

- diameter in question.
- Hangings with textile tape are a fast solution for temporary fixings.

Properties

- Material: polypropylene

Installation GWB

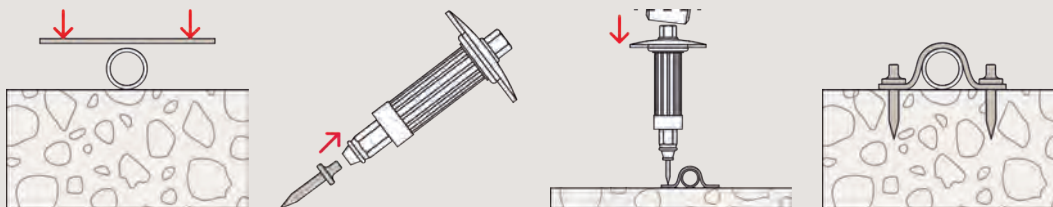

Technical data

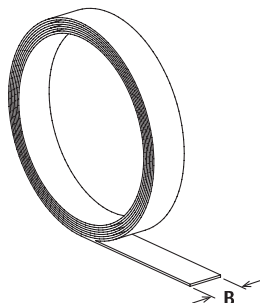

GWB

Item	Item No.	Total length l [mm]	Width B [mm]	Thickness S [mm]	Sales unit [pcs]
GWB	020959	10000	15	1.1	10

Perforated steel banding LBV/LBK

Perforated steel banding LBV / LBK for the fast fixing of pipelines



Plastic pipes

2h

Applications

- Steel tape with stamped holes for simple installation; available zinc-plated LBV or plastic-covered LKB
- The fischer nail anchor FNA II is suitable for ceiling fixing in concrete
- Use fischer thread hanger RAH for fastening to threaded rods

Advantages/benefits

- The perforated tape's material thicknesses and plastic covering allows the tapes to be easily cut to size using metal shears.
- The perforated tape's hole geometry enables concrete fixing using the fischer impact nail ED.

Properties

- Material: DX51D+Z 100 (material no. 1.0917) acc. to DIN EN 10.346 For Type LBW17: Q235
- Zinc plating: electro zinc-plated, min. 5 µm
- Protective coating LBK: PE

Installation LBV/LBK

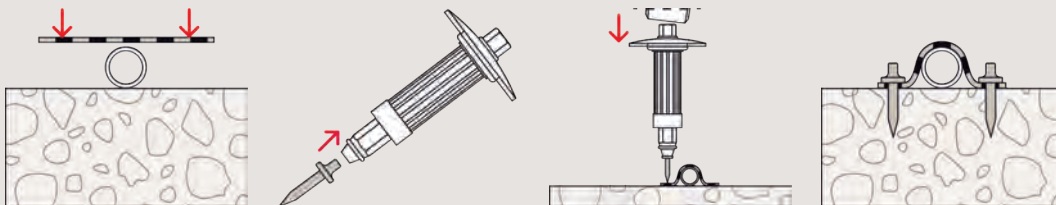

Technical data

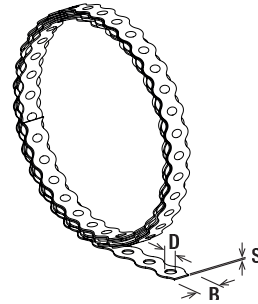
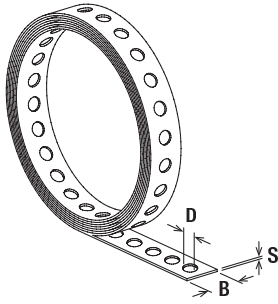

LBV/LBK

LBW

Item	Item No.	Total length l [mm]	Width B [mm]	Thickness S [mm]	Eye-Ø D [mm]	Sales unit [pcs]
LBV 12	079549	10000	12	0.75	5	10
LBV 17	079550	10000	17	0.75	6.5	10
LBV 25	079551	10000	25	0.88	8.5	8
LBK 14	079553	10000	14	2.6	5	10
LBK 19	079554	10000	19	2.4	6.5	8
LBK 27	079555	10000	27	2.4	8.5	5
LBW 17	507435	10000	27	0.87	7	10

2h

Impact nail ED

Fixing in concrete without pre-drilling



Fixing armoured conduits



Fixing perforated tapes

Applications

2h

For fixing of:

- Conduit clips such as BSM, BSMD, BSMZ
- Perforated band such as LBK, LBV

Advantages

- The stable impact nail ED can be set in concrete with the impact nail setting tool SZE without pre-drilling. This allows for a fast installation.
- The setting tool SZE impact protection provides the best protection for your hand, thus ensuring a safe installation.

Installation ED

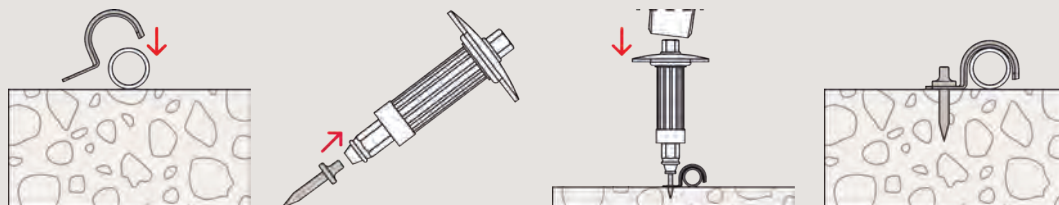

Technical data

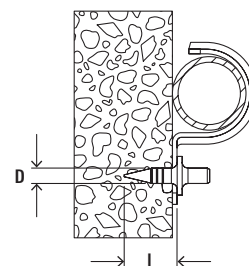

ED

Item	Item No.	Length L [mm]	Diameter d [mm]	Sales unit [pcs]
ED 15	048212	15	4.0	200
ED 18	079815	18	4.0	200
ED 22	014570	22	4.0	200

Technical data



SZE

Toolset for SZE

Item	Item No.	Sales unit [pcs]
SZE	552149	1
Toolset for SZE	552150	3

2h

Beam clamp FHBC

FHBC Beam clamp - Beam clamp for the installation of FUS channels on steel girders



Pipe installation on steel girders

Applications

- For installing FUS profile channels between the flanges on steel girders and U-profiles
- Suitable for FUS channels FUS 41
- For indoor and outdoor applications and in environments with high stress to components due to corrosion

Advantages/benefits

- Easy installation of FUS profile to the flanges of steel girders.
- The FHBC allows for the installation of FUS channels on steel girders without drilling.
- The surface coating creates a high corrosion protection against environmental influences like humidity, water, saltwater or other corrosive substances

Properties

- Material: steel S235 JR (material no.: 1.0037) acc. to DIN EN 10025 (74074882)
- Zinc plating: hot-dip galvanised, min. 45 µm, acc. to DIN EN ISO 1461 (74083471)

2h

Installation FHBC

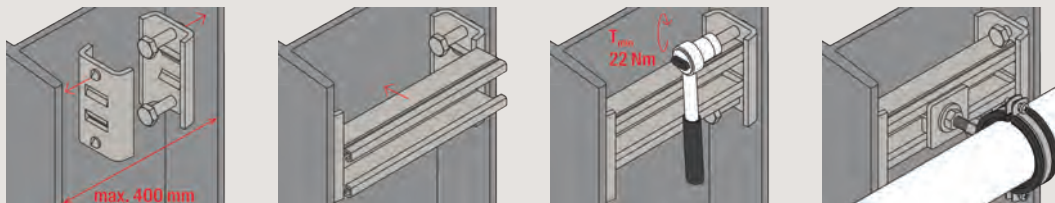

Technical data / Loads

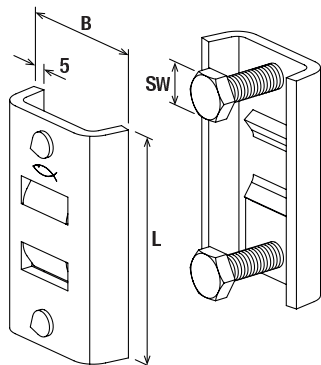

FHBC

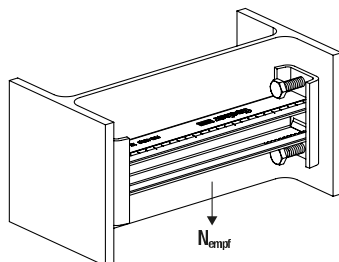

Load FHBC

Item	Item No.	Width B [mm]	Length L [mm]	Drive	Max. recom. static load (centr. tension) N _{recom.} [kN]	Tightening torque T _{inst} [Nm]	Sales unit [pcs]
FHBC	557375	55	90	SW 17	3.6	22	10

































3a

3a

Channel system

FUS hdg.

Pipe clamp FRS zl	228		Connector FCN Clix P hdg. / FCN Clix M hdg.	258	
Heavy duty pipe clamp FRSM hdg. - metric	230		Channel washer HK 41 hdg.	260	
Channel FUS hdg.	232		Saddle flange SF hdg.	261	
Channel connector FUF OC hdg. and PFUF OC zl	237		Mounting bracket UWS hdg.	262	
Cantilever arm FCA hdg.	238		Angle bracket WK hdg.	263	
Large cantilever arm FCAM hdg.	241		Threaded rod bracket FSB 45° hdg.	266	
Push-through connector PFCN 41 zl	244		Beam clamp TKR hdg.	267	
Saddle flange PSF zl	246		Bracket FFF hdg.	269	
Universal bracket PUWS zl	248		Bracket FAF hdg.	270	
Angle bracket PWK zl	249		Flanges FUF hdg.	271	
Variable bracket PVB zl	250		Flanges FUF hdg.	272	
Bracing elements PSAE zl	251		Threaded rod G hdg.	273	
Bracket PFFF zl	253		Washer U mz	273	
Bracket PFAF zl	254		Hexagonal nut MU hdg.	274	
Bracket PFUF zl	256		Hexagonal screw SKS hdg.	274	
Brackets PFUF D zl	257		Channel connector FDCC zl	275	

3a

Pipe clamp FRS zl

FRS zl pipe clamp with high corrosion protection

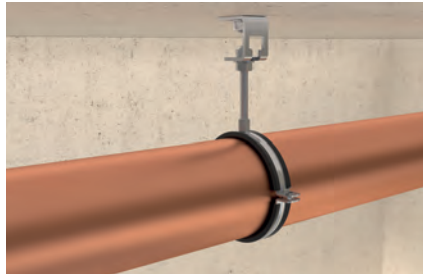

Height adjustable pipe installation

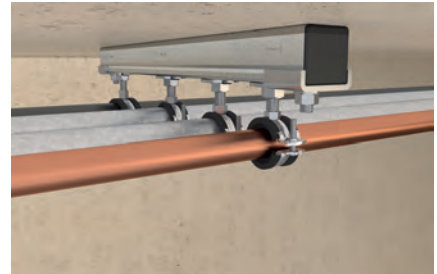

Drainage pipe assembly

Applications

- Secure fixing for pipes with threaded rods or stud screws (also when there are fire protection requirements)
- For indoor and outdoor applications and in environments with high stress to components due to corrosion

Certificates



Fire resistance classification
R120



MLAR R30

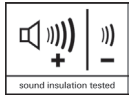

sound insulation tested

Advantages/benefits

- The fire test report guarantees independently tested functional safety.
- The two screws allow an easy adjustment to suit the outer pipe diameter.
- The combination connecting nut with thread M8/M10 enables optimised mounting choices.
- The sound insulation insert offers noise protection and prevents contact corrosion.
- The screw's safety feature ensures trouble-free installation.
- The surface coating creates a high corrosion protection against environmental influences like humidity, water, saltwater or other corrosive substances.

Properties

- Material: steel DC01 (material no. 1.0330) acc. to DIN EN 10130
- Coating: Zinclamella acc. to DIN EN ISO 10683 or 13858, min. 15 µm
- Connecting nut: resistance welded, M8 / M10, SW 13
- Locking screw: flat head screw with combination recessed head
- Material sound insulation insert: EPDM; chlorine-free; silicone-free
- Sound insulation: for DIN 4109
- Temperature range: -40 °C to +100 °C
- Hardness: 55 ± 5° Shore A
- Fire behaviour: DIN 4102: Class B2

Installation FRS

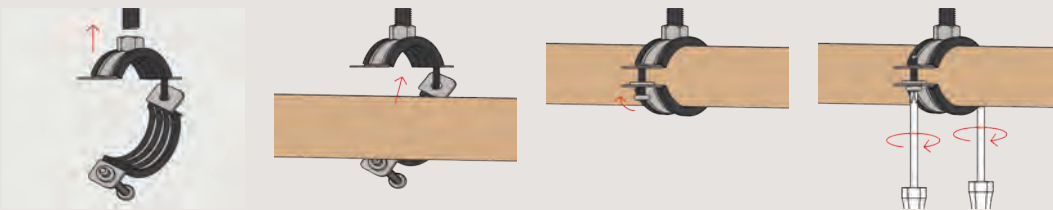

Technical data

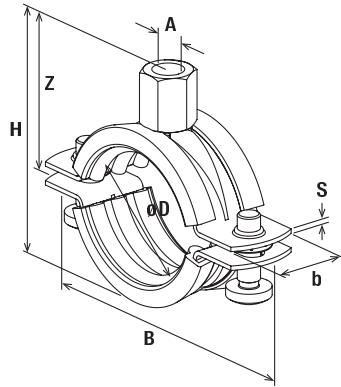

FRS M8/M10

Item	Item No.	Fire test report	Thread A	Size [inch]	Clamp- ing range D [mm]	Width B [mm]	Height H [mm]	Width x thick- ness clamp band b x s [mm]	Height Z Z [mm]	Locking screw	Max. recom. static load (centr. tension) $N_{recom.}$ [kN]	Sales unit [pcs]
FRS 12 - 15 M8/M10 hdg	537981	X	M 8 / M 10	1/4"	12 - 15	55	39	20 x 1.25	31	M 6	1.00	100
FRS 15 - 19 M8/M10 hdg	537982	X	M 8 / M 10	3/8"	15 - 19	59	43	20 x 1.25	29	M 6	1.00	100
FRS 20 - 24 M8/M10 hdg	537983	X	M 8 / M 10	1/2"	20 - 24	65	48	20 x 1.25	32	M 6	1.00	100
FRS 25 - 30 M8/M10 hdg	537984	X	M 8 / M 10	3/4"	25 - 30	72	54	20 x 1.25	35	M 6	1.00	100
FRS 32 - 37 M8/M10 hdg	537985	X	M 8 / M 10	1"	32 - 37	77	61	20 x 1.25	38	M 6	1.00	100
FRS 40 - 45 M8/M10 hdg	537986	X	M 8 / M 10	1 1/4"	40 - 45	89	69	20 x 1.25	42	M 6	1.00	50
FRS 48 - 54 M8/M10 hdg	537987	X	M 8 / M 10	1 1/2"	48 - 54	99	78	20 x 1.25	46	M 6	1.00	50
FRS 55 - 61 M8/M10 hdg	537988	X	M 8 / M 10	2"	55 - 61	105	85	20 x 1.25	50	M 6	1.00	50
FRS 63 - 67 M8/M10 hdg	537989	X	M 8 / M 10	—	63 - 67	111	91	20 x 1.25	53	M 6	1.00	50
FRS 72 - 80 M8/M10 hdg	537990	X	M 8 / M 10	2 1/2"	72 - 80	125	104	20 x 2.0	60	M 6	1.50	25
FRS 87 - 92 M8/M10 hdg	537991	X	M 8 / M 10	3"	87 - 92	137	116	20 x 2.0	66	M 6	1.50	25
FRS 95 - 103 M8/M10 hdg	557374	X	M 8 / M 10	—	95 - 103	149	130	25 x 2,0	73	M 6	2.00	25
FRS 108 - 116 M8/M10 hdg	537992	X	M 8 / M 10	4"	108 - 116	164	140	25 x 2,0	78	M 6	2.00	20
FRS 121 - 128 M8/M10 hdg	537993	X	M 8 / M 10	—	121 - 128	176	152	25 x 2.5	84	M 6	2.50	10
FRS 133 - 141 M8/M10 hdg	537994	X	M 8 / M 10	5"	133 - 141	187	165	25 x 2.5	90	M 6	2.50	10
FRS 159 - 165 M8/M10 hdg	537995	X	M 8 / M 10	—	159 - 165	211	198	25 x 2.5	102	M 6	2.50	8
FRS 165 - 168 M8/M10 hdg	537996	X	M 8 / M 10	6"	165 - 168	225	192	25 x 2.5	104	M 6	2.50	8

3a

Heavy duty pipe clamp FRSM hdg. - metric

The large pipe clamp with sound insulation insert for medium to heavy loads



Heavy pipe on cantilever

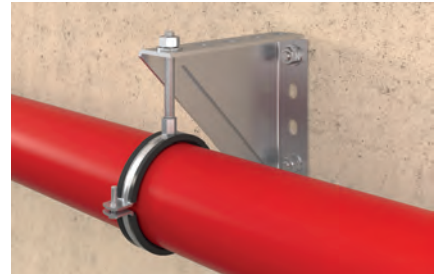

Heavy drainage pipe under angle bracket

Applications

- Fixing of medium to heavy pipes with threaded rods (hanger bolts)
- For indoor and outdoor applications and in environments with high stress to components due to corrosion

Advantages/benefits

- High tested loads guarantee safe functioning of the FRSM.
- The combination connecting nut with thread M10/M12, M12/M16 or M16 allows for optimised mounting choices.
- From \varnothing 124 mm it is possible to install with 2 threaded rods, e.g. for the fixing of cast iron roof drainage pipes.
- The two screws allow for easy adjustment to suit the outer pipe diameter.
- The screw's safety features ensures trouble-free installation.
- The surface coating enables a high corrosion protection against humidity, water, salt water, and other corrosive materials.

Properties

- Material: steel DD11 (material no. 1.0332) acc. to DIN EN 10111
- Zinc plating: hot-dip galvanised, min. 45 μm , acc. to DIN EN ISO 1461
- Connecting nut: M10 / M12 = SW 17, M12 / M16 = SW 22, M16 = SW 24
- Locking screw: hexagon screw with nut
- Material sound insulation insert: EPDM; chlorine-free; silicone-free
- Temperature range: $-50\text{ }^{\circ}\text{C}$ to $+110\text{ }^{\circ}\text{C}$
- Hardness: $45 \pm 5^{\circ}$ Shore A
- Fire behaviour: DIN 4102: Class B2

Installation FRSM hdg.

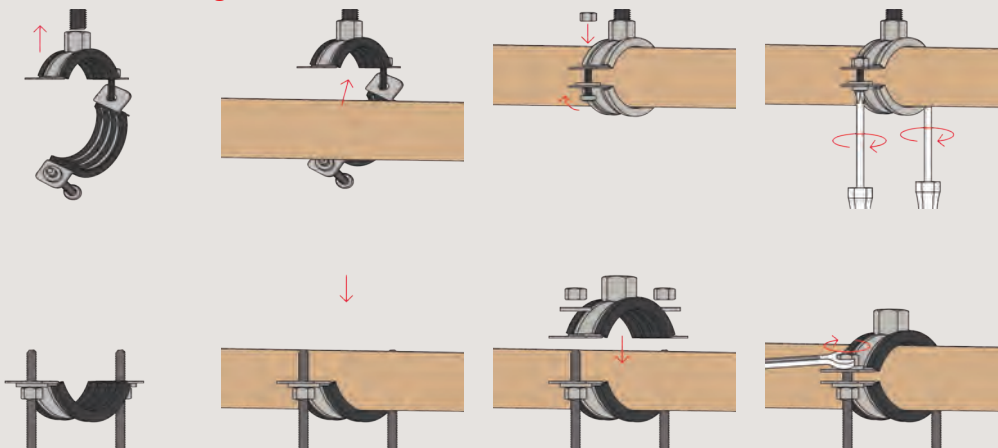

Technical data

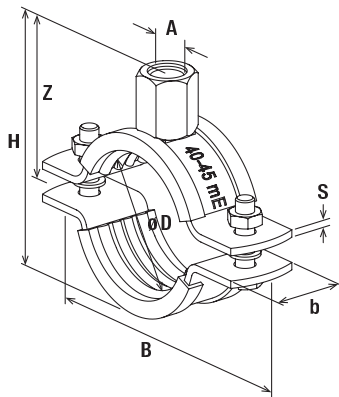

FRSM hdg. - metric

Item	Item No.	Thread	Size	Clamping range	Width	Height	Width x thickness clamp band	Height Z	Locking screw	Max. recom. static load (centr. tension) N _{recom.} [kN]	Sales unit [pcs]
		A	[inch]	D [mm]	B [mm]	H [mm]	b x s [mm]	Z [mm]			
FRSM 1/2" M10/M12 hdg.	558524	M 10 / M 12	1/2"	19 - 23	77	56	25 x 2.5	38	M 6	2.50	50
FRSM 3/4" M10/M12 hdg.	558525	M 10 / M 12	3/4"	24 - 29	83	62	25 x 2.5	41	M 6	2.50	50
FRSM 1" M10/M12 hdg.	558526	M 10 / M 12	1"	33 - 36	91	69	25 x 2.5	45	M 6	2.50	50
FRSM 1 1/4" M10/M12 hdg.	558527	M 10 / M 12	1 1/4"	40 - 45	100	78	25 x 2.5	49	M 6	2.50	20
FRSM 1 1/2" M10/M12 hdg.	558528	M 10 / M 12	1 1/2"	48 - 52	107	85	25 x 2.5	53	M 6	2.50	20
FRSM 53-58 M10/M12 hdg.	558529	M 10 / M 12	—	53 - 58	113	91	25 x 2.5	56	M 6	2.50	20
FRSM 2" M10/M12 hdg.	558530	M 10 / M 12	2"	60 - 65	120	98	25 x 2.5	59	M 6	2.50	20
FRSM 2 1/2" M10/M12 hdg.	558531	M 10 / M 12	2 1/2"	73 - 78	138	115	30 x 3,0	68	M 8	3.00	20
FRSM 79-85 M10/M12 hdg.	558532	M 10 / M 12	—	79 - 85	145	122	30 x 3,0	71	M 8	3.00	20
FRSM 3" M10/M12 hdg.	558533	M 10 / M 12	3"	88 - 93	153	130	30 x 3,0	75	M 8	3.00	20
FRSM 102" M10/M12 hdg.	558534	M 10 / M 12	—	100 - 106	166	143	30 x 3,0	82	M 8	3.00	20
FRSM 4" M10/M12 hdg.	558606	M 10 / M 12	4"	108 - 116	176	153	30 x 3,0	87	M 8	3.00	20
FRSM 124-129 M10/M12 hdg.	558535	M 10 / M 12	—	124 - 129	194	165	30 x 3,0	97	M 8	3.00	20
FRSM 131-137" M10/M12 hdg.	558536	M 10 / M 12	—	131 - 137	202	173	30 x 3,0	100	M 8	3.00	20
FRSM 138-145 M10/M12 hdg.	558537	M 10 / M 12	5"	138 - 145	210	180	30 x 3,0	109	M 8	3.00	20
FRSM 156-162 M10/M12 hdg.	558538	M 10 / M 12	—	156 - 162	227	198	30 x 3,0	114	M 8	3.00	20
FRSM 165-171 M10/M12 hdg.	558539	M 10 / M 12	6"	165 - 171	255	207	30 x 3,0	125	M 8	3.00	20
FRSM 188-194 M10/M12 hdg.	558540	M 10 / M 12	7"	188 - 194	278	230	30 x 3,0	125	M 8	3.00	10
FRSM 196-203 M10/M12 hdg.	558541	M 10 / M 12	—	196 - 203	287	239	30 x 3,0	130	M 8	3.00	10
FRSM 212 M12/M16 hdg.	558542	M 12 / M 16	—	205 - 214	289	264	40 x 4,0	147	M 12	5.00	10
FRSM 8" M12/M16 hdg.	558543	M 12 / M 16	8"	219 - 225	300	272	40 x 4,0	152	M 12	5.00	10
FRSM 250 M12/M16 hdg.	558544	M 12 / M 16	—	244 - 250	325	300	40 x 4,0	165	M 12	5.00	10
FRSM 10" M12/M16 hdg.	558545	M 12 / M 16	10"	267 - 273	348	323	40 x 4,0	177	M 12	5.00	10
FRSM 300 M12/M16 hdg.	558546	M 12 / M 16	—	297 - 304	379	354	40 x 4,0	192	M 12	5.00	10
FRSM 305-316 M12/M16 hdg.	558547	M 12 / M 16	—	305 - 316	397	314	40 x 4,0	157	M 12	5.00	10
FRSM 12" M12/M16 hdg.	558548	M 12 / M 16	12"	320 - 328	403	378	40 x 4,0	204	M 12	5.00	10
FRSM 348-356 M16 hdg.	558549	M 16	—	348 - 356	480	403	50 x 5,0	213	M 16	8.00	1
FRSM 364-372 M16 hdg.	558596	M 16	—	364 - 372	496	419	50 x 5,0	221	M 16	8.00	1
FRSM 400-409 M16 hdg.	558597	M 16	—	400 - 409	533	456	50 x 5,0	240	M 16	8.00	1
FRSM 454-462 M16 hdg.	558598	M 16	—	454 - 462	586	509	50 x 5,0	266	M 16	8.00	1
FRSM 500-508 M16 hdg.	558599	M 16	—	500 - 508	632	555	50 x 5,0	290	M 16	8.00	1

3a

Channel FUS hdg.

The universal and complete mounting channel system for a wide range of applications



3D-frame constructions



Solid frame construction

Applications

- Creation of secure, horizontal and vertical installations
- Fast and efficient fixing of pipelines and supporting structures
- For indoor and outdoor applications and in environments with high stress to components due to corrosion

Certificates



Fire resistance classification
R120



MLAR R30

Advantages/benefits

- The fire inspection report in line with MLAR/EN13501 guarantees independently tested functional safety.
- The basic channel geometry allows for the usage of the complete extensive range of accessories.
- The stamped teeth in the channel gives the sliding nuts a secure hold for high shear loads, e.g. for vertical installation.
- Different channel wall thicknesses allow for economical choices for installation.
- The scale on the mounting channels simplifies the cutting and positioning of the fixtures during installation.
- The surface coating creates a high corrosion protection against environmental influences like humidity, water, saltwater or other corrosive substances.

Properties

- Material: steel S235 JR (material no.: 1.0037) acc. to DIN EN 10025
- Zinc plating: hot-dip galvanised, min. 45 µm, acc. to DIN EN ISO 1461

Technical data

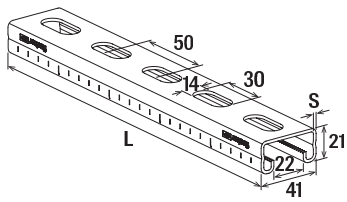

FUS 21

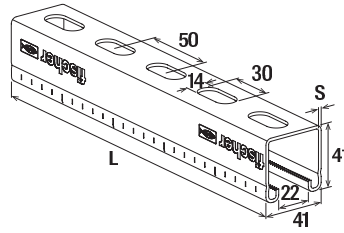

FUS 41

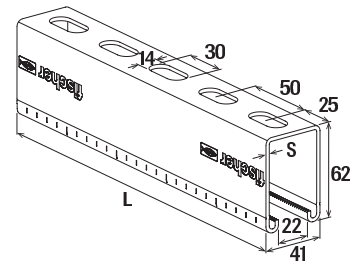

FUS 62

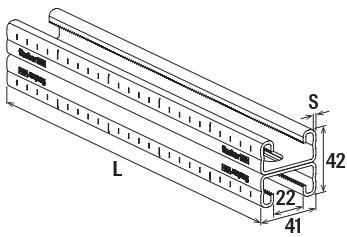

FUS 21D

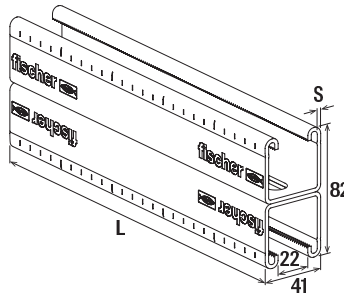

FUS 41D

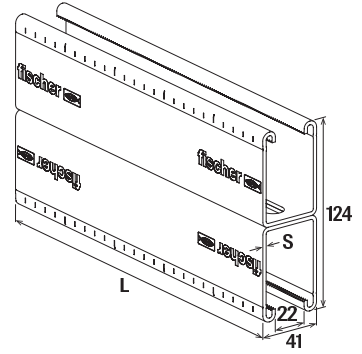

FUS 62D

3a

Item	Item No.	Fire test report	Length L [mm]	Thickness S [mm]	Sales unit [pcs]
FUS 21/2,0 - 3 m hdg.	537653	—	3000	2.0	1
FUS 41/2,0 - 3 m hdg.	517426	—	3000	2.0	1
FUS 41/2,0 - 6 m hdg.	537656	—	6000	2.0	1
FUS 41/2,5 - 6 m hdg.	537658	X	6000	2.5	1
FUS 62/2,5 - 3 m hdg.	517427	X	3000	2.5	1
FUS 62/2,5 - 6 m hdg.	517428	X	6000	2.5	1
FUS 21D/2,0 - 3 m hdg.	537659	—	3000	2.0	1
FUS 21D/2,0 - 6 m hdg.	537661	—	6000	2.0	1
FUS 41D/2,5 - 6 m hdg.	537662	—	6000	2.5	1
FUS 62D/2,5 - 6 m hdg.	537663	—	6000	2.5	1

Loads

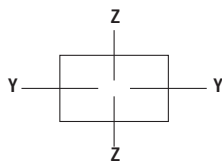

Item	Item No.	Profil weight [kg/m]	Profile cross section [cm ²]	Moment of inertia I _y [cm ⁴]	Moment of inertia I _z [cm ⁴]	Section modulus W _y [cm ³]	Section modulus W _z [cm ³]	Max. rec-ommended static load for 1m length F _{rec} [kN]	Max. rec-ommended static load for 2m length F _{rec} [kN]	Max. rec-ommended static load for 3m length F _{rec} [kN]
FUS 21/2,0 - 3 m hdg.	537653	1.44	1.72	0.97	4.66	0.89	2.27	0.49	0.12	0.05
FUS 41/2,0 - 3 m hdg.	517426	2.06	2.52	5.33	7.69	2.58	3.75	1.94	0.67	0.30
FUS 41/2,0 - 6 m hdg.	537656	2.06	2.52	5.33	7.69	2.58	3.75	1.94	0.67	0.30
FUS 41/2,5 - 6 m hdg.	537658	2.45	3.00	6.00	8.99	2.85	4.38	2.14	0.76	0.34
FUS 62/2,5 - 3 m hdg.	517427	3.27	4.05	17.70	12.90	5.62	6.29	4.22	2.10	0.99
FUS 62/2,5 - 6 m hdg.	517428	3.27	4.05	17.70	12.90	5.62	6.29	4.22	2.10	0.99

Loads

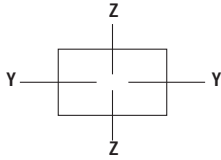

Item	Item No.	Profil weight [kg/m]	Profile cross section [cm ²]	Moment of inertia I_y [cm ⁴]	Moment of inertia I_z [cm ⁴]	Section modulus W_y [cm ³]	Section modulus W_z [cm ³]	Max. recommended static load for 1m length F_{rec} [kN]	Max. recommended static load for 2m length F_{rec} [kN]	Max. recommended static load for 3m length F_{rec} [kN]
FUS 21D/2,0 - 3 m hdg.	537659	2.87	3.44	5.49	9.31	2.61	4.54	1.96	0.69	0.31
FUS 21D/2,0 - 6 m hdg.	537661	2.87	3.44	5.49	9.31	2.61	4.54	1.96	0.69	0.31
FUS 41D/2,5 - 6 m hdg.	537662	4.89	6.00	35.01	17.90	8.76	8.78	6.58	3.28	1.96
FUS 62D/2,5 - 6 m hdg.	537663	6.55	8.09	111.00	25.80	17.90	12.58	13.45	6.72	4.47

3a

Load case 1

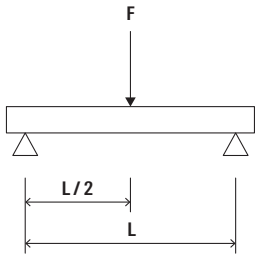

Load case 2

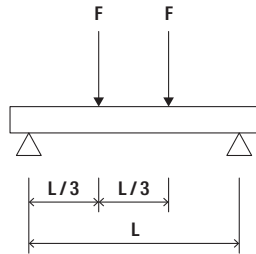

Load case 3

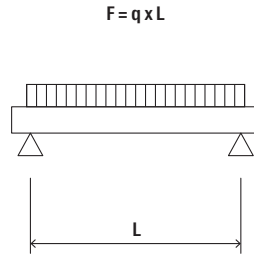

FUS 21/2,0

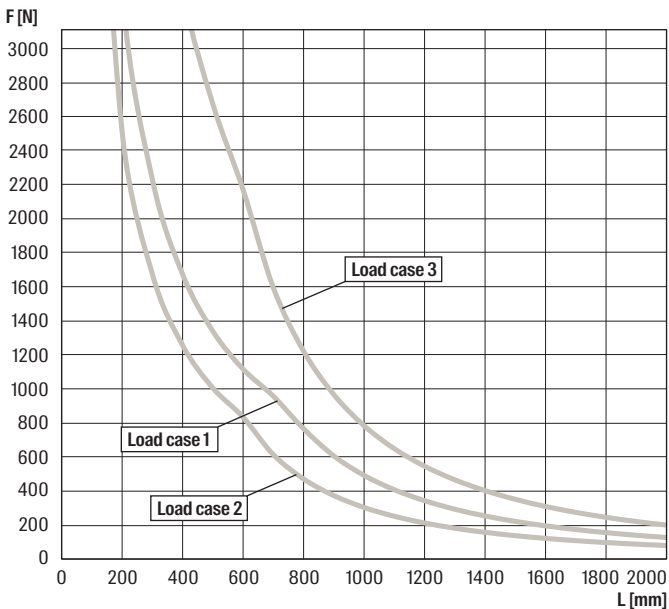

FUS 41/2,0

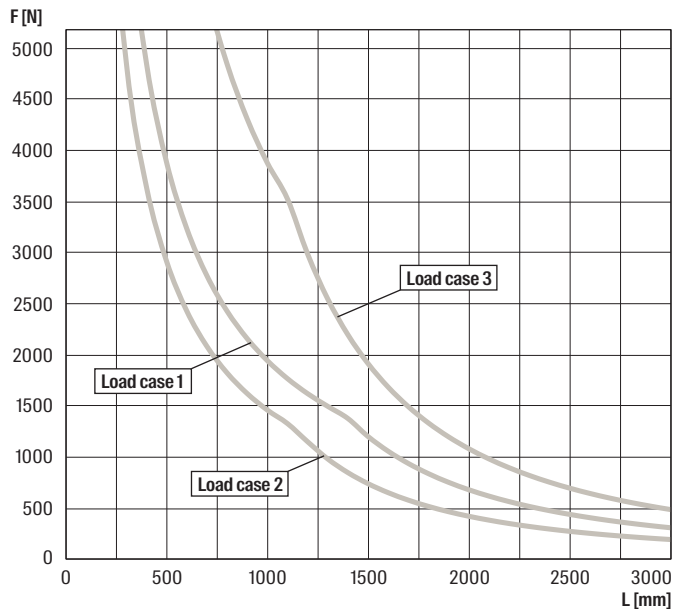

For the load curves, the permissible steel strain $\delta_{adm.} = 188$ N/mm and the maximum deflection under load $L/200$ are not exceeded. Fixings and screw fastenings must be calculated accordingly. The increased yield strength is calculated according to DIN EN 1993-1-3:2010-12, sec. 3.2.2.

FUS 41/2,5

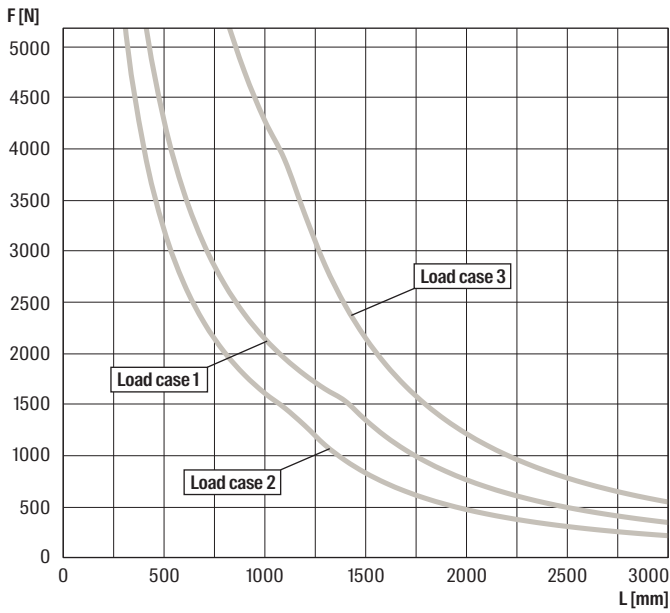

FUS 62/2,5

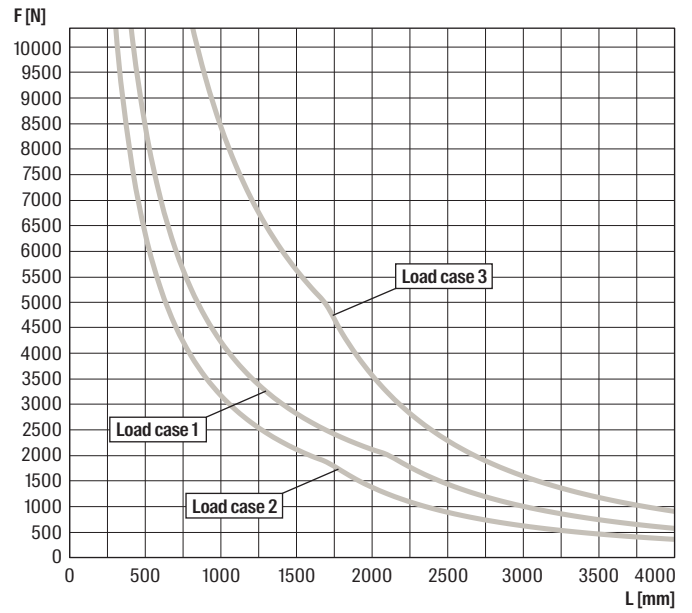

For the load curves, the permissible steel strain $\delta_{adm.} = 188 \text{ N/mm}$ and the maximum deflection under load $L/200$ are not exceeded. Fixings and screw fastenings must be calculated accordingly. The increased yield strength is calculated according DIN EN 1993-1-3:2010-12, sec. 3.2.2.

3a

FUS 21D/2,0

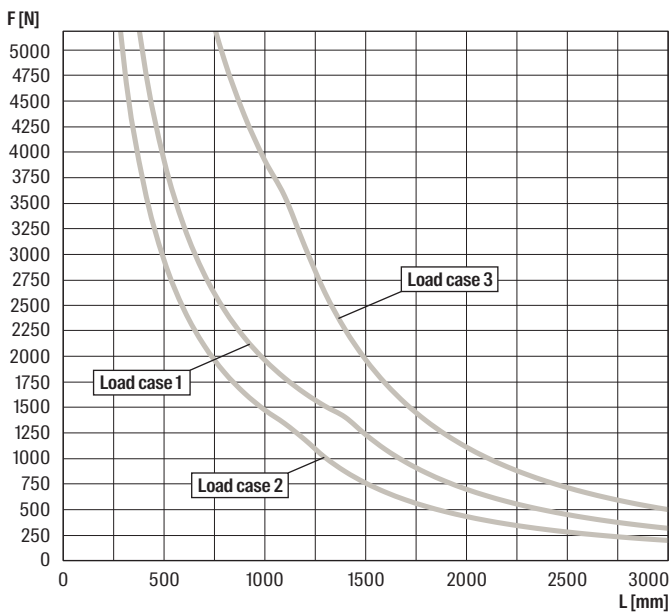

FUS 41D/2,5

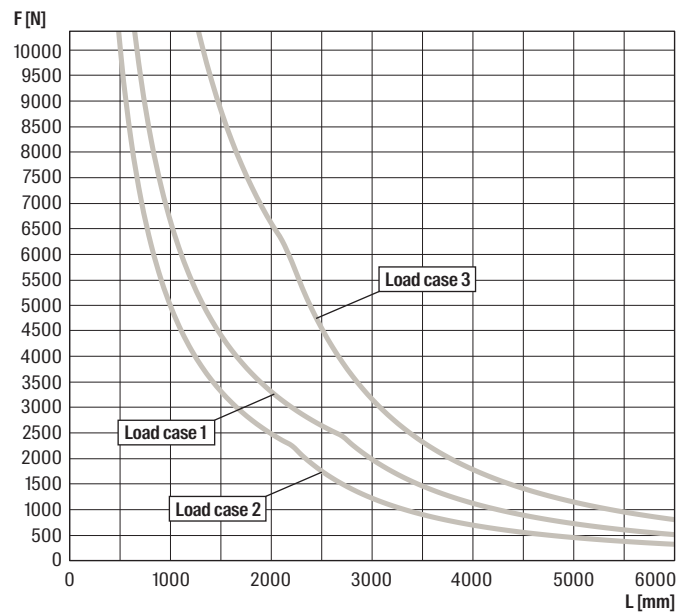

For the load curves, the permissible steel strain $\delta_{adm.} = 188 \text{ N/mm}$ and the maximum deflection under load $L/200$ are not exceeded. Fixings and screw fastenings must be calculated accordingly. The increased yield strength is calculated according DIN EN 1993-1-3:2010-12, sec. 3.2.2.

FUS 62D/2,5

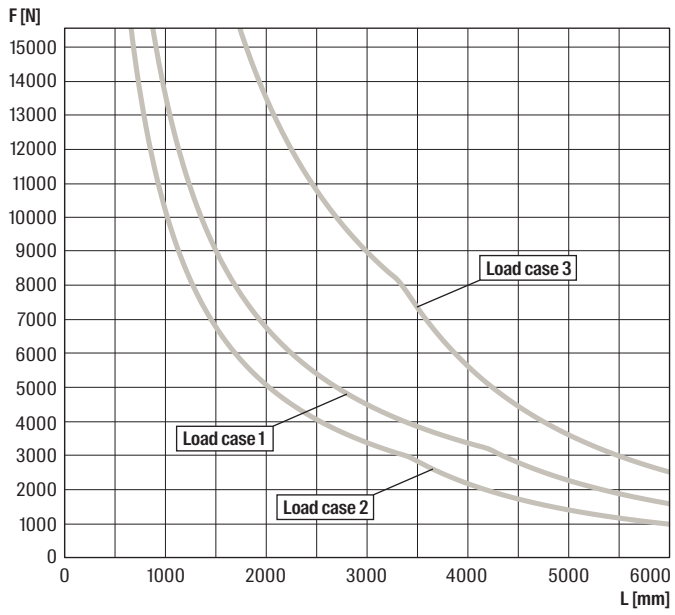

3a For the load curves, the permissible steel strain $\delta_{adm.} = 188$ N/mm and the maximum deflection under load $L/200$ are not exceeded. Fixings and screw fastenings must be calculated accordingly. The increased yield strength is calculated according DIN EN 1993-1-3:2010-12, sec. 3.2.2.

Channel connector FUF OC hdg.

Construction element - Channel connector FUF OC hdg.



Connector for installation grid



Longitudinal channel connection

Applications

- Connection and alignment of the channels
- For indoor and outdoor applications and in environments with high stress to components due to corrosion

Advantages/benefits

- The FUF OC connector in combination with FCN Clix P allows a simple and time-saving installation.
- The PFUF OC connector in combination with PFCN allows a simple and time-saving installation.
- The surface coating creates a high corrosion protection against environmental influences like humidity, water, saltwater or other corrosive substances.

Properties

- Material FUF OC: steel S235 JR (material no. 1.0037) acc. to DIN EN 10025
- Zinc plating FUF OC: hot-dip galvanised, min. 45 µm, acc. to DIN EN ISO 1461

3a

Technical data

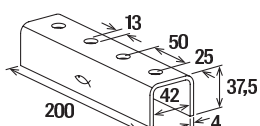

FUF OC 41

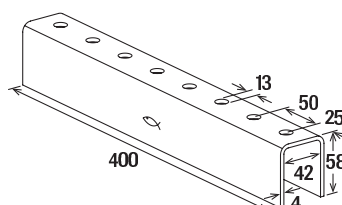

FUF OC 62

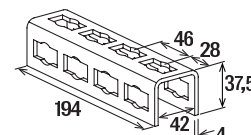

PFUF OC zl

Item	Item No.	Length L [mm]	Sales unit [pcs]
FUF OC 41 hdg.	517415	200	20
FUF OC 62 hdg.	537591	400	10
PFUF OC zl	542719	194	6

Cantilever arm FCA hdg.

Hot-dip galvanised FUS profiles with welded base plate for direct mounting on the base material

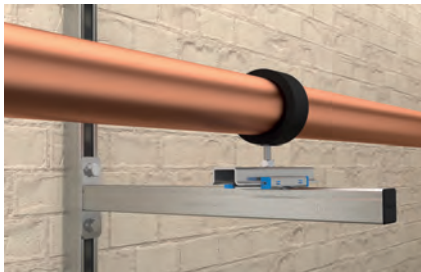

Refrigerant pipe clamp on sliding element



Heavy pipe on cantilever

Applications

- Quick and easy installation of pipelines, for example, along the wall
- For indoor and outdoor applications and in environments with high stress to components due to corrosion

Certificates



Fire resistance classification
R120



MLAR R30

Advantages/benefits

- The fire inspection report in line with MLAR/EN13501 guarantees independently tested functional safety.
- The graduated range of lengths allows for an ideal adaptation to the application.
- The arms solid base plate offers a secure hold for load-bearing construction.
- The base plate's long slots, which are at 90° to one another, allow the arm to be easily aligned.
- The stamped teeth in the channel give the sliding nuts a secure hold for high shear loads, e.g. for vertical installation.
- The surface coating creates a high corrosion protection against environmental influences like humidity, water, saltwater or other corrosive substances.

Properties

- Material: steel S235 JR (material no.10037) acc. to DIN EN 10025
- Zinc plating: hot-dip galvanised, min. 45 µm, acc. to DIN EN ISO 1461

Technical data

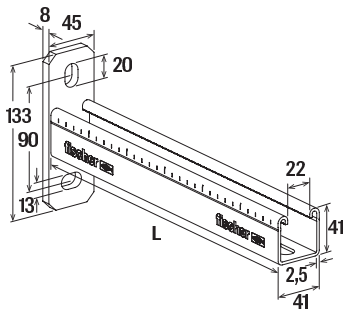

FCA 41

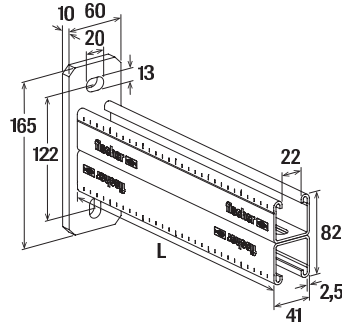

FCA 41D

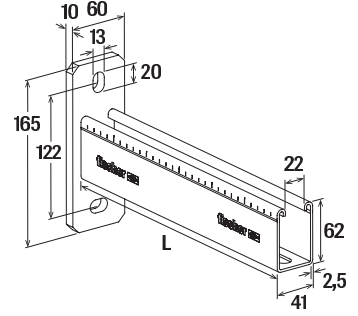

FCA 62

Item	Item No.	Fire test report	Profile	Length L [mm]	Sales unit [pcs]
FCA 41 - 300 hdg.	517411	X	41/2,5	300	1
FCA 41 - 450 hdg.	517412	X	41/2,5	450	1
FCA 41 - 600 hdg.	517413	X	41/2,5	600	1
FCA 41 - 750 hdg.	517414	X	41/2,5	750	1
FCA 62 - 1000 hdg.	538015	X	62/2,5	1000	1
FCA 41D - 750 hdg.	538016	—	41D/2,5	750	1
FCA 41D - 1000 hdg.	538017	—	41D/2,5	1000	1

3a

Loads

Item	Item No.	Max. recommended static load load case 1	Max. recommended static load load case 2	Max. recommended static load load case 3
		F_{rec} [kN]	F_{rec} [kN]	F_{rec} [kN]
FCA 41 - 300 hdg.	517411	1.8	0.9	1.8
FCA 41 - 450 hdg.	517412	1.2	0.6	1.2
FCA 41 - 600 hdg.	517413	0.9	0.45	0.9
FCA 41 - 750 hdg.	517414	0.72	0.36	0.72
FCA 62 - 1000 hdg.	538015	1.25	0.62	1.25
FCA 41D - 750 hdg.	538016	2.5	1.25	2.5
FCA 41D - 1000 hdg.	538017	1.9	0.93	1.9

Load case 1

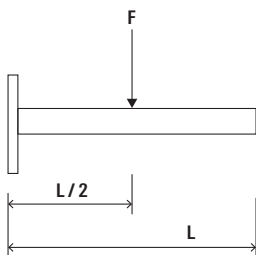

Load case 2

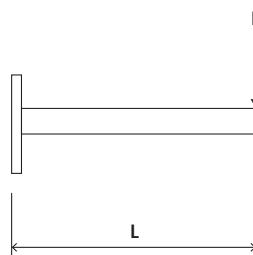

Load case 3

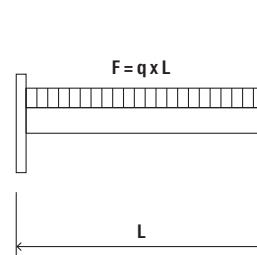

FCA 41

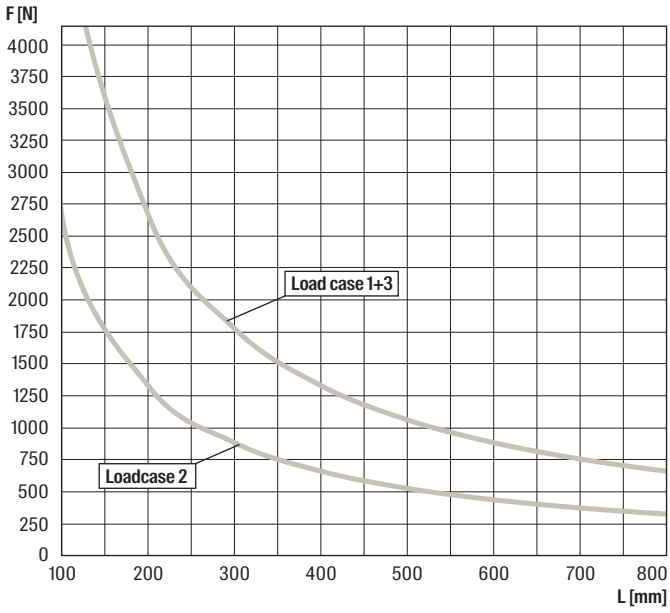

FCA 62

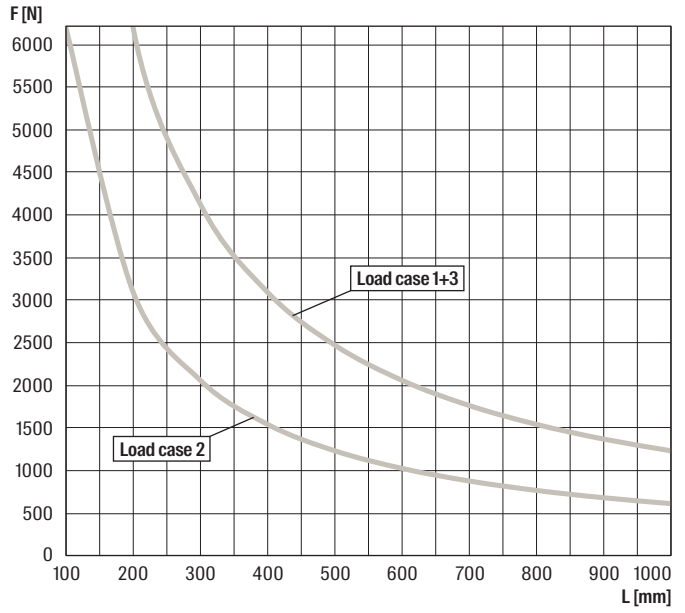

3a

For the load curves, the permissible steel strain $\delta_{adm.} = 160$ N/mm and the maximum deflection under load $L/150$ are not exceeded. Load values of the cantilever arms under consideration of the load capacity of the base plate. Fixings and screw fastenings must be calculated accordingly.

FCA 41D

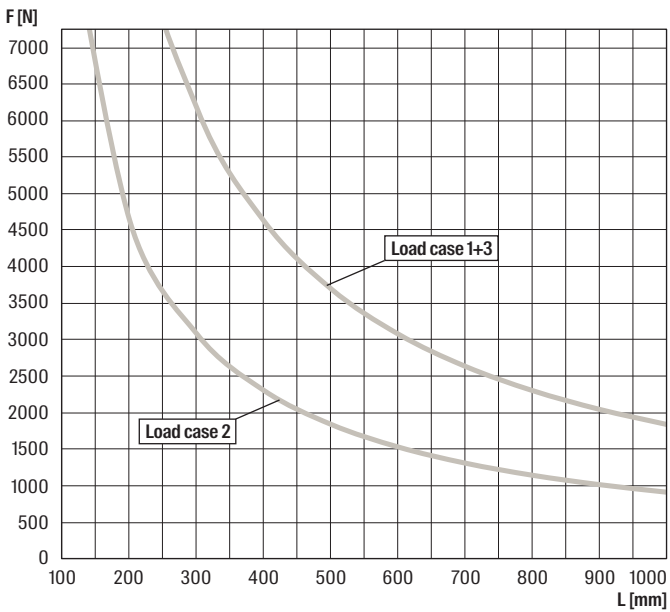

For the load curves, the permissible steel strain $\delta_{adm.} = 160$ N/mm and the maximum deflection under load $L/150$ are not exceeded. Load values of the cantilever arms under consideration of the load capacity of the base plate. Fixings and screw fastenings must be calculated accordingly.

Large cantilever arm FCAM hdg.

The large cantilever arm for heavy loads



Sliding element on cantilever



Applications

- Quick and easy installation of pipelines with heavy loads
- For indoor and outdoor applications and in environments with high stress to components due to corrosion

Advantages/benefits

- The robust construction, consisting of a basic and a support profile, allows the bearing of heavy loads.
- The graduated range of lengths allows an ideal adaptation to the application.
- The base plate's long slots, which are at 90° to one another, allow the arm to be easily aligned.
- The stamped teeth in the channel give the sliding nuts a secure hold for high shear loads, e.g. for vertical installation.
- The surface coating creates a high corrosion protection against environmental influences like humidity, water, saltwater or other corrosive substances.

Properties

- Material: steel S235 JR (material no.10037) acc. to DIN EN 10025
- Zinc plating: hot-dip galvanised, min. 45 µm, acc. to DIN EN ISO 1461

3a

Technical data

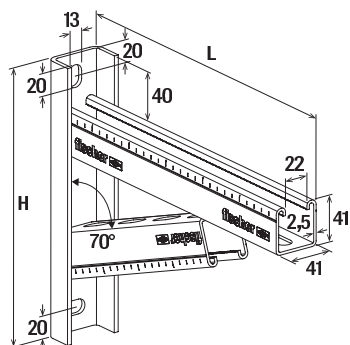

FCAM

Item	Item No.	Length L [mm]	Height H [mm]	Sales unit [pcs]
FCAM 300 hdg.	538018	300	246	1
FCAM 400 hdg.	538019	400	270	1
FCAM 500 hdg.	538020	500	284	1
FCAM 600 hdg.	538021	600	319	1
FCAM 700 hdg.	538022	700	343	1

Loads

Item	Item No.	Max. recommended static load load case 1 F_{rec} [kN]	Max. recommended static load load case 2 F_{rec} [kN]	Max. recommended static load load case 3 F_{rec} [kN]
FCAM 300 hdg.	538018	7.0	3.7	7.0
FCAM 400 hdg.	538019	7.5	2.8	7.5
FCAM 500 hdg.	538020	6.5	2.3	6.5
FCAM 600 hdg.	538021	6.0	1.9	6.0
FCAM 700 hdg.	538022	5.5	1.3	5.5

Load case 1

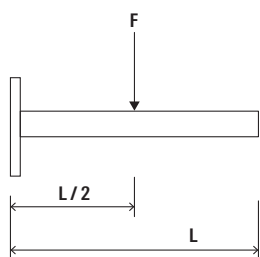

Load case 2

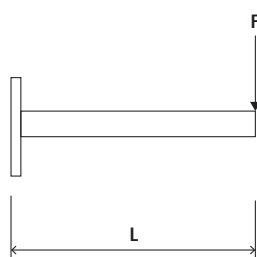

Load case 3

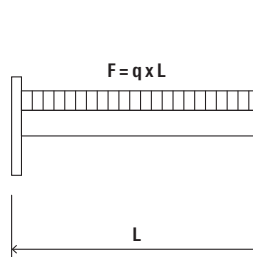

Cover cap FEC



FEC 21 B



FEC 41 B

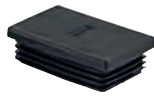

FEC 62 B

Item	Item No.	For profile	Material	Sales unit [pcs]
FEC 21 B	077357	41/21	Polyethylene, black	100
FEC 41 B	077355	41/41	Polyethylene, black	100
FEC 62 B	505551	41/62	Polyethylene, black	100

Push-through connector PFCN 41 zl

Push-through connector for the quickest and easiest connection of FUS profiles



Cross connection on channel



Cantilever with saddle flange

Applications

- Connection of FUS channels and construction elements by push-through principle
- Universal fitting for all push-through connection elements and FUS profiles
- For indoor and outdoor applications and in environments with high stress to components due to corrosion

Advantages/benefits

- The correct fit of the push-through connector and connection elements allows the quickest and easiest channel connection.
- The spring effect of the PFCN in set state guarantees a simple and precise positioning in the channel.
- The teeth on the push through connector provide a secure hold in the FUS channel.
- Installation by rotating 90° enables generally the post-installation in set channels.
- The surface coating creates a high corrosion protection against environmental influences like humidity, water, saltwater or other corrosive substances.

Properties

- Material Cap: steel DD11 (material no. 1.0332) acc. to DIN EN 10111
- Material Sliding nut: steel S420MC, EN 10149-2
- Material Hexagon screw: 8.8 M10-28, DIN 933
- Material Plastic parts: polypropylene
- Coating: zinclamella acc. to DIN EN ISO 12944, min. 8 µm

Installation PFCN 41

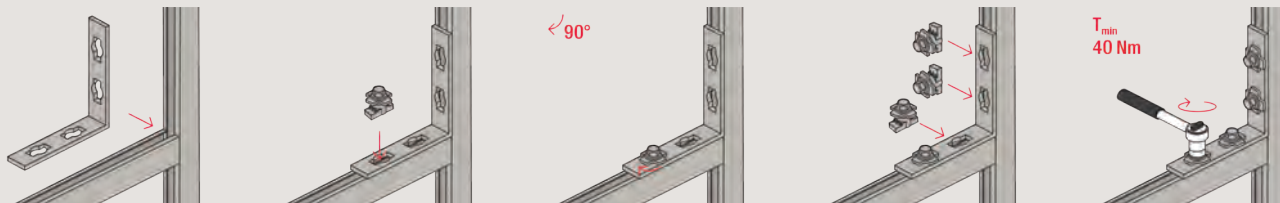

Technical data

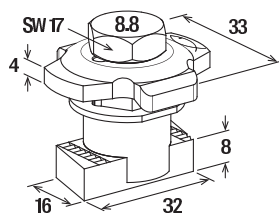

PFCN

Item	Item No.	Thread	Sales unit
PFCN 41 zl	542733	A M 10	[pcs] 50

Loads

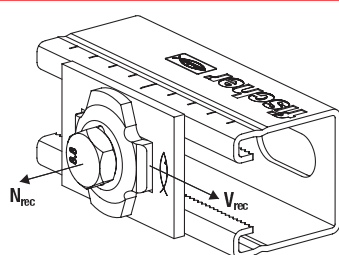

PFCN 41

Item	Item No.	Max. recommended tension load for FUS 2,0 mm	Max. recommended tension load for FUS 2,5 mm	Max. recommended shear load for FUS 2,0 mm	Max. recommended shear load for FUS 2,5 mm	Tightening torque for screw grade ≥ 8.8
		N_{rec} [kN]	N_{rec} [kN]	[kN]	[kN]	T_{inst} [Nm]
PFCN 41 zl	542733	5.0	7.0	4.0	4.0	40

3a

Saddle flange PSF zl

Construction element - Saddle flange PSF zl



Pipe installation in escape route



Cantilever with saddle flange

Applications

- Stable construction of connections between channels and building structures for the push-through system
- For indoor and outdoor applications and in environments with high stress to components due to corrosion

Advantages/benefits

- The perfect-fit saddle allows a simple installation by inserting the mounting channels
- The saddle flange's stable design offers a secure hold for a load-bearing construction
- The surface coating creates a high corrosion protection against environmental influences like humidity, water, saltwater or other corrosive substances.

Properties

- Material: steel DD11 (material no. 1.0332) acc. to DIN EN 10111
- Coating: zinclamella acc. to DIN EN ISO 12944, min. 8 µm

Technical data

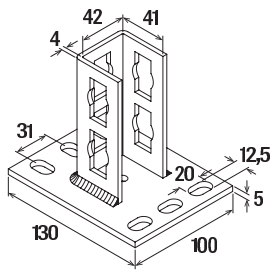

PSF 41

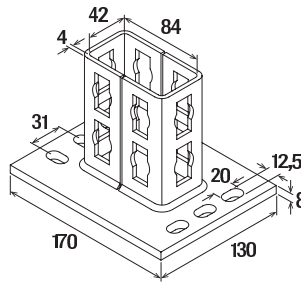

PSF 82

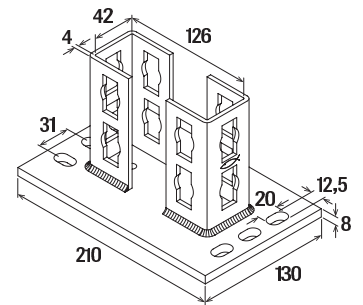

PSF 124

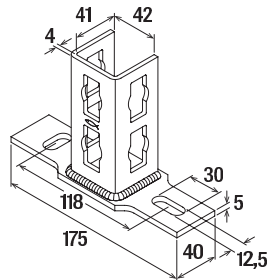

PSFQ 41

Item	Item No.	For profile	Sales unit
			[pcs]
PSF 41 zl	542715	21D, 41, 62	10
PSF 82 zl	542716	41 D	5
PSF 124 zl	542718	62 D	5
PSFQ 41 zl	542723	41	10

Loads

See Push-through connector PFCN 41 zl

Universal bracket PUWS zI

Construction element - Universal bracket PUWS zI

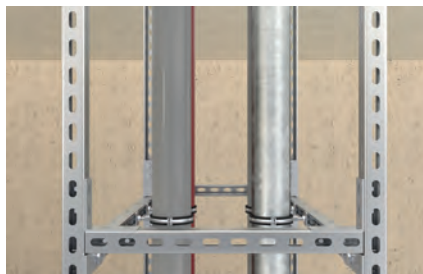

3D-frame constructions



Support systems for ventilation

Applications

- Reinforcement of supporting structures for the push-through system
- For indoor and outdoor applications and in environments with high stress to components due to corrosion

Advantages/benefits

- The universal brackets for the connection of FUS channels gives a supporting structure, great stability and safety (we recommend using in pairs).
- The surface coating creates a high corrosion protection against environmental influences like humidity, water, saltwater or other corrosive substances.

Properties

- Material: steel DD11 (material no. 1.0332) acc. to DIN EN 10111
- Coating: zinclamella acc. to DIN EN ISO 12944, min. 8 µm

Technical data

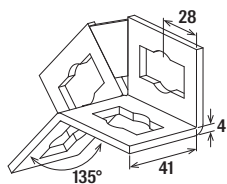

PUWS 2 x 2/135°

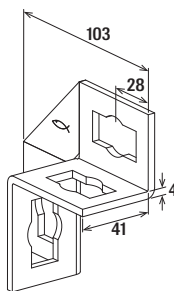

PUWS 2 x 2

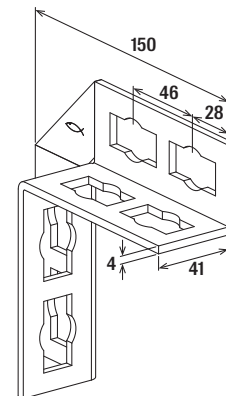

PUWS 4 x 4

Item	Item No.	Sales unit
		[pcs]
PUWS 2 x 2/135° zI	542708	10
PUWS 2 x 2 zI	542709	10
PUWS 4 x 4 zI	542710	8

Loads

See Push-through connector PFCN 41 zI

Angle bracket PWK zl

Construction element - Angle bracket PWK zl



Solid frame construction

Applications

- Reinforcement in the push-through system and for lateral fixing to the substrate
- For indoor and outdoor applications and in environments with high stress to components due to corrosion

Advantages/benefits

- The stable angle bracket ensures a supporting structure with a very high level of stability and safety.
- The surface coating creates a high corrosion protection against environmental influences like humidity, water, saltwater or other corrosive substances.

Properties

- Material: steel DD11 (material no. 1.0332) acc. to DIN EN 10111
- Coating: zinclamella acc. to DIN EN ISO 12944, min. 8 µm

3a

Technical data

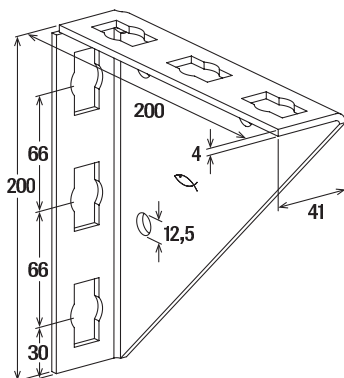

PWK 200

Item	Item No.	Sales unit
		[pcs]
PWK 200/200 zl	542720	15

Loads

See Push-through connector PFCN 41 zl

Variable bracket PVB zl

Construction element – Variable bracket PVB zl



Massive bracing of cantilever arm

Applications

- Variable angular positioning of profile support in the push-through system
- Bracket for installation with FUS channels from 0° to 180°
- For indoor and outdoor applications and in environments with high stress to components due to corrosion

Advantages/Benefits

- The design of the variable bracket PVB zl enables the fixation of mounting channels at an angle of 0° to 180°.
- The holes in the connecting element make it compatible with the push-through connector PFCN zl.
- The punched holes in the base plate allow the direct fixing onto a wall, ceiling or onto a mounting channel by screw or anchor.
- The surface coating creates a high corrosion protection against environmental influences like humidity, water, saltwater or other corrosive substances.

Properties

- Material: steel DD11 (material no. 1.0332) acc. to DIN EN 10111
- Coating: zinclamella acc. to DIN EN ISO 12944, min. 8 µm

Technical data

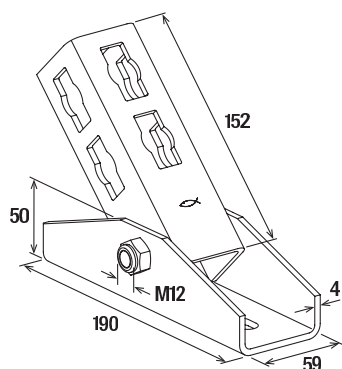

PVB

Item	Item No.	Sales unit
		[pcs]
PVB zl	542722	5

Loads

See Push-through connector PFCN 41 zl

Bracing elements PSAE zl

Construction elements – Bracing elements PSAE zl 300 and 500



Supported channel

Applications

- Elements for stable cantilever constructions made of FUS channels or FCA cantilever arms with push-through connector PFCN zl
- For indoor and outdoor applications and in environments with high stress to components due to corrosion

Advantages/benefits

- The stable bracing element PSAE zl gives the supporting structure very high stability and safety.
- The holes in the base plate of the element make it compatible with the push-through connector PFCN zl.
- An additional PU-washer allows for fixing of elements with formholes directly onto a wall or ceiling by anchor or screw.
- The surface coating creates a high corrosion protection against environmental influences like humidity, water, saltwater or other corrosive substances.

Properties

- Material: steel DD11 (material no. 1.0332) acc. to DIN EN 10111
- Coating: zinclamella acc. to DIN EN ISO 12944, min. 8 µm

3a

Installation PSAE

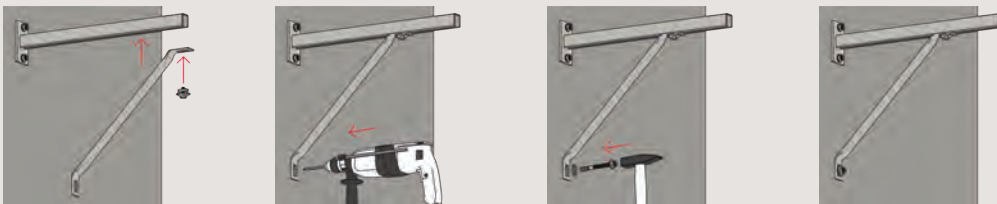

Technical data

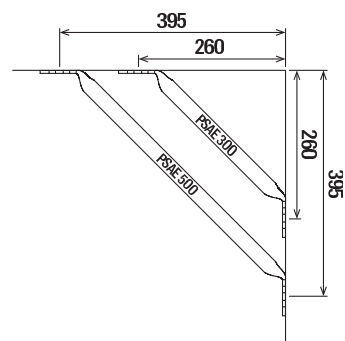
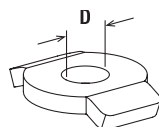
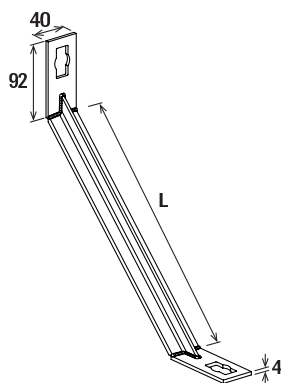

PSAE

PU

PSAE 300 and PSAE 500

Item	Item No.	Length L [mm]	Sales unit [pcs]
PSAE zl 300 Brace element	542726	300	10
PSAE zl 500 Brace element	542727	500	10
PU zl 10,5 Washer	542728	—	50
PU zl 12,5 Washer	542729	—	50

Loads

See Push-through connector PFCN 41 zl

Bracket PFFF zl

Construction elements - Brackets PFFF zl

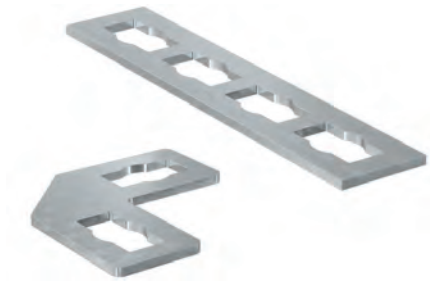

Waste water pipe

Applications

- Arrangement of simple channel constructions in the push-through system
- For indoor and outdoor applications and in environments with high stress to components due to corrosion

Advantages/benefits

- The holes in the connecting elements make them compatible with the push-through connector PFCN zl.
- The surface coating creates a high corrosion protection against environmental influences like humidity, water, saltwater or other corrosive substances.

Properties

- Material: steel DD11 (material no. 1.0332) acc. to DIN EN 10111
- Coating: zinclamella acc. to DIN EN ISO 12944, min. 8 µm

3a

Technical data

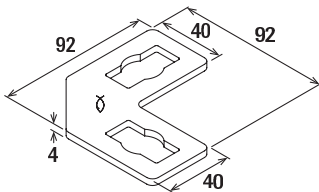

PFFF 2L

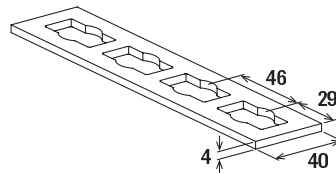

PFFF 4I

Item	Item No.	Sales unit
		[pcs]
PFFF 2L zl	542721	20
PFFF 4I zl	542725	25

Loads

See Push-through connector PFCN 41 zl

Bracket PFAF zl

Construction elements - Brackets PFAF zl

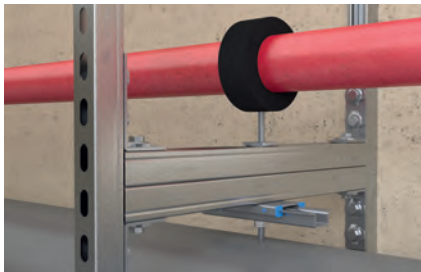

Frame constructions

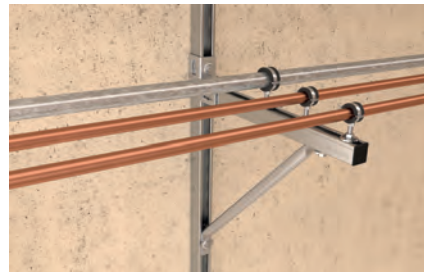

Leightweight installation on cantilever

Applications

- Arrangement of simple channel constructions in the push-through system
- For indoor and outdoor applications and in environments with high stress to components due to corrosion

Advantages/benefits

- The holes in the connecting elements make them compatible with the push-through connector PFCN zl.
- The surface coating creates a high corrosion protection against environmental influences like humidity, water, saltwater or other corrosive substances.

Properties

- Material: steel DD11 (material no. 1.0332) acc. to DIN EN 10111
- Coating: zinclamella acc. to DIN EN ISO 12944, min. 8 µm

Technical data

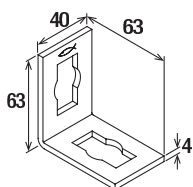

PFAF 2

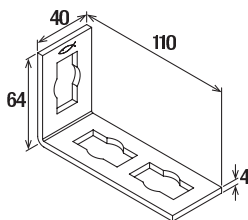

PFAF 3

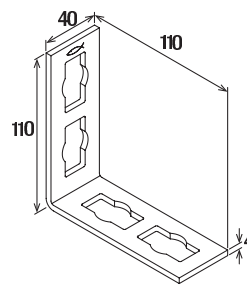

PFAF 4

Item	Item No.	Sales unit
		[pcs]
PFAF 2 zl	542711	25
PFAF 3 zl	542712	25
PFAF 4 zl	542724	25

Technical data

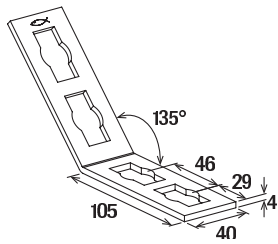

PFAF 4/135°

Item	Item No.	Sales unit
		[pcs]
PFAF 4/135° zI	542713	20

Loads

See Push-through connector PFCN 41 zI

Bracket PFUF zl

Construction elements - Brackets PFUF zl

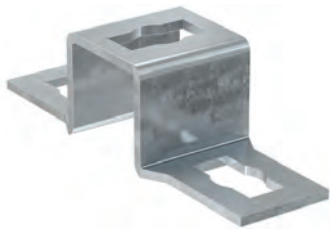

Cross connection on channel

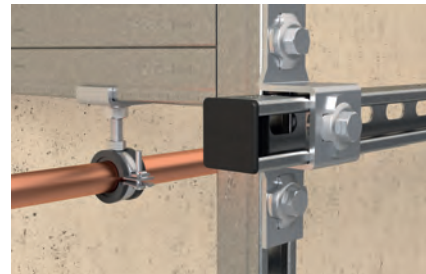

Cross connection on channel

Applications

- Connecting elements for multi-dimensional channel constructions
- For indoor and outdoor applications and in environments with high stress to components due to corrosion

Advantages/benefits

- The various shapes of the connecting elements offer flexibility during the installation of channel constructions.
- The holes in the connecting elements make them compatible with the push-through channel nut PFCN zl.
- The surface coating creates a high corrosion protection against environmental influences like humidity, water, saltwater or other corrosive substances.

Properties

- Material: steel DD11 (material no. 1.0332) acc. to DIN EN 10111
- Coating: zinclamella acc. to DIN EN ISO 12944, min. 8 µm

Technical data

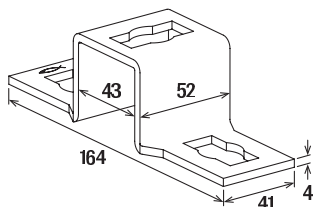

PFUF 41

Item	Item No.	Sales unit
		[pcs]
PFUF 41 zl	542714	25

Loads

See Push-through connector PFCN 41 zl

Brackets PFUF D zl

Construction elements - Bracket PFUF 3D zl and 4D zl

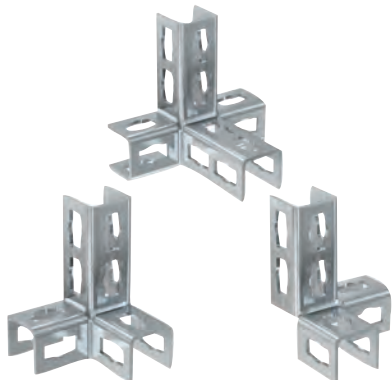

Frame constructions

Applications

- Element for multidimensional constructions with FUS channels connected by the push-through connector PFCN
- For indoor and outdoor applications and in environments with high stress to components due to corrosion

Advantages/Benefits

- The 3D PFUF zl construction elements enable multidimensional constructions in a very short time.
- The holes in the construction elements make them compatible with the push-through connector PFCN zl.
- The different shapes of the construction elements generate a high flexibility for channel constructions.
- The surface coating creates a high corrosion protection against environmental influences like humidity, water, saltwater or other corrosive substances.

Properties

- Material: steel DD11 (material no. 1.0332) acc. to DIN EN 10111
- Coating: zinclamella acc. to DIN EN ISO 12944, min. 8 µm

3a

Technical data

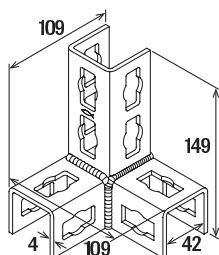

PFUF 3DL

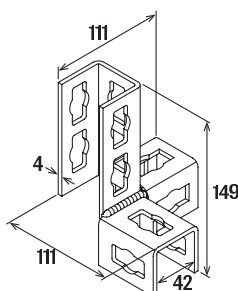

PFUF 3DR

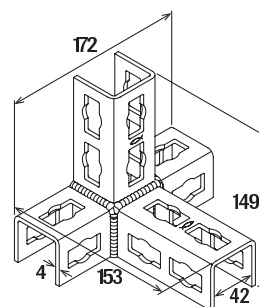

PFUF 4D

Item	Item No.	Sales unit
		[pcs]
PFUF 3DL zl	542730	10
PFUF 3DR zl	542731	10
PFUF 4D zl	542732	10

Loads

See Push-through connector PFCN 41 zl

Connector FCN Clix P hdg. / FCN Clix M hdg.

Channel nut for quick and easy fixing in FUS profiles



Connection on channel

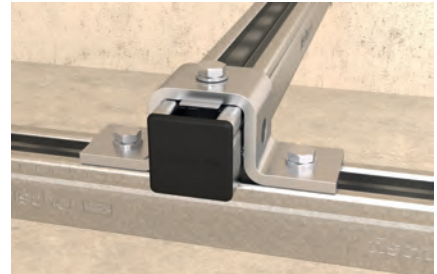

Cross connection

Applications

- Connection of FUS rails and fixtures
- Connection of pipe clamps with a threaded rod
- For indoor and outdoor applications and in environments with high stress to components due to corrosion

Advantages/benefits

- The sliding nut design allows for quick and easy setting in the channel.
- The spring effect of the plastic clasp guarantees simple and precise positioning in the channel.
- The FCN Clix P's flat plastic mounting with wings offers a good hold and allows the fixtures to be conveniently mounted.
- The teeth on the sliding nut provide a secure hold in the FUS channel.
- Installation by rotating 90° enables post-installation in installed channel.
- The surface coating creates a high corrosion protection against environmental influences like humidity, water, saltwater or other corrosive substances.

Properties

- Material: steel S235 JR (material no. 1.0037) acc. to DIN EN 10025, plastic Nylon PA6
- Zinc plating: hot-dip galvanised, min. 40 µm, acc. to DIN EN ISO 1461

Certificates



Fire resistance classification
R120



MLAR R30

Installation FCN Clix P

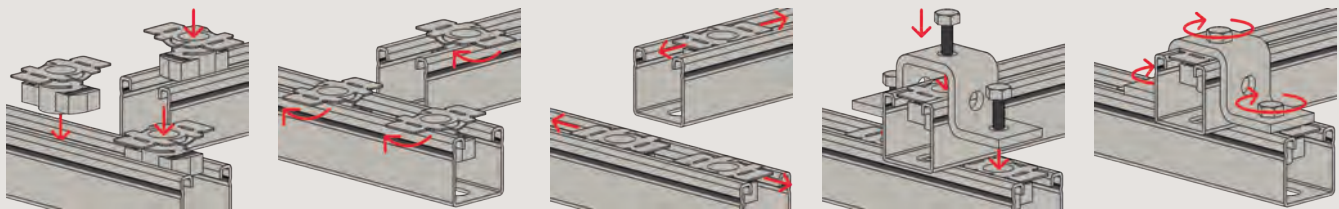

Installation FCN Clix M

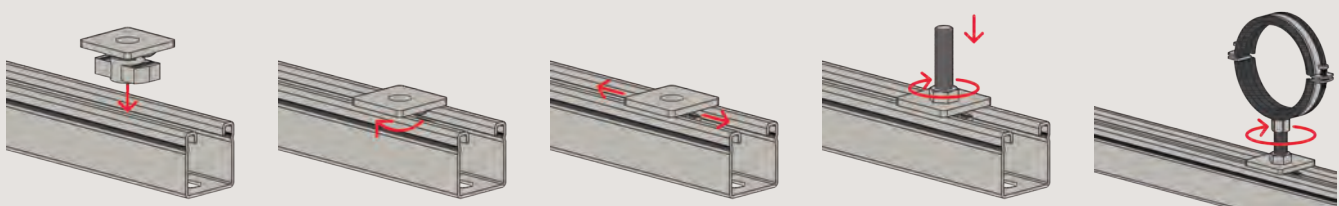

Technical data

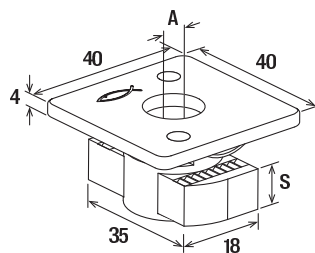
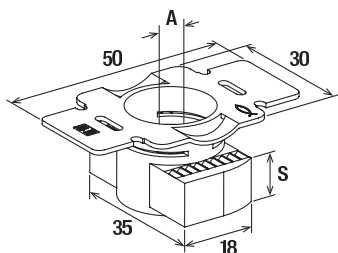

FCN Clix P

FCN Clix M

Item	Item No.	Fire test report	Thread A	Thickness S [mm]	Sales unit [pcs]
FCN Clix P 8 hdg.	538106	—	M 8	6	100
FCN Clix P 10 hdg.	538107	X	M 10	8	100
FCN Clix P 12 hdg.	517420	X	M 12	9.5	100
FCN Clix M 8 hdg.	538108	—	M 8	6	100
FCN Clix M 10 hdg.	538109	X	M 10	8	100
FCN Clix M 12 hdg.	538110	X	M 12	9.5	100

3a

Loads

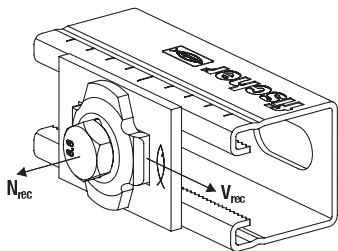

FCN Clix P and FCN Clix M

Item	Item No.	Max. recommended tension load for FUS 2,0 mm	Max. recommended tension load for FUS 2,5 mm	Max. recommended shear load for FUS 2,0/2,5 mm	Tightening torque for screw grade \geq 8.8	Tightening torque for screw grade \geq 4.6
		N_{rec} [kN]	N_{rec} [kN]	V_{rec} [kN]	T_{inst} [Nm]	T_{inst} [Nm]
FCN Clix P 8 hdg.	538106	4.0	4.0	1.0	20	—
FCN Clix P 10 hdg.	538107	5.0	8.0	1.5	40	—
FCN Clix P 12 hdg.	517420	5.0	8.0	2.0	50	—
FCN Clix M 8 hdg.	538108	4.0	4.0	—	—	10
FCN Clix M 10 hdg.	538109	5.0	8.0	—	—	15
FCN Clix M 12 hdg.	538110	5.0	8.0	—	—	20

Channel washer HK 41 hdg.

Connector - Channel washer HK hdg.

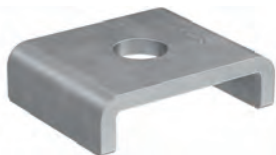

Lateral pipe mounting at channel



Channel installation at wall

Applications

- Channel washer to strengthen the profile
- For indoor and outdoor applications and in environments with high stress to components due to corrosion

Advantages/benefits

- The U-shape of the channel washer prevents the profile from bending effectively.
- The shape of the channel washer makes push-through installation of channel profiles quick and easy.
- The surface coating creates a high corrosion protection against environmental influences like humidity, water, saltwater or other corrosive substances.

Properties

- Material: steel S235 JR (material no.: 1.0037) acc. to DIN EN 10025
- Zinc plating: hot-dip galvanised, min. 45 µm, acc. to DIN EN ISO 1461

3a

Certificates



Fire resistance classification
R120



MLAR R30

Technical data

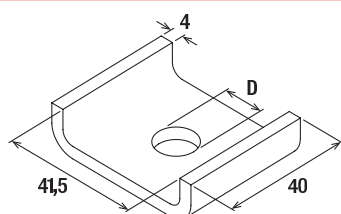

HK 41

Item	Item No.	Fire test report	Hole-Ø D [mm]	Sales unit [pcs]
HK 41 10,5 hdg.	547495	X	10.5	50
HK 41 12,5 hdg.	547496	X	12.5	50

Saddle flange SF hdg.

Construction element - Saddle flange SF hdg.



Pipe installation in escape route



Cantilever with saddle flange

Applications

- For solid connections between the channel and building structures
- For indoor and outdoor applications and in environments with high stress to components due to corrosion

Certificates



Fire resistance classification
R120



MLAR R30

Advantages/benefits

- The perfect-fit saddle of the SF allows simple installation by inserting the mounting channel.
- The saddle flange's stable design offers a secure hold for load-bearing construction.
- The surface coating creates a high corrosion protection against environmental influences like humidity, water, saltwater or other corrosive substances.

Properties

- Material base plate: steel DC01 (material no.1.0330) acc. to DIN EN 10139
- Zinc plating base plate: hot-dip galvanized, min. 45 µm, acc. to DIN EN ISO 1461
- Material U-Profile: steel S235 JR (material no. 1.0037) nach DIN EN 10025
- Zinc-plating U-Profile: hot-dip galvanized, min. 45 µm, acc. to DIN EN ISO 1461

3a

Technical data

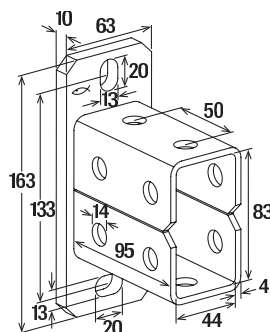
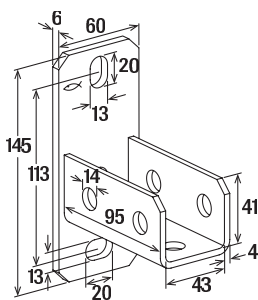

SF L 82

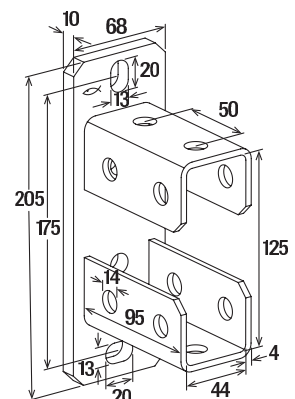

SF L 124

Item	Item No.	Fire test report	For profile	Sales unit [pcs]
SF L 41 hdg.	517421	X	21, 41, 21D, 62	10
SF L 82 hdg.	538125	—	41 D	5
SF L 124 hdg.	538126	—	62 D	5

Loads

See Connector FCN Clix P hdg.

Mounting bracket UWS hdg.

Construction element - Universal bracket UWS hdg.

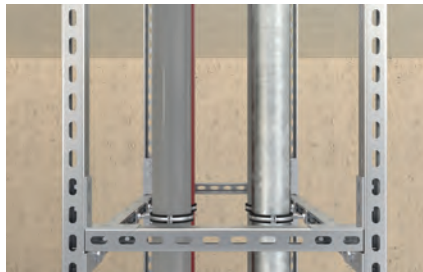

3D-frame constructions



Support systems for ventilation

Applications

- Universal angle bracket for the reinforcement of supporting structures
- For indoor and outdoor applications and in environments with high stress to components due to corrosion

Advantages/benefits

- The universal bracket for connecting fischer mounting channels gives a supporting structure great stability and safety (we recommend using in pairs).
- The surface coating creates a high corrosion protection against environmental influences like humidity, water, saltwater or other corrosive substances.

Properties

- Material: steel S235 JR (material no.: 1.0037) acc. to DIN EN 10025
- Zinc plating: hot-dip galvanised, min. 45 µm, acc. to DIN EN ISO 1461

Certificates



Fire resistance classification
R120



MLAR R30

Technical data

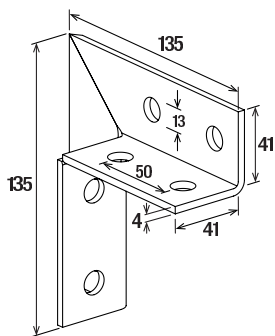

UWS

Item	Item No.	Fire test report	Sales unit
UWS hdg.	538115	X	[pcs] 10

Loads

See Connector FCN Clix P hdg.

Angle bracket WK hdg.

Construction element - Angle bracket WK hdg.

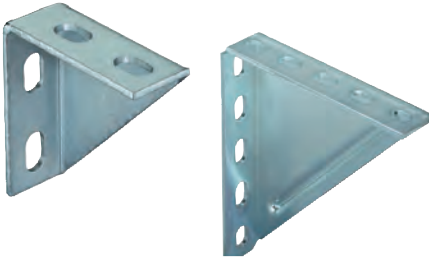

Heavy drainage pipe under angle bracket



Solid frame construction

Applications

- Reinforcement and fixing of pipelines and pipe components
- For indoor and outdoor applications and in environments with high stress to components due to corrosion

Advantages/benefits

- The design of the angle bracket allows the fixing of pipe clamps or mounting channels.
- The stable angle ensures a very high level of stability and safety to the structure.
- The surface coating creates a high corrosion protection against environmental influences like humidity, water, saltwater or other corrosive substances.

Properties

- Material: steel S235 JR (material no. 1.0037) acc. to DIN EN 10025
- Zinc plating: hot-dip galvanised, min. 45 µm, acc. to DIN EN ISO 1461

3a

Technical data

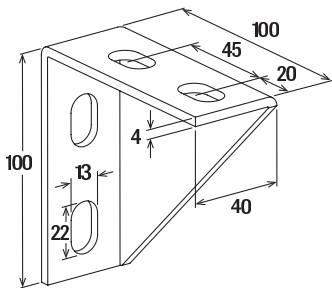

WK 100/100

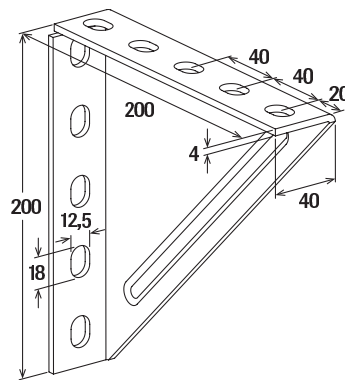

WK 200/200

Item	Item No.	Sales unit
		[pcs]
WK 100/100 hdg.	538117	5
WK 200/200 hdg.	538118	5

Load case 1

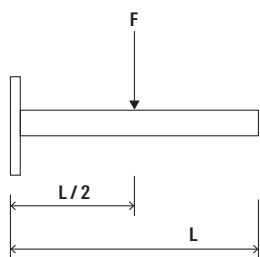

Load case 2

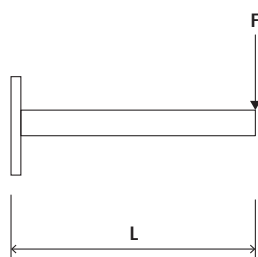

Loads

Item	Item No.	Max. recommended static load load case 1	Max. recommended static load load case 2
		F_{rec} [kN]	F_{rec} [kN]
WK 100/100 hdg.	538117	–	4.0
WK 200/200 hdg.	538118	4.0	1.8

3a

Variable bracket VB hdg.

Construction element – Variable bracket VB hdg.



Massive bracing of cantilever arm

Applications

- Variable bracket for FUS channel profiles to built up supporting structures
- Bracket for installation with FUS channels from 0° to 180°
- For indoor and outdoor applications and in environments with high stress to components due to corrosion

Advantages/Benefits

- The design of the variable bracket VB enables the fixation of mounting channels at an angle of 0° to 180°.
- Due to the perforations on all sides of the VB, rails can be mounted with the rail opening facing downwards or laterally.
- The punched holes in the base plate allow the direct fixing onto a wall, ceiling or onto a mounting channel.
- The surface coating creates a high corrosion protection against environmental influences like humidity, water, saltwater or other corrosive substances.

Properties

- Material: steel S235 JR (material no.10037) acc. to DIN EN 10025
- Zinc plating: hot-dip galvanised, min. 45 µm, acc. to DIN EN ISO 1461

3a

Technical data

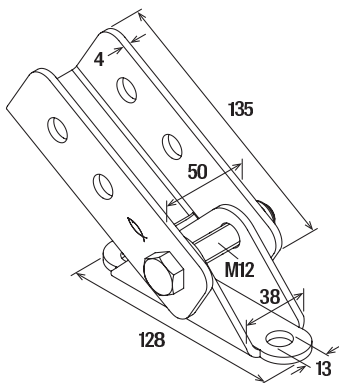

VB

Item	Item No.	Sales unit
		[pcs]
VB hdg.	545771	5

Loads

See Connector FCN Clix P hdg.

Threaded rod bracket FSB 45° hdg.

Construction element - Threaded rod bracket FSB 45° hdg.



Bracing for fixpoint



Heavy pipe on cantilever

Applications

- 45°-element for anchoring with M10 threaded rods
- For indoor and outdoor applications and in environments with high stress to components due to corrosion

Advantages/benefits

- The anchoring element's socket allows the fast insertion of a pre-mounted M10 threaded rod with nut.
- The hole in the base plate allows the direct fixing onto a wall or ceiling, or onto a mounting channel.
- The surface coating creates a high corrosion protection against environmental influences like humidity, water, saltwater or other corrosive substances.

Properties

- Material: steel S235 JR (material no.: 1.0037) acc. to DIN EN 10025
- Zinc plating: hot-dip galvanised, min. 45 µm, acc. to DIN EN ISO 1461

Technical data

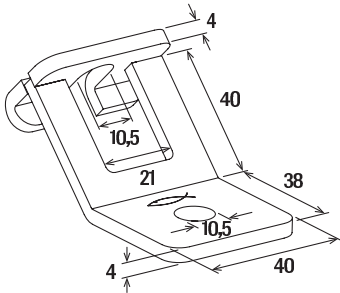

FSB 45°

Item	Item No.	Sales unit
		[pcs]
FSB 45° hdg.	538120	20

Loads

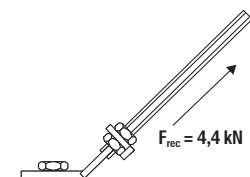

Beam clamp TKR hdg.

Clamp for fixing of profiles to steel girders



Channel to steelbeam

Applications

- Fixing to steel girders
- For indoor and outdoor applications and in environments with high stress to components due to corrosion

Advantages/benefits

- The design of the beam clamp allows fixing without drilling or welding.
- The various lengths of the beam clamp allow the fixing on most standard beams.
- The shape of the beam clamp allows a simple adjustment of the channel connection.
- The surface coating creates a high corrosion protection against environmental influences like humidity, water, saltwater or other corrosive substances.

Properties

- Material plate/U-bolt pipe hanger: steel S235 JR (material no.10037) acc. to DIN EN 10025
- Material hexagon nut: steel resistance class 8
- Zinc plating: hot-dip galvanised, min. 40 - 45 µm, acc. to DIN EN ISO 1461

3a

Technical data

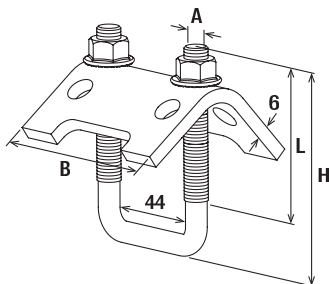

TKR

Item	Item No.	For profile	Thread A	Width B [mm]	Height H [mm]	Length L [mm]	Sales unit [pcs]
TKR 21- 42 hdg.	538122	21, 41	M 10	79	97	48	20
TKR 82 hdg.	538123	62, 41D	M 10	79	137	80	20
TKR 124 hdg.	538124	62 D	M 10	79	179	80	10

Loads

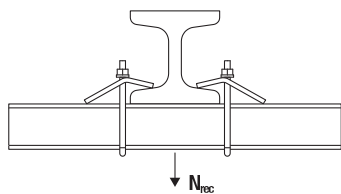

TKR

Item	Item No.	Max. recom. static load (centr. tension) $N_{\text{recom.}}$ [kN]	Tightening torque T_{inst} [Nm]
TKR 21- 42 hdg.	538122	10.0	20
TKR 82 hdg.	538123	10.0	20
TKR 124 hdg.	538124	10.0	20

3a

Bracket FFF hdg.

Construction elements - Brackets FFF hdg.

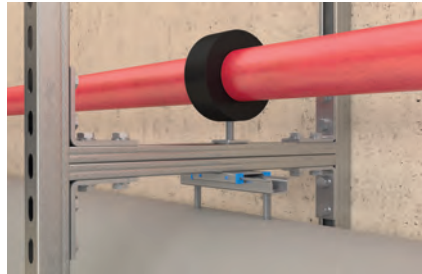
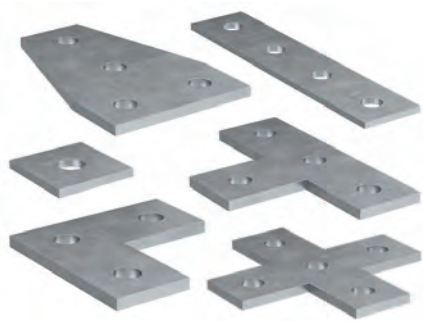

Frame constructions



Connection on channel

Applications

- Connecting elements for the joining or strengthening of simple channel constructions
- For indoor and outdoor applications and in environments with high stress to components due to corrosion

Properties

- Material: steel S235 JR (material no.: 1.0037) acc. to DIN EN 10025, FFF 5C uses Q235B (equivalent to S235JR)
- Zinc plating: hot-dip galvanised, min. 45 µm, acc. to DIN EN ISO 1461

3a

Technical data

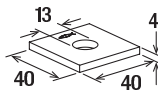

FFF 1

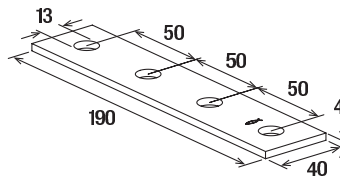

FFF 4

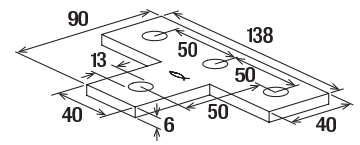

FFF 4T

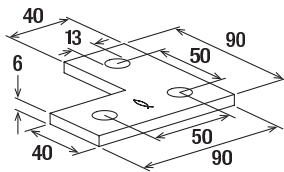

FFF 3L

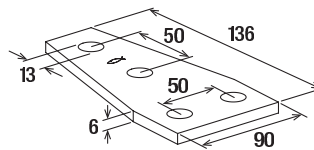

FFF 4D

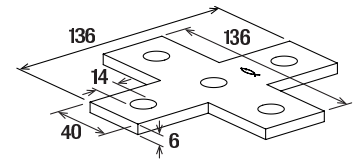

FFF 5C

Item	Item No.	Sales unit
		[pcs]
FFF 1 hdg.	537580	25
FFF 3L hdg.	537581	25
FFF 4 hdg.	537582	25
FFF 4T hdg.	537583	25
FFF 4D hdg.	537584	25
FFF 5C hdg.	553075	20

Loads

See Connector FCN Clix P hdg.

Bracket FAF hdg.

Construction elements - Mounting bracket FAF hdg.

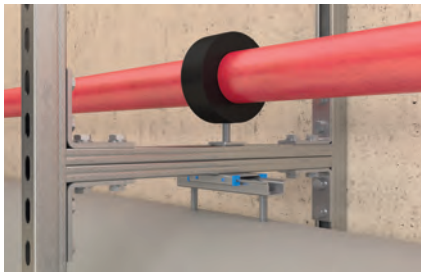

Frame constructions

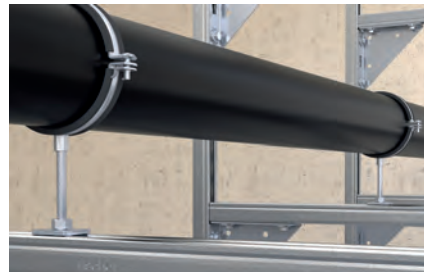

Connection on channel

Applications

- Connecting elements for the joining or strengthening of simple channel constructions
- For indoor and outdoor applications and in environments with high stress to components due to corrosion

Properties

- Material: steel S235 JR (material no.: 1.0037) acc. to DIN EN 10025
- Zinc plating: hot-dip galvanised, min. 45 µm, acc. to DIN EN ISO 1461

Technical data

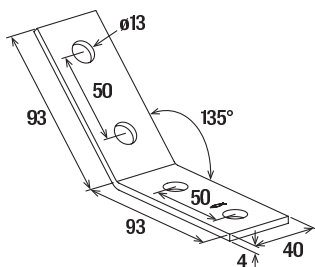

FAF 4/135°

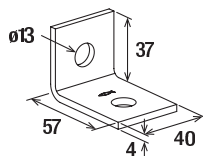

FAF 2

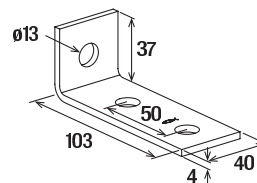

FAF 3

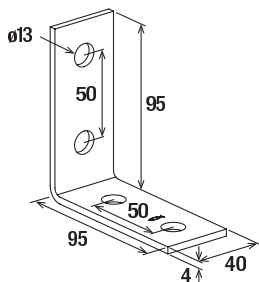

FAF 4

Item	Item No.	Sales unit
		[pcs]
FAF 4/135° hdg.	547511	25
FAF 2 hdg.	547508	25
FAF 3 hdg.	547509	25
FAF 4 hdg.	547510	25

Loads

See Connector FCN Clix P hdg.

Flanges FUF hdg.

Construction elements - Mounting brackets FUF hdg.

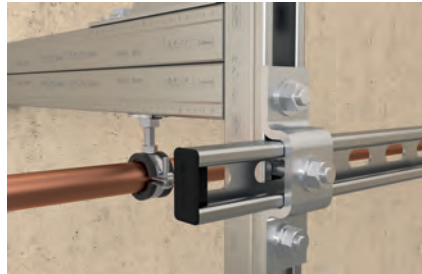

Cross connection on channel

Applications

- Connecting elements for multi-dimensional channel constructions
- For indoor and outdoor applications and in environments with high stress to components due to corrosion

Advantages/Benefits

- The various shapes of the connecting elements offer flexibility when it comes to the installation of rail constructions.
- The holes in the connecting elements make them compatible with the FCN Clix P.
- The surface coating creates a high corrosion protection against environmental influences like humidity, water, saltwater or other corrosive substances.

Properties

- Material: steel S235 JR (material no.: 1.0037) acc. to DIN EN 10025, FUF 62 uses Q235B (equivalent to S235JR)
- Zinc plating: hot-dip galvanised, min. 45 µm, acc. to DIN EN ISO 1461

3a

Technical data

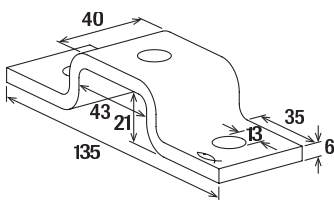

FUF 21

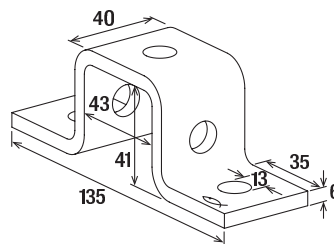

FUF 41

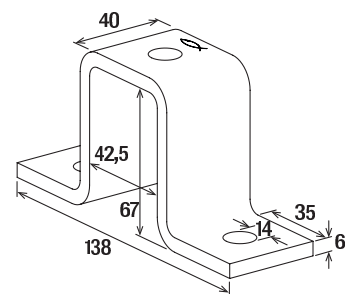

FUF 62

Item	Item No.	Sales unit
		[pcs]
FUF 21 hdg.	537588	25
FUF 41 hdg.	537589	25
FUF 62 hdg.	553083	15

Loads

See Connector FCN Clix P hdg.

Flanges FUF hdg.

Construction elements - Mounting brackets FUF hdg.

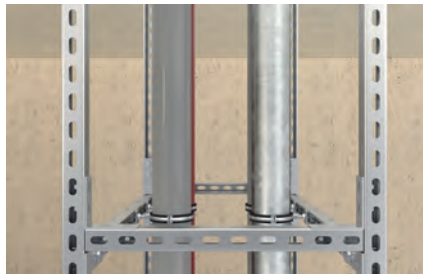
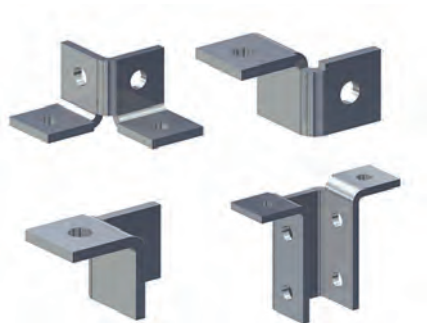

3D-frame constructions

Applications

3a

- Connecting elements for multi-dimensional channel constructions
- For indoor and outdoor applications and in environments with high stress to components due to corrosion

Advantages/Benetits

- The various shapes of the connecting elements offer flexibility when it comes to the installation of rail constructions.
- The holes in the connecting elements make them compatible with the FCN Clix P.
- The surface coating creates a high corrosion protection against environmental influences like humidity, water, saltwater or other corrosive substances.

Properties

- Material: steel S235 JR (material no.: 1.0037) acc. to DIN EN 10025, FUF 62 uses Q235B (equivalent to S235JR)
- Zinc plating: hot-dip galvanised, min. 45 µm, acc. to DIN EN ISO 1461

Technical data

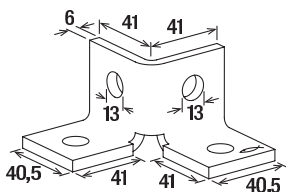

FUF 4Y

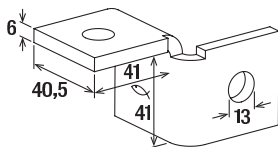

FUF 180°L

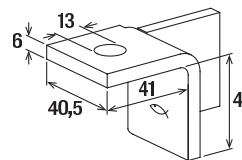

FUF 180°R

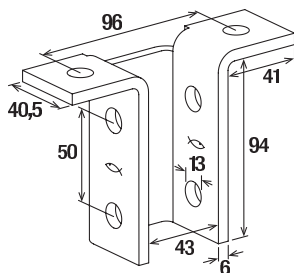

FUF 8T

Item	Item No.	Sales unit
		[pcs]
FUF 4Y hdg.	537585	20
FUF 180°L hdg.	537586	20
FUF 180°R hdg.	537587	20
FUF 8T hdg.	537590	10

Loads

See Connector FCN Clix P hdg.

Threaded rod G hdg.

Technical data

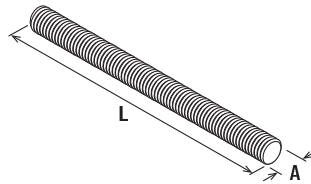

Properties

- Material: steel acc. to DIN 10139
- Zinc plating: min. 50 µm acc. to DIN EN ISO 12683

G

G

Item	Item No.	Thread A	Length L [mm]	Sales unit [pcs]
G 8 zl	537691	M 8	1000	25
G 10 hdg.	537694	M 10	1000	25
G 12 hdg.	537695	M 12	1000	20
G 16 hdg.	537696	M 16	1000	10

3a

Washer U mz

Technical data



Properties

- Material: steel acc. to DIN 10139
- Zinc plating: min. 50 µm acc. to DIN EN ISO 12683

U

Item	Item No.	Thickness S [mm]	External-Ø d [mm]	Hole-Ø D [mm]	Sales unit [pcs]
U 8 x 28 mz	537682	2	28	8.4	100
U 10 x 21 mz	537683	2	21	10.5	100
U 10 x 40 mz	537684	3	40	10.5	100
U 12 x 24 mz	537685	2.5	24	13	100
U 12 x 40 mz	537686	3	40	13	100

Hexagonal nut MU hdg.

Technical data

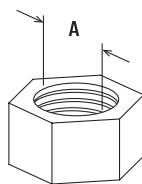

MU

MU

Item	Item No.	Thread A	Width across nut SW [mm]	Sales unit [pcs]
MU M8 hdg.	537687	M 8	13	100
MU M12 hdg.	537689	M 12	19	100
MU M10 hdg.	537688	M 10	17	100
MU M16 hdg.	537690	M 16	24	50

Properties

- Material: steel acc. to DIN 267-4, strength category 8
- Zinc plating: hot-dip galvanised, approx. 40 µm, acc. to DIN EN ISO 10684

3a

Hexagonal screw SKS hdg.

Technical data

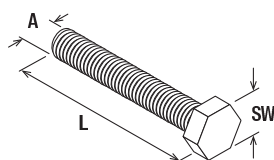

SKS

SKS

Item	Item No.	Thread A	Width across nut SW [mm]	Sales unit [pcs]
SKS 10 x 25 hdg.	537681	M 10	17	100
SKS 12 x 25 hdg.	537680	M 12	19	100

Properties

- Material: steel acc. to DIN-EN-ISO 898-1, steel 8.8
- Zinc plating: hot-dip galvanised, min. 40 µm, acc. to DIN EN ISO 10684

Channel connector FDCC zI

FDCC zI channel connector - For easy preparation of FUS double channels

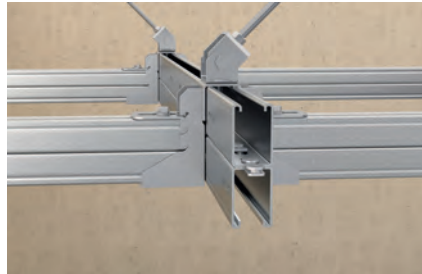

FUS double channel with channel connector

Applications

- Easy construction of double channels made from the FUS channel assortment.
- Suitable for FUS channels FUS 41 and FUS 62 with thickness 2,0 and 2,5 mm.
- The connection of two single channels is made with the channel connector inside the channel slots.
- Each double channel has to be equipped with an FDCC at both ends and additional FDCCs in the given installation distance as per load chart.
- For indoor and outdoor applications and in environments with high stress to components due to corrosion

Advantages/benefits

- Easy connection of single channels backside to backside to build double channels
- Simple solution to create individual double channels on job site
- The steel surface coating offers good corrosion protection against environmental influences like moisture, water, salt water and other corrosive agents

Properties

- Material base plate: JIS G3131-SPHE (similar to DD13 according to DIN EN 10111, material no.: 1.0335)
- Material screw: steel grade 8.8
- Surface coating: Specialised, zinc flake-based coating approx. 8-10 µm

3a

Technical data

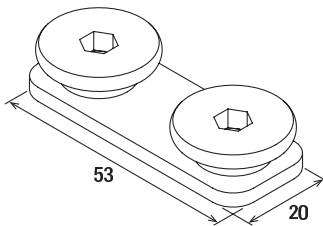

FDCC

Item	Item No.	Thread A	Drive	Tightening torque T_{inst} [Nm]	Sales unit [pcs]
FDCC zI	557278	M 10	Hexagon socket 5 mm	25	100

FUS 41D/2,0 - 2,5

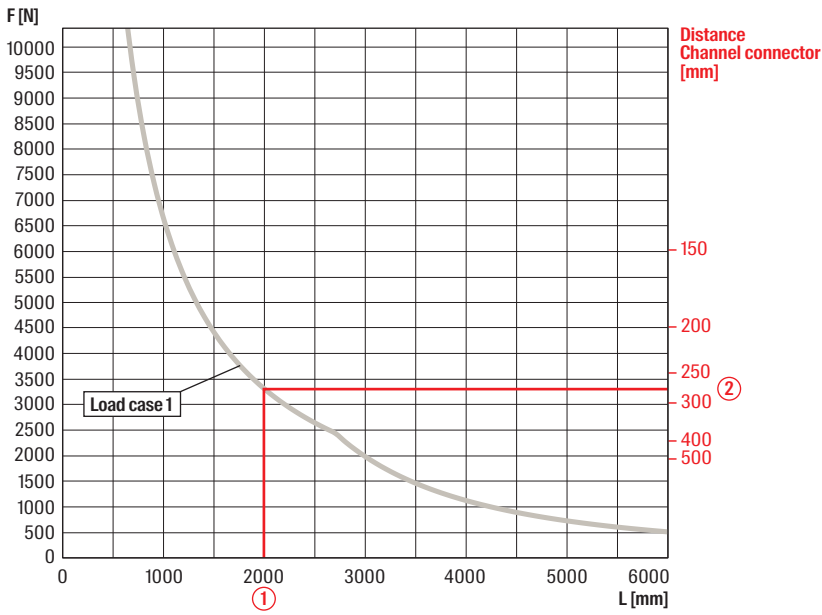

3a

- ① Length of channel, i.e. 2000 mm for loadcase 1 (single load centric)
- ② Distance of channel connector (for intermediate values use the lower value, i.e. 250 mm)

FUS 62D/2,5

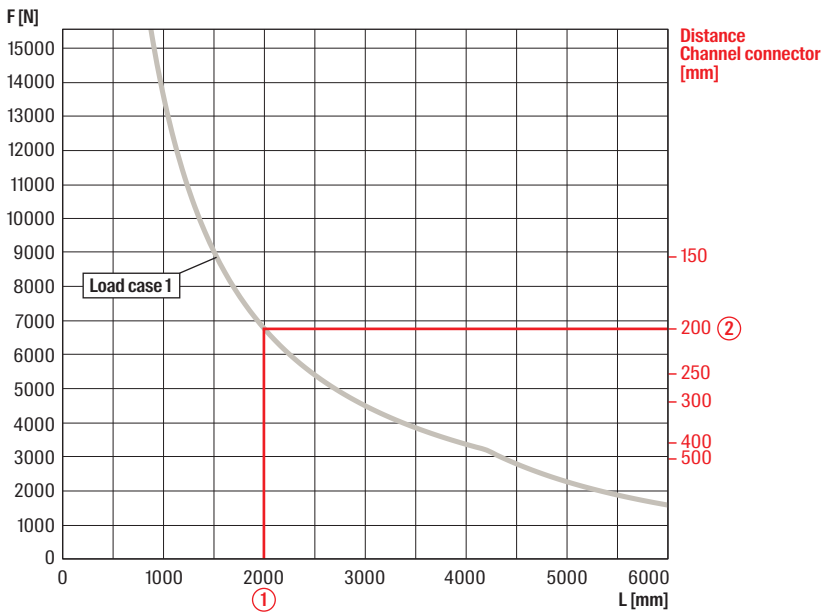

- ① Length of channel, i.e. 2000 mm for loadcase 1 (single load centric)
- ② Distance of channel connector (for intermediate values use the lower value)

Load case 1

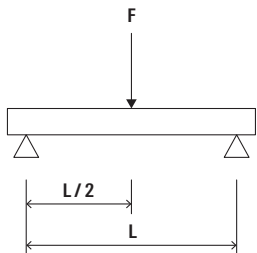

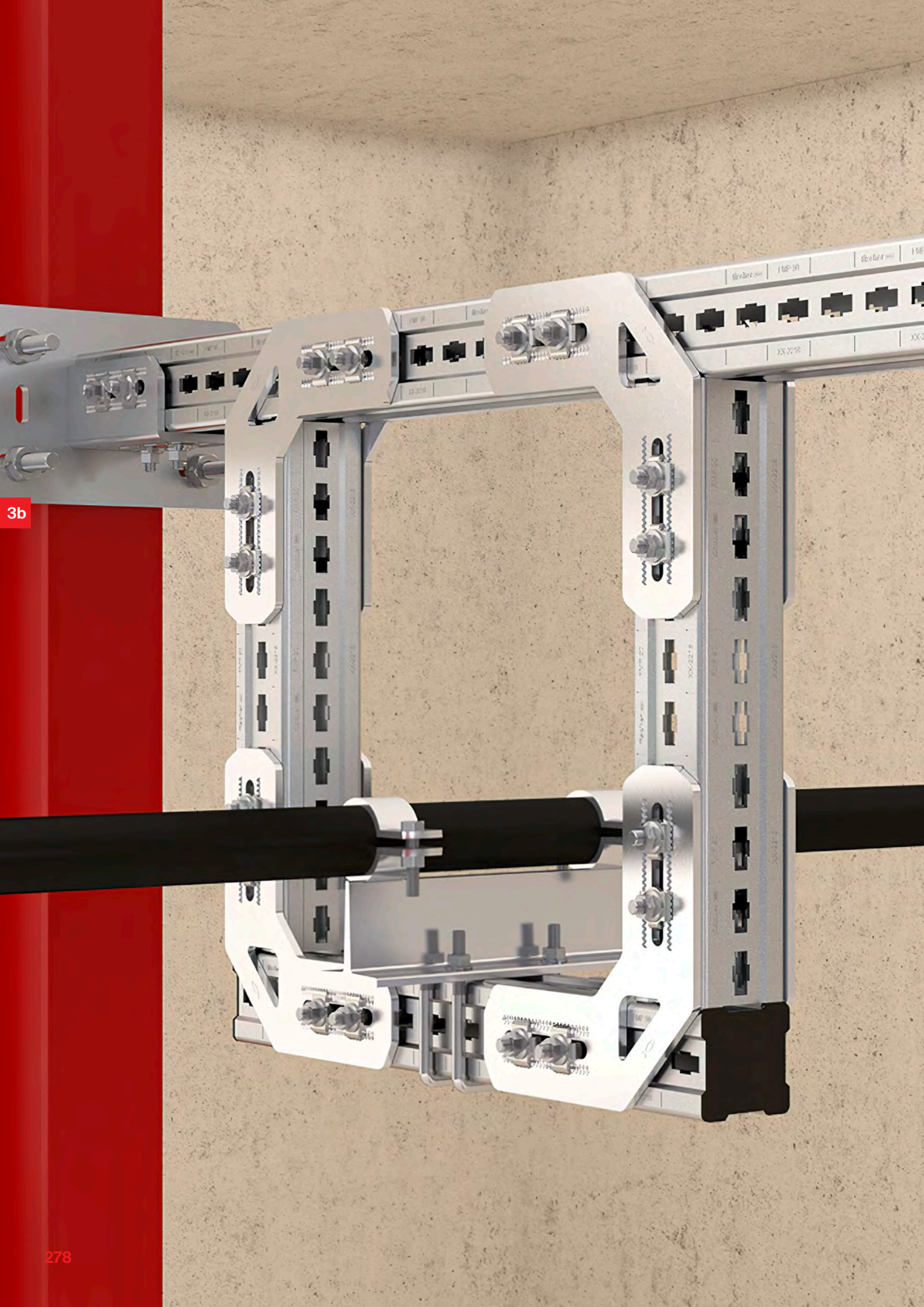















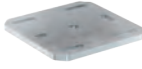







3b

3b

Massive channel system FMS

Massive profile FMP	280	
Channel connector FMPC	284	
Cantilever FMC	286	
End cap FMEC	289	
Hammer-head push connector FMHB	290	
Connecting element FMCE	294	
Connecting element FMCE-L short	292	
Saddle flange FMSF	296	
Base plate FMSF BP	295	
Variable bracket FMVB	298	
Beam clamp FMBC	300	
Beam clamp FMBC M12 and M16	302	
Flat fitting FMFF 90°	304	
Mounting angle FMA 3 and FMA 4	306	
Mounting angle FMA	308	
Connecting element FMUF	310	

Fix point U-bolt FMFS UB	312	
Pipe shoe sliding element FMFS	314	
Fix-point U-bolt FMFS S and M	316	
Pipe shoe FMPS	318	
Massive pipe clamp FMFSC	322	
Massive U-bolt FMPSU	324	

3b

Massive profile FMP

The efficient fixing solution for heavy-duty installations



Frame construction

Applications

- Secure fastening of heavy duty pipelines
- Safe construction of solid supporting structures

Advantages

- The clearly arranged product range of profiles and construction elements enables on-site assembly without prefabrication and thus considerably reduces costs and time.
- The fischer solid rail profiles can be square cut, thus reducing waste and material costs.
- The construction with the fischer solid rail system FMS also generates a fixing basis for dynamic loads and makes the system universally applicable.
- The hot-dip galvanised product range guarantees on-site processing without subsequent coating speeding the assembly process sustainably.
- The thick coating of the hot-dip galvanised version is suitable for outdoor installations and in corrosive environments.

Properties

- Material FMP: Steel S355MC (material no. 1.0976) acc. to DIN EN 10149-2
- Galvanisation: Hot-dip galvanised, min. 75 µm, acc. to DIN EN ISO 1461

3b

Technical data

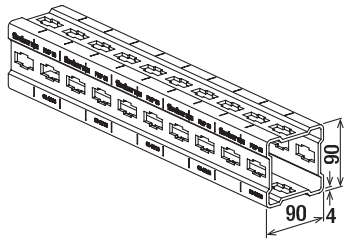

FMP 90

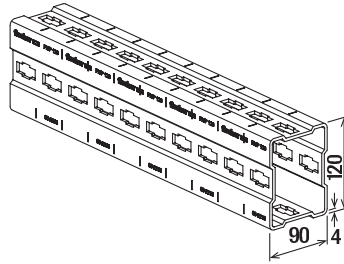

FMP 120

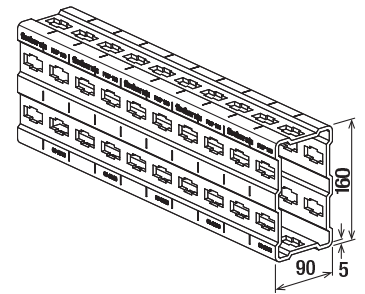

FMP 160

Item	Item No.	Length	Width	Height	Profil weight	Profile cross section	Thickness	Sales unit
		L [mm]	B [mm]	H [mm]				
FMP 90 3m	547795	3000	90	90	9.68	10.97	4	1
FMP 90 6m	547796	6000	90	90	9.68	10.97	4	1
FMP 120 3m	547797	3000	90	120	11.85	13.37	4	1
FMP 120 6m	547798	6000	90	120	11.85	13.37	4	1
FMP 160 6m	547799	6000	90	160	16.86	18.91	5	1
FMP 160 8m	547800 ¹⁾	8000	90	160	16.86	18.91	5	1

1) Delivery time on request.

3b

Loads

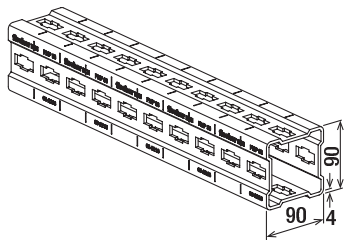

FMP 90

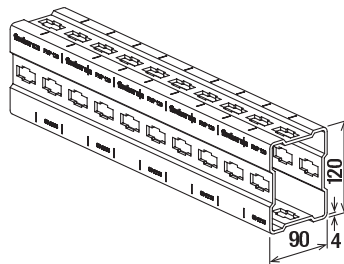

FMP 120

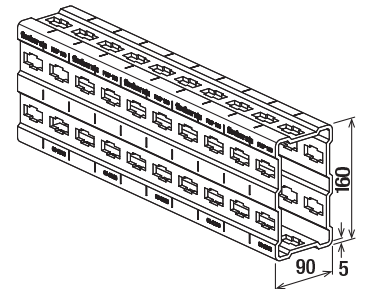

FMP 160

Item	Item No.	Yield strength	Rec. tensile stress	Rec. shear stress	Moment of inertia	Moment of inertia	Section modulus	Section modulus	Radius of gyration	Radius of gyration	Torsional moment of inertia	Torsional section modulus
		f_{yk} [kN/cm ²]	σ_{zul}^* [kN/cm ²]	τ_{zul}^* [kN/cm ²]	I_y [cm ⁴]	I_z [cm ⁴]	W_y [cm ³]	W_z [cm ³]	i_y [cm]	i_z [cm]	I_t [cm ⁴]	W_t [cm ³]
FMP 90 3m	547795	35.5	25.36	14.64	133.08	133.08	29.57	29.57	3.48	3.48	198.86	52.55
FMP 90 6m	547796	35.5	25.36	14.64	133.08	133.08	29.57	29.57	3.48	3.48	198.86	52.55
FMP 120 3m	547797	35.5	25.36	14.64	272.09	177.48	45.35	39.44	4.51	3.64	328.80	73.19
FMP 120 6m	547798	35.5	25.36	14.64	272.09	177.48	45.35	39.44	4.51	3.64	328.80	73.19
FMP 160 6m	547799	35.5	25.36	14.64	645.39	247.29	80.67	54.95	5.84	3.62	583.59	119.31
FMP 160 8m	547800 ¹⁾	35.5	25.36	14.64	645.39	247.29	80.67	54.95	5.84	3.62	583.59	119.31

1) Delivery time on request.

* The recommended stress is calculated acc. EN 1993; $\sigma_{rec} = f_{yk} / (\gamma_L \cdot \gamma_{M0})$ with $\gamma_L = 1.4$ and $\gamma_{M0} = 1.0$.

Simply supported beam with single load at L/2

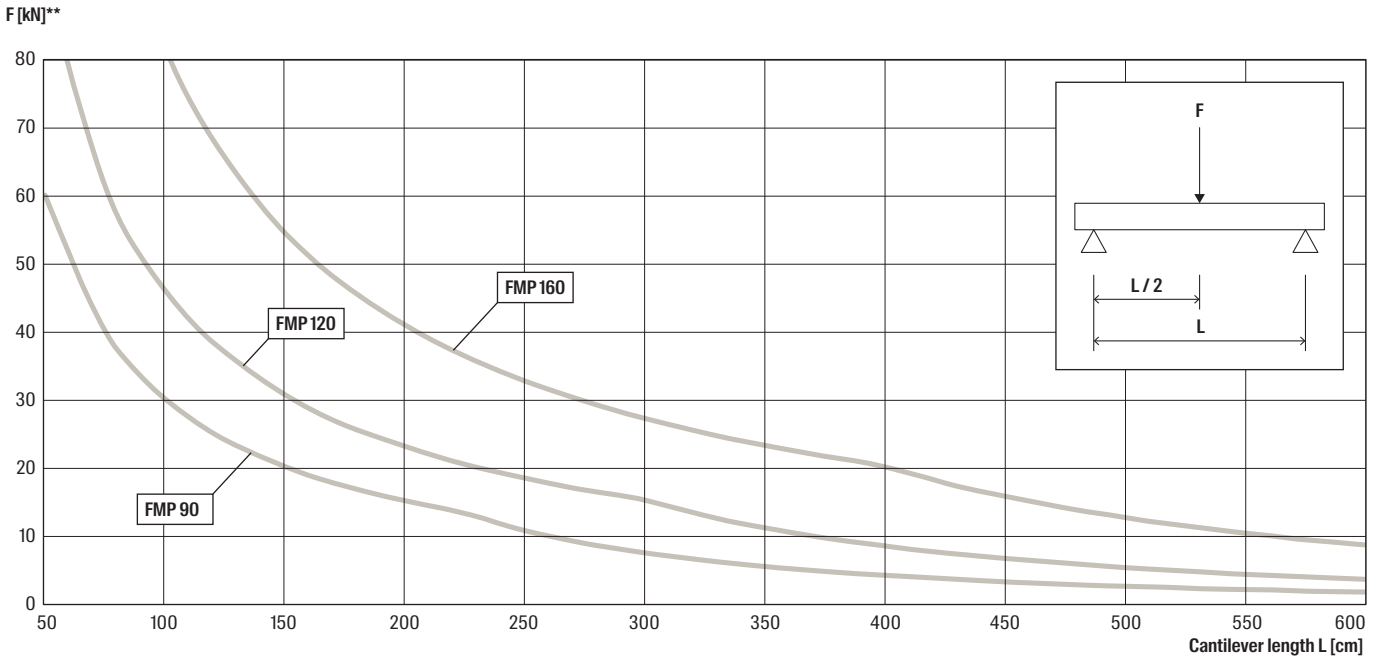

** The permissible stress is calculated acc. EN 1993; $\sigma_{rec} = f_{yk} / (\gamma_L \cdot \gamma_{M0})$ with $\gamma_L = 1,4$ and $\gamma_{M0} = 1,0$. Lower value of permissible stress (shear, bending or combined) or max. deflection ($L/200$) is decisive

3b

Simply supported beam with two single loads at L/3

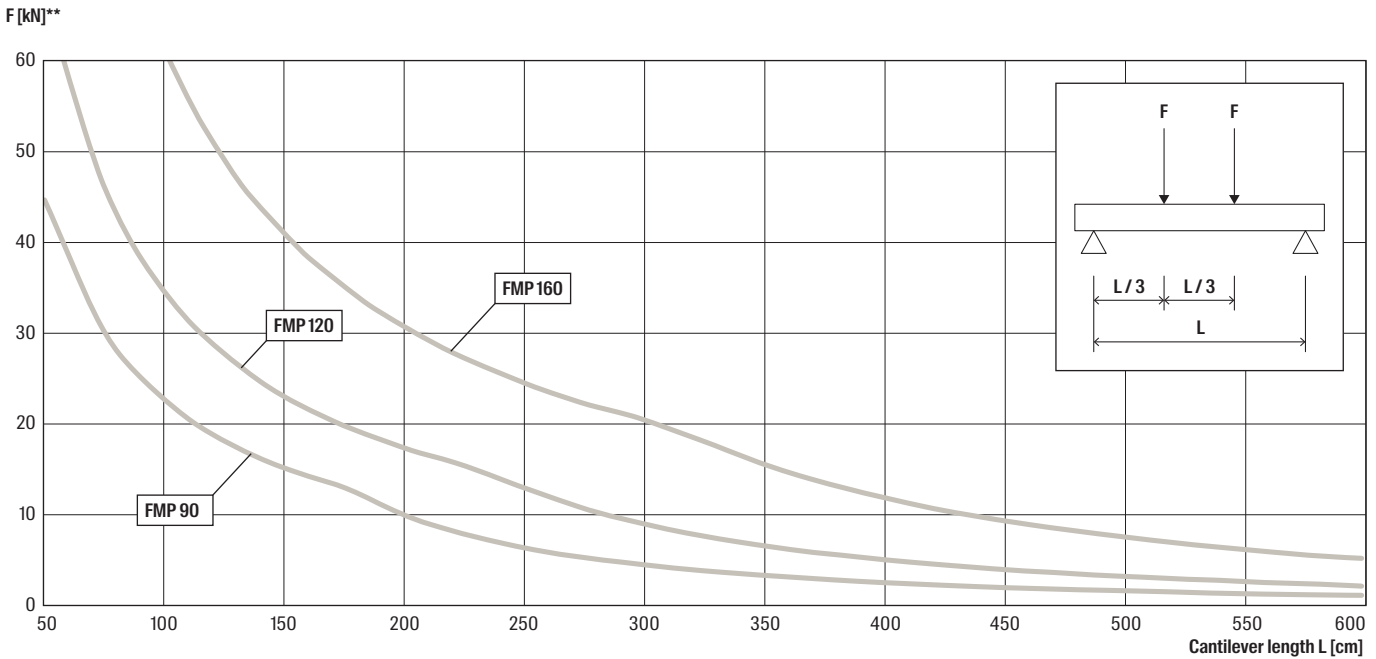

** The permissible stress is calculated acc. EN 1993; $\sigma_{rec} = f_{yk} / (\gamma_L \cdot \gamma_{M0})$ with $\gamma_L = 1,4$ and $\gamma_{M0} = 1,0$. Lower value of permissible stress (shear, bending or combined) or max. deflection ($L/200$) is decisive

Simply supported beam with three single loads at L/4

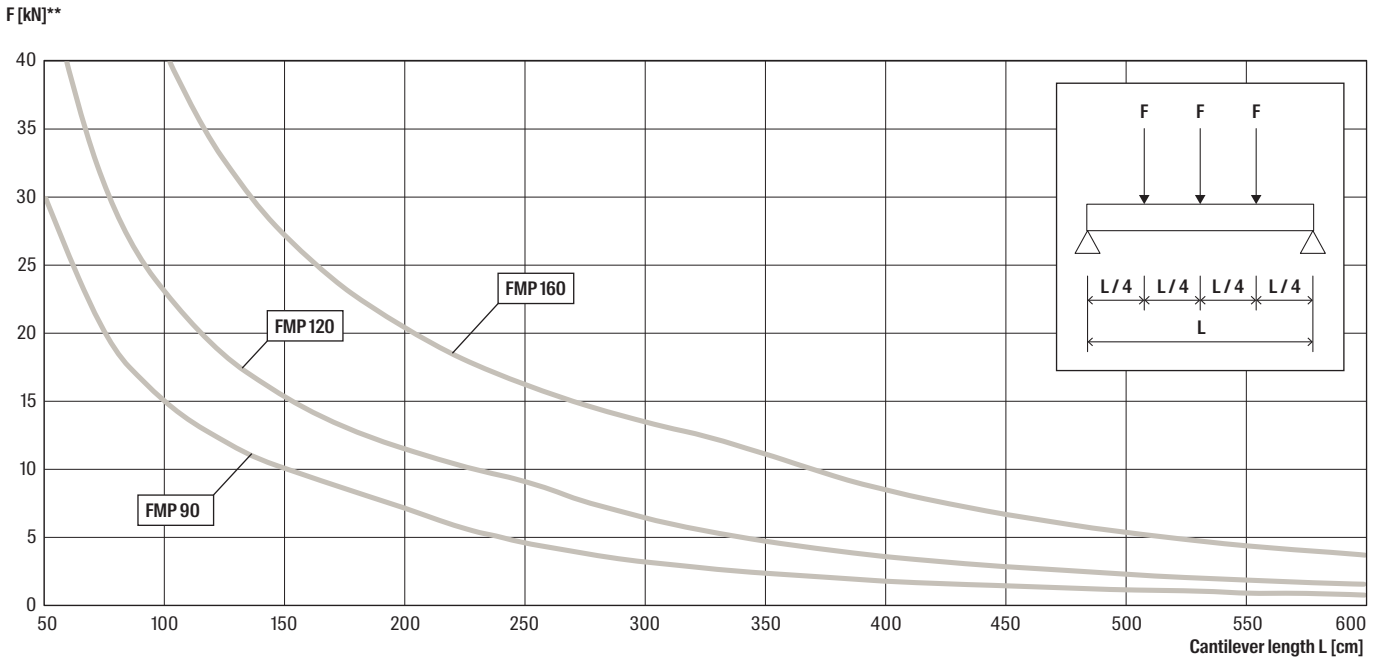

** The permissible stress is calculated acc. EN 1993; $\sigma_{rec} = f_{yk} / (\gamma_L \cdot \gamma_{M0})$ with $\gamma_L = 1,4$ and $\gamma_{M0} = 1,0$. Lower value of permissible stress (shear, bending or combined) or max. deflection ($L/200$) is decisive

3b

Uniformly distributed load $F_{rec} = q_{rec} \times L$

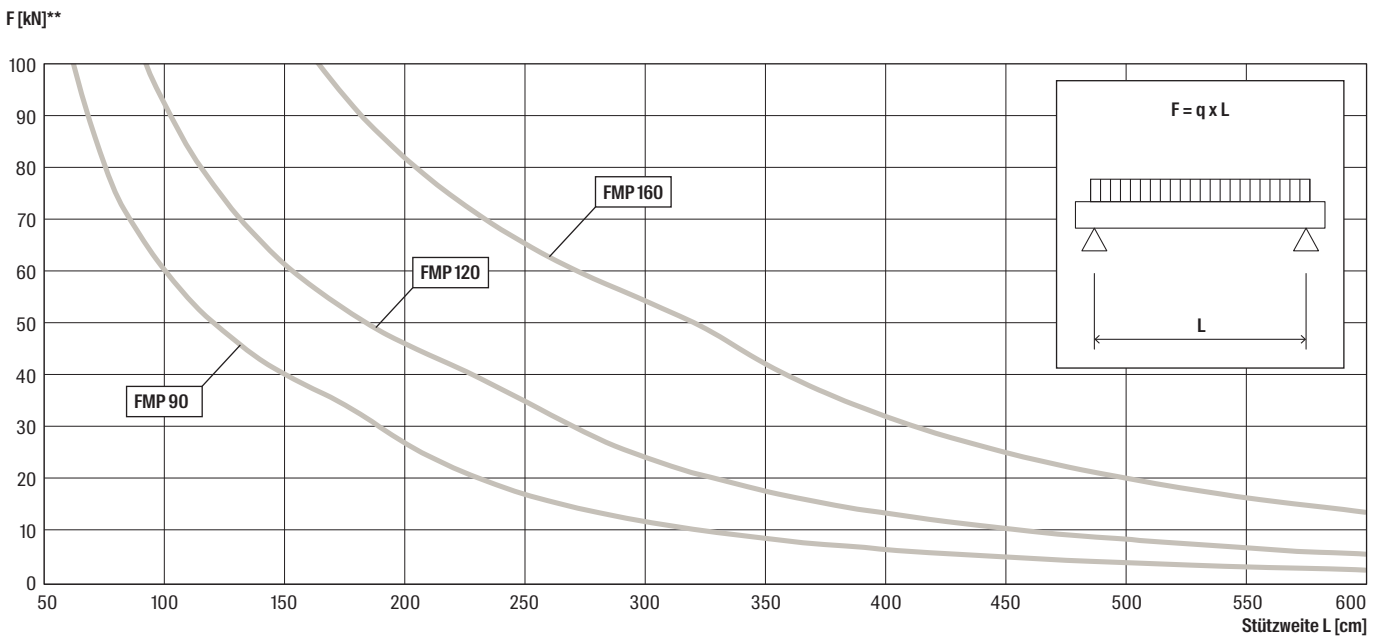

** The permissible stress is calculated acc. EN 1993; $\sigma_{rec} = f_{yk} / (\gamma_L \cdot \gamma_{M0})$ with $\gamma_L = 1,4$ and $\gamma_{M0} = 1,0$. Lower value of permissible stress (shear, bending or combined) or max. deflection ($L/200$) is decisive

Channel connector FMPC

Optimum connection and fastening of FMP massive profiles



Profil connection to steel structure

Applications

- Connecting and aligning massive profiles
- FMPC usable for FMP 90 and FMP120

Advantages

- The FMPC channel connector enables the connection of the sizes 90 and 120 of the FMP massive profiles for the perfect alignment of profile.
- All FMPC profile connectors enable the connection by means of simple screwing through for a fast and clean mounting.
- FMPC 90, 120 and 160 profile connectors allow a stiff connection of profiles and high load possibilities.

Properties

- Material FMPC: Steel S420MC (Material no. 1.0980) acc. to DIN EN 10149-2
- Material FMPC 90, 120, 160: steel S355 JR (material no. 1.0045) acc. to EN 10025-2
- Galvanisation: Hot-dip galvanised, min. 55 µm, acc. to DIN EN ISO 1461
- Material screw: steel grade 8.8

Installation FMPC

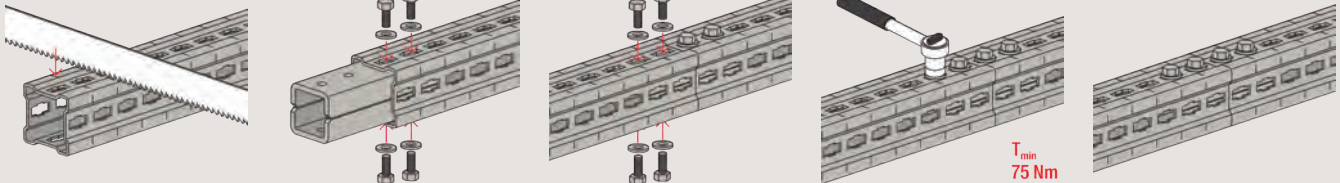

Installation FMPC 90/120/160

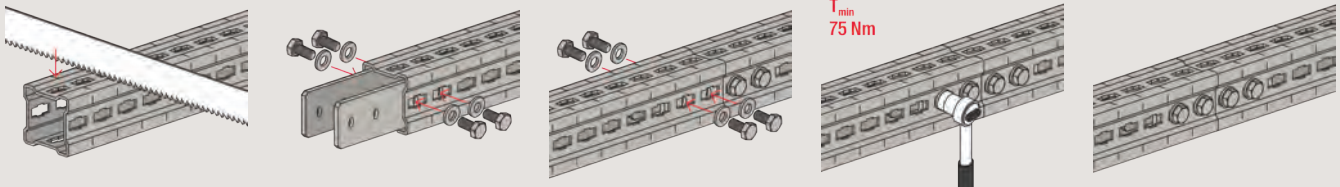

Technical data

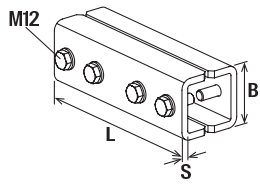

FMPC

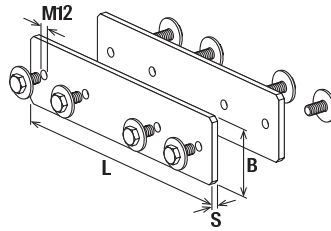

FMPC 90

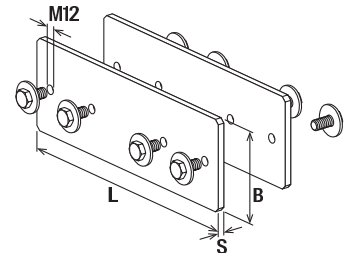

FMPC 120

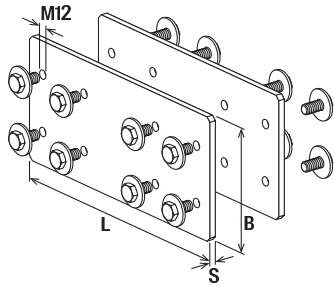

FMPC 160

Item	Item No.	Length L [mm]	Width B [mm]	Thread Ø x length [mm]	Thickness S [mm]	Sales unit [pcs]
FMPC	547801	220	72	M 12	8	2
FMPC 90	554236	320	81	M 12	8	5
FMPC 120	554237	320	111	M 12	8	2
FMPC 160	554238	320	150	M 12	8	2

3b

Cantilever FMC

Mounting profiles with welded base plate for fastening heavy duty pipelines



Profil traverse to steel structure



Supported cantilever

Applications

- Simple and safe fixing of heavy duty pipelines along the wall

Advantages

- The graduated length assortment of the FMC cantilever arms allows an optimal adaptation to the respective application.
- The stable base plate of the cantilever provides a secure hold for a load-bearing construction.
- The completely hot-dip galvanised product range guarantees on-site processing without subsequent coating and simplifies and accelerates the assembly process sustainably.

Properties

- Material base plate: Steel S235JR (material no. 1.0038) acc. to DIN EN 10025-2
- Material profile: Steel S355MC (material no. 1.0976) acc. to DIN EN 10149-2
- Galvanisation: Hot-dip galvanised, min. 75 µm, acc. to DIN EN ISO 1461

3b

Technical data

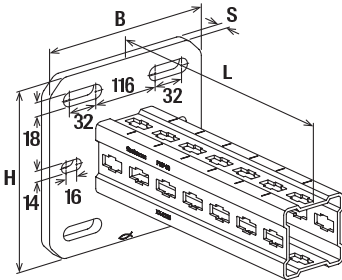

FMC 90

Item	Item No.	Length L [mm]	Width B [mm]	Height H [mm]	Thickness S [mm]	Sales unit [pcs]
FMC 90-500	547802	500	230	230	15	1
FMC 90-750	547803	750	230	230	15	1
FMC 90-1000	547804	1000	230	230	15	1
FMC 90-1500	547805	1500	230	230	15	1

Loads

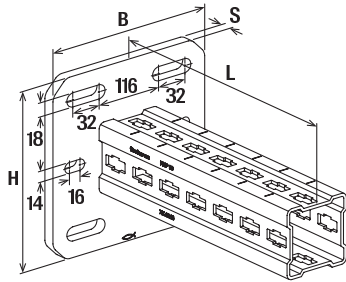

FMC 90

Item	Item No.	Max. recommended static load load case 1	Max. recommended static load load case 2	Max. recommended static load load case 3
		F_{rec} [kN]	F_{rec} [kN]	F_{rec} [kN]
FMC 90-500	547802	24.60	12.30	24.60
FMC 90-750	547803	16.40	8.20	16.40
FMC 90-1000	547804	12.30	5.60	12.30
FMC 90-1500	547805	7.80	2.40	7.80

Load case 1

F [kN]**

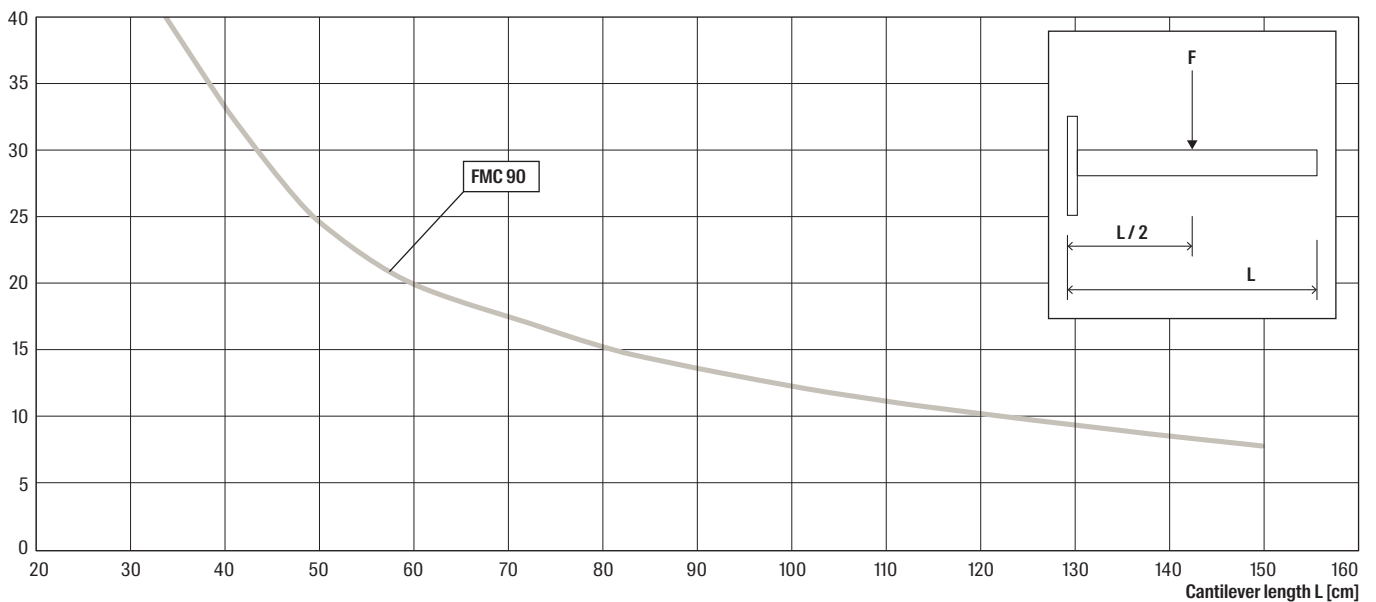

** The permissible stress is calculated acc. EN 1993; $\sigma_{rec} = f_{yk} / (\gamma_L \cdot \gamma_{M0})$ with $\gamma_L = 1.4$ and $\gamma_{M0} = 1.0$. Lower value of permissible stress (shear, bending or combined) or max. deflection ($L/150$) is decisive

3b

Load case 2

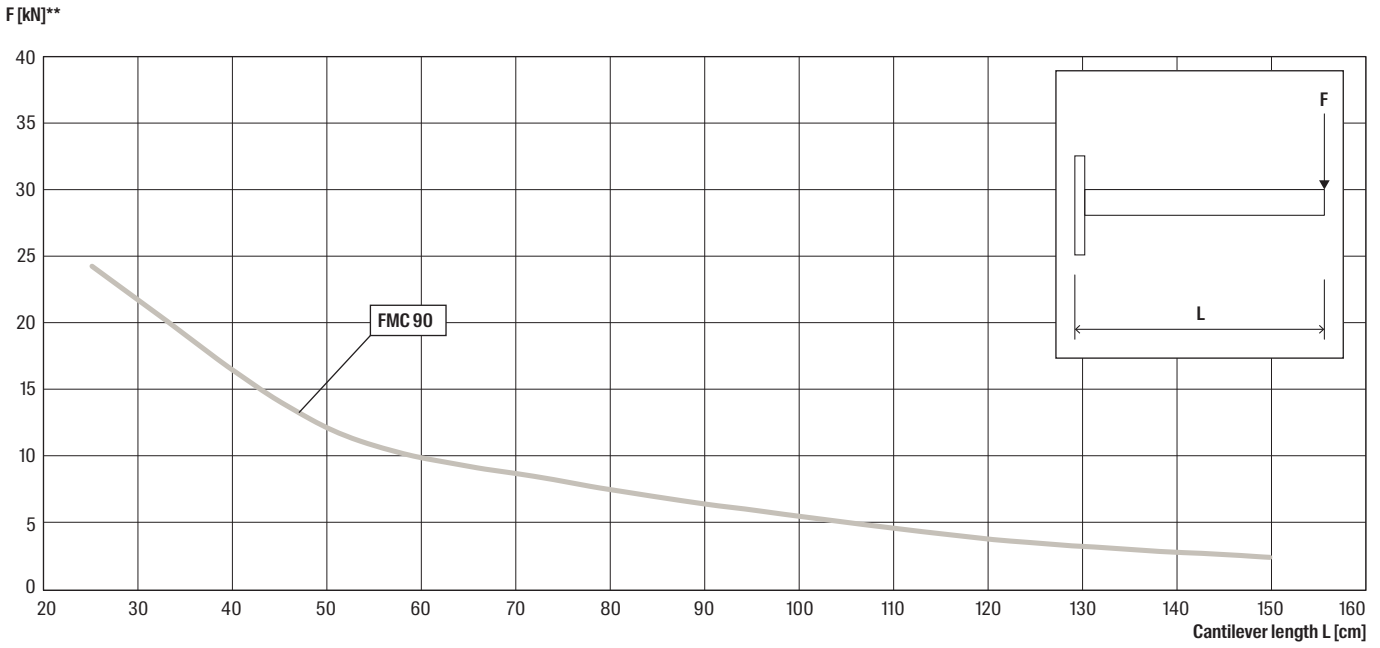

** The permissible stress is calculated acc. EN 1993; $\sigma_{rec} = f_{yk} / (\gamma_L \cdot \gamma_{M0})$ with $\gamma_L = 1,4$ and $\gamma_{M0} = 1,0$. Lower value of permissible stress (shear, bending or combined) or max. deflection ($L/150$) is decisive

3b

Load case 3

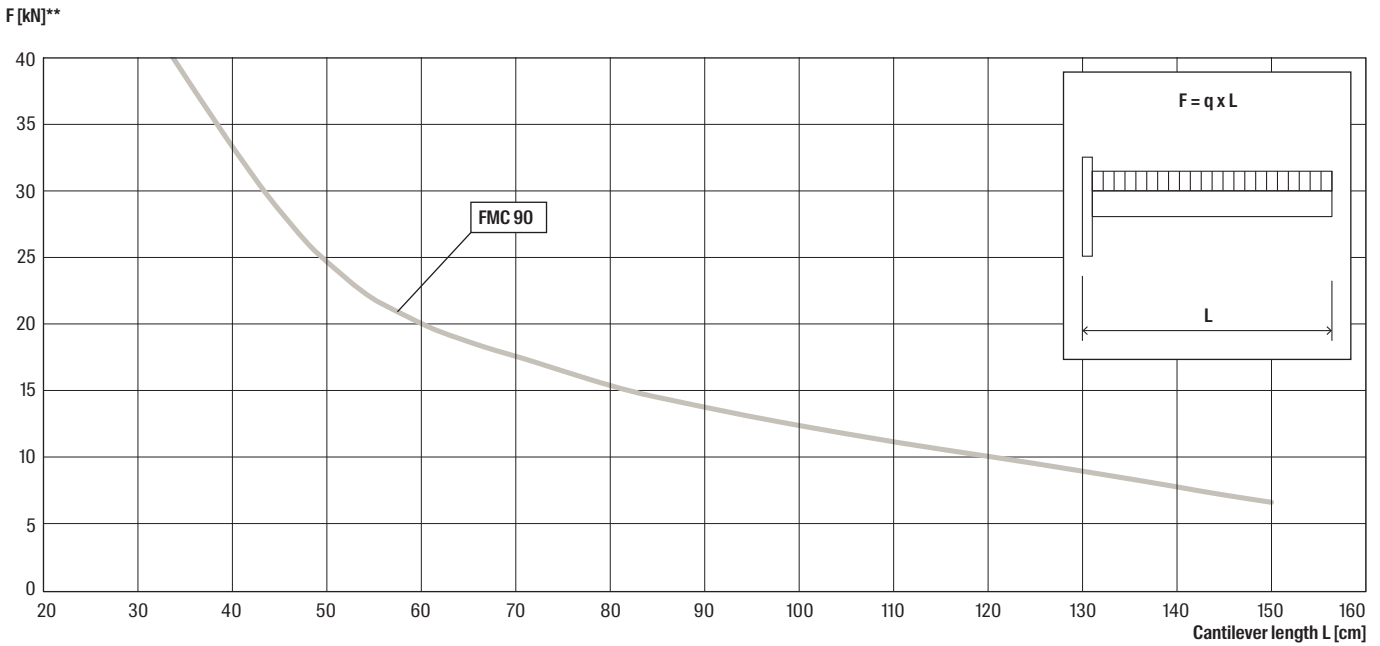

** The permissible stress is calculated acc. EN 1993; $\sigma_{rec} = f_{yk} / (\gamma_L \cdot \gamma_{M0})$ with $\gamma_L = 1,4$ and $\gamma_{M0} = 1,0$. Lower value of permissible stress (shear, bending or combined) or max. deflection ($L/150$) is decisive

End cap FMEC

The clip-on and accurately shaped end for the FMP mounting profile



U-rack construction with flat fittings

Applications

- Closing of profile end

Advantages

- Suitable for FMP 90, 120 and 160 mounting profiles and cantilever arms FMC.

Properties

- Material: PP Polypropylen, colour black

3b

Technical data



FMEC 90

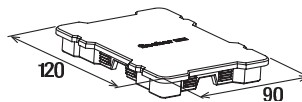

FMEC 120

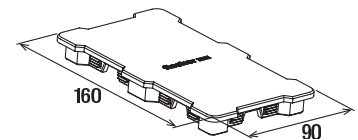

FMEC 160

Item	Item No.	For profile	Sales unit
			[pcs]
FMEC 90	547806	FMP 90	100
FMEC 120	547807	FMP 120	60
FMEC 160	547808	FMP 160	40

Hammer-head push connector FMHB

Universal connector for FMP massive profile and construction elements



U-rack construction

Applications

- Connection of construction elements and assembly profiles by means of plug-in connectors
- Usable for dynamic loads with the security nut FMSB MU M12
- Install the FMSB MU M12 hand-tight + 1/4 turn

Advantages

- The unique hammer-head push connector allows easy modification of the construction and thus ensures fast design changes.
- The special design of the hammer-head push connector allows simple retrofitting to existing structures.
- The flexible hammer-head push connector in combination with the solid construction elements allows easy adjustment during installation and makes the alignment of a pipeline route simple and quick.
- The FMHB hammer-head push connector as a prefabricated connecting element enables safe and error-free assembly of the construction elements.

Properties

- Material: Steel S235JR (Material no. 1.0038) acc. to DIN EN 10025-2
- Galvanisation: Hot-dip galvanised, min. 55 µm, acc. to DIN EN ISO 1461
- Material for hammer-head bolt: Steel 8.8, similar to 1.0503 C45
- Material plastic cage: polypropylene PP, item number 11400, Color black
- Material safety nut: GB/T 805-1988 according to DIN 7967

Installation FMHB

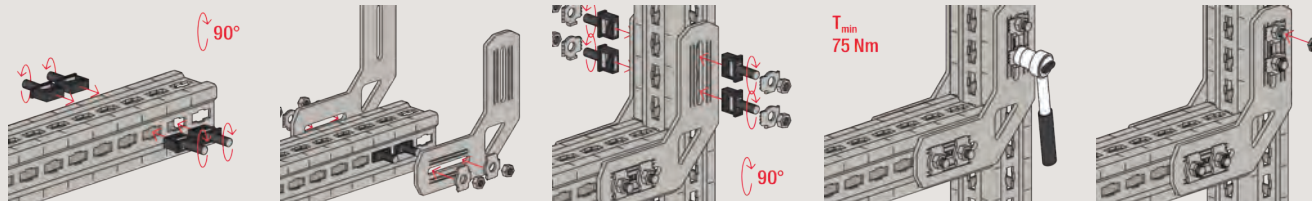

Technical data

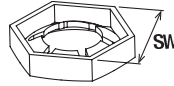
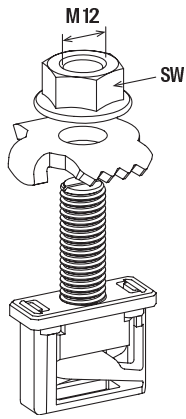

FMHB

FMSB MU M12

Item	Item No.	Thread Ø x length [mm]	Width across nut SW [mm]	Sales unit [pcs]
FMHB	547809	M 12	18	100
FMSB MU M12	547810	M 12	19	100

Connecting element FMCE-L

Tailor-made fixing to massive profiles FMP



Profil traverse to steel structure

Applications

- Fixing of pipes using threaded rods or set screws

Advantages

- The L-shaped connecting elements allow pipe clamps, U-bolts and elements with base plates to be easily connected.
- The L-connector FMCE-L can easily be attached to all 3 sizes of the FMP mounting profile after the FMHB hammer-head connector has been pre-positioned.

Properties

- Material: Steel S235JR (material no. 1.0038) acc. to DIN EN 10025-2
- Galvanisation: Hot-dip galvanised, min. 55 µm, acc. to DIN EN ISO 1461

Installation FMCE-L short

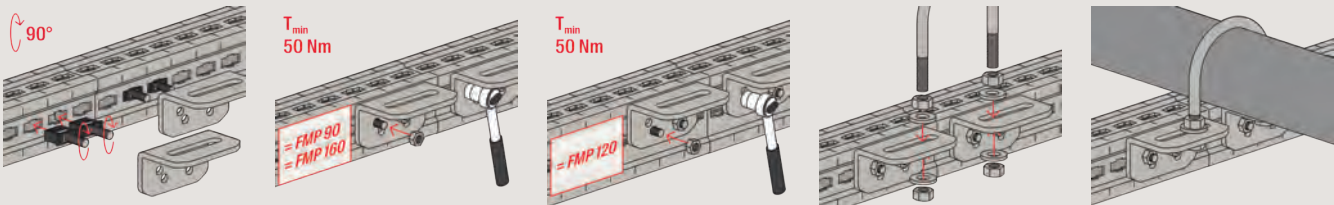

Technical data

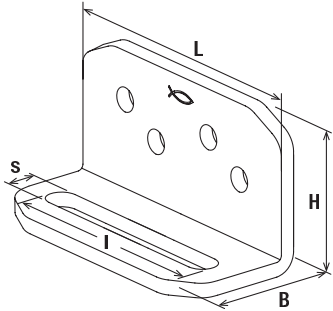
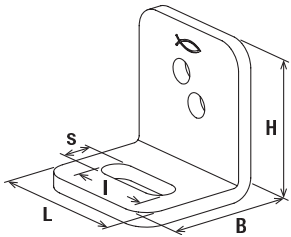

FMCE-L short

FMCE-L

Item	Item No.	Slot l x s [mm]	Length L [mm]	Width B [mm]	Height H [mm]	Sales unit [pcs]
FMCE-L short M12	554239	50 x 13,5	80	71	84	20
FMCE-L short M16	554240	50 x 17,5	80	71	84	20
FMCE-L short M20	554241	50 x 22	80	71	84	20
FMCE-L M12	547818	100 x 13,5	130	71	84	10
FMCE-L M16	547819	100 x 17,5	130	71	84	10
FMCE-L M20	547820	100 x 22	130	71	84	10

3b

Connecting element FMCE

Tailor-made fixing to massive profiles FMP



Pipe clamp connection to profile

Applications

- Fixing of pipes using threaded rods

Advantages

- The U-shaped connecting elements allow an easy connection of pipe clamps.
- Supplying the connecting element as a set with the necessary screw, hexagonal nut and washer ensures error-free installation.

Properties

- Material: Steel S235JR (material no. 1.0038) acc. to DIN EN 10025-2
- Galvanisation: Hot-dip galvanised, min. 55 µm, acc. to DIN EN ISO 1461
- Material screw: steel grade 8.8

3b

Installation FMCE

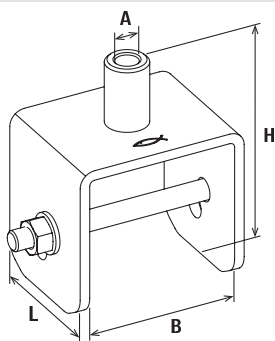
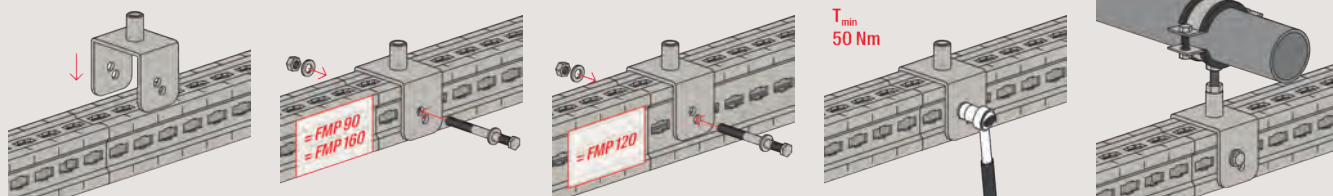

FMCE

Item	Item No.	Thread M	Length L [mm]	Width B [mm]	Height H [mm]	Sales unit [pcs]
FMCE M12/M16	547815	M12 / M16	80	91	134	10
FMCE 1/2"	547816	1/2"	80	91	134	10
FMCE 3/4"	547817	3/4"	80	91	134	10

Base plate FMSF BP

Optimum connection and fastening saddle flange and cantilever to steel- and concrete beams

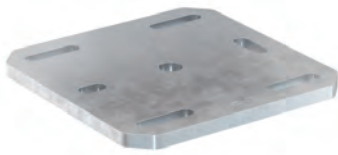

Connection to steel support

Applications

- For solid connections between the massive profile and building structures

Advantages

- The clever design, and size graduations of the FMSF BP base plates, offer optimum fixing ensuring and secure hold.
- The FMSF BP base plate is identical in construction to the base plates of the FMSF saddle flanges and enables simple connection by means of threaded rods for secure mounting on steel beams.

Properties

- Material: Steel S235JR (material no. 1.0038) acc. to DIN EN 10025-2
- Galvanisation: Hot-dip galvanised, min. 55 µm, acc. to DIN EN ISO 1461

3b

Technical data

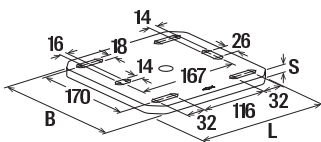

FMSF BP S

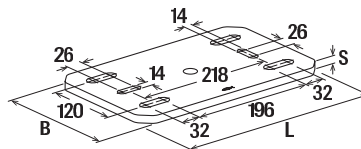

FMSF BP M

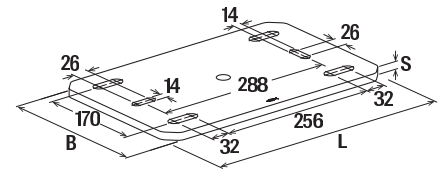

FMSF BP L

Item	Item No.	For steel beam width	Length	Width	Thickness	Sales unit
		[mm]	L [mm]	B [mm]	S [mm]	[pcs]
FMSF BP S	547829	100 - 160	230	230	12	1
FMSF BP M	547830	180 - 240	330	200	12	1
FMSF BP L	547831	240 - 300	400	250	12	1

Saddle flange FMSF

Optimum connection and fastening of FMP massive profiles

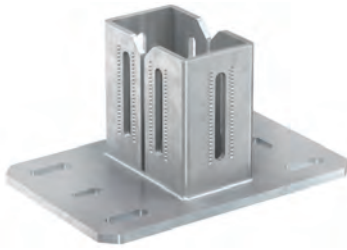

U-rack at profile traverse

Applications

- For solid connections between the channel and building structures

Advantages

- The design of the FMSF saddle flange enables fast and secure mounting by fitting inside the profile.
- The clever design and dimensions of the base plate of the FMSF saddle flange offers the optimum load level depending on the construction and ensures a secure hold.

Properties

- Material: Steel S235JR (material no. 1.0038) acc. to DIN EN 10025-2
- Galvanisation: Hot-dip galvanised, min. 55 µm, acc. to DIN EN ISO 1461

Installation FMSF

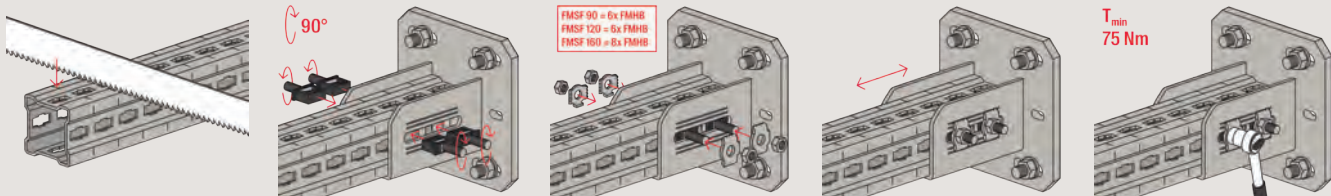

Technical data

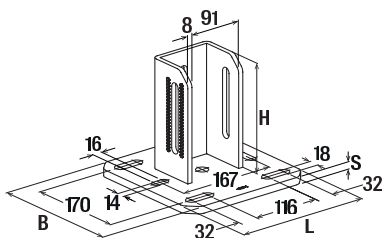

FMSF 90S

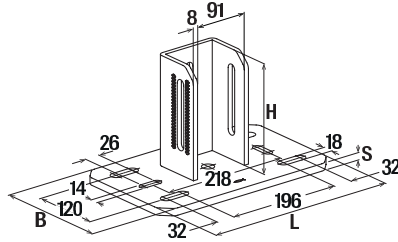

FMSF 90M

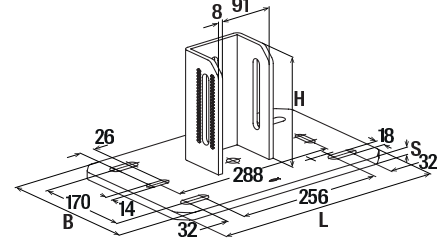

FMSF 90L

Item	Item No.	For profile	For steel beam width [mm]	Length L [mm]	Width B [mm]	Height H [mm]	Thickness S [mm]	Sales unit [pcs]
FMSF 90S	547821	FMP 90	100 - 160	230	230	180	12	1
FMSF 90M	547822	FMP 90	180 - 240	330	200	180	12	1
FMSF 90L	547823	FMP 90	240 - 300	400	250	180	12	1

Technical data

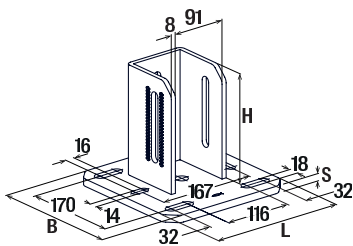

FMSF 120S

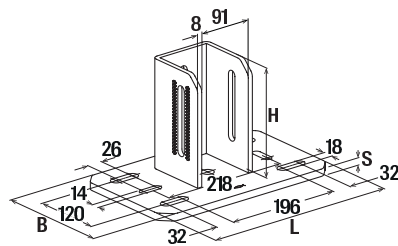

FMSF 120M

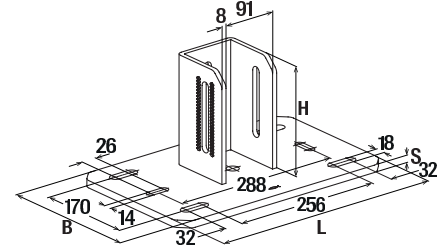

FMSF 120L

Item	Item No.	For profile	For steel beam width [mm]	Length L [mm]	Width B [mm]	Height H [mm]	Thickness S [mm]	Sales unit [pcs]
FMSF 120S	547824	FMP 120	100 - 160	230	230	180	12	1
FMSF 120M	547825	FMP 120	180 - 240	330	200	180	12	1
FMSF 120L	547826	FMP 120	240 - 300	400	250	180	12	1

Technical data

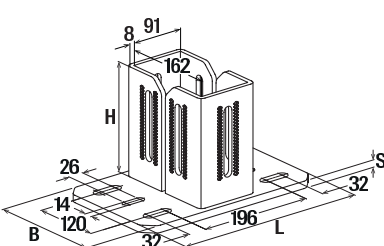

FMSF 160M

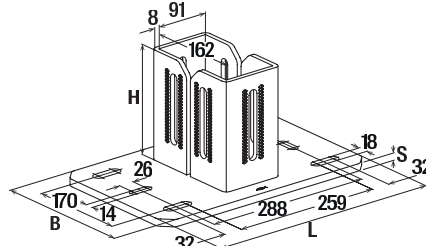

FMSF 160L

Item	Item No.	For profile	For steel beam width [mm]	Length L [mm]	Width B [mm]	Height H [mm]	Thickness S [mm]	Sales unit [pcs]
FMSF 160M	547827	FMP 160	180 - 240	330	200	180	12	1
FMSF 160L	547828	FMP 160	240 - 300	400	250	180	12	1

3b

Variable bracket FMVB

Variable connection of FMP massive profiles to each other and to the substrate



Supported cantilever

Applications

- Constructions of FMP massive profiles at an angle of 0° to 180°
- Mounting elements for the design of supporting structures with the FMP massive profiles
- Element for the stable construction of connections between channels and building structures

Advantages

- The variable construction elements allow stiffening or support of the profile construction at any angle and are therefore suited for versatile use.
- The stable design and the size graduation of the FMVB base plates offer the optimum fixing option depending on the construction and ensure a secure hold.
- The FMVB variable bracket with slot and grating to accommodate the toothed plate of the FMHB hammer-head push connector allows optimum adjustment of the supported profile for simple and safe installation.
- Supplying the FMVB articles as a set with the necessary screw, hexagonal nut and washer ensures error-free installation.

Properties

- Material: Steel S235JR (material no. 1.0038) acc. to DIN EN 10025-2
- Galvanisation: Hot-dip galvanised, min. 55 µm, acc. to DIN EN ISO 1461
- Material screw: steel grade 8.8

Installation FMVB

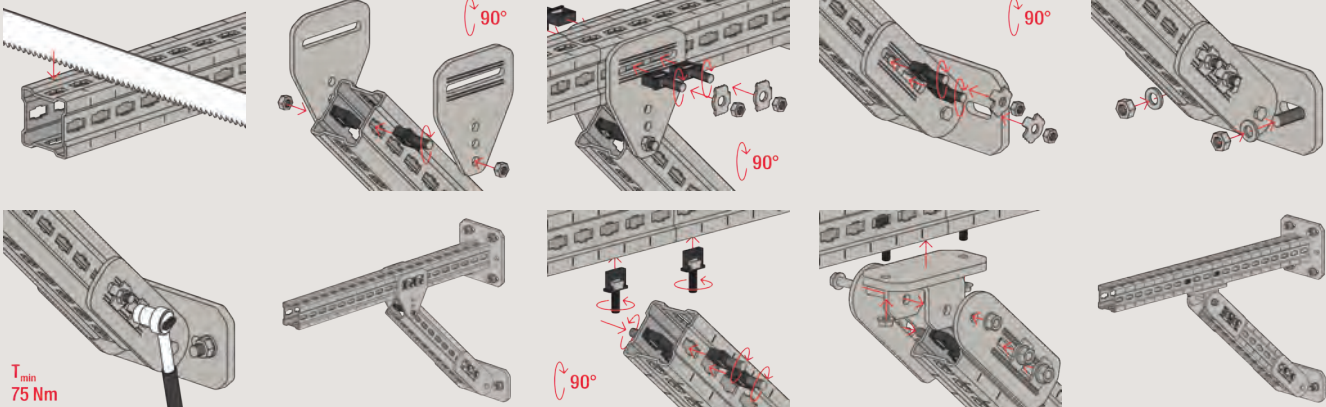

Technical data

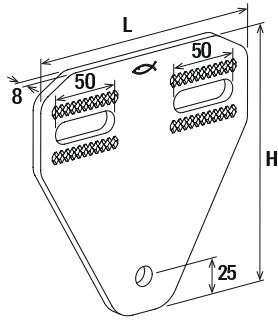

FMVB-P

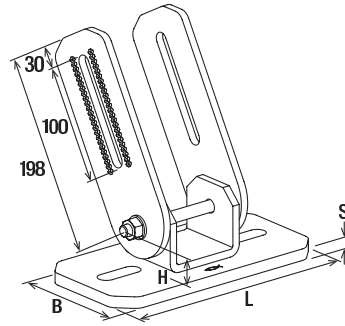

FMVB BP

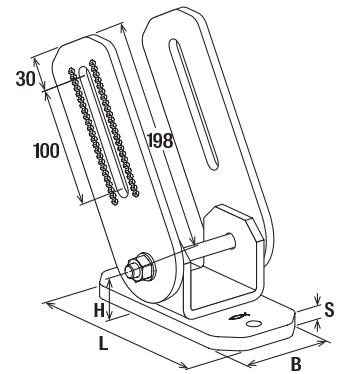

FMVB-P II

Item	Item No.	Length L [mm]	For steel beam width [mm]	Width B [mm]	Height H [mm]	Thickness S [mm]	Sales unit [pcs]
FMVB-P	547832	175	—	—	180	8	4
FMVB BP S	547833	250	100 - 160	125	40.5	12	2
FMVB BP M	547834	330	180 - 240	125	40.5	15	2
FMVB BP L	547835	400	240 - 300	125	40.5	15	2
FMVB-P II	554242	190	—	90	67	12	2

Beam clamp FMBC

Clamping bracket for fastening FMP massive profiles to steel beams



Profile fixing with beam clamp

Applications

- Attachment to the steel beam with two beam clamps on each side

Advantages

- The design of the FMBC beam clamp makes it possible to fasten to steel beams without drilling or welding.
- The large clamping range of the FMBC beam clamp allows it to be attached to all common beam flanges.
- The design of the FMBC beam clamp in the 3 matching bracket heights for the FMP massive profiles ensures fast mounting and easy moving of the profiles for adjustment.

Properties

- Material: Cast iron with ductile iron (QT450-10 (material no. 5.3107) acc. to EN 1563
- Material U-bolt: Steel S235JR (material no. 1.0038) acc. to DIN EN 10025-2
- Galvanisation: Hot-dip galvanised, min. 55 µm, acc. to DIN EN ISO 1461
- Material hexagon nut: Steel resistance class 8

Installation FMBC

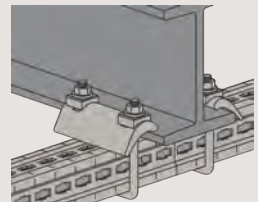
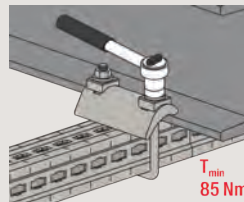
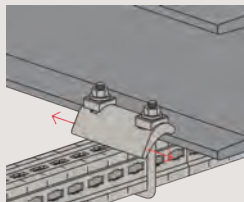
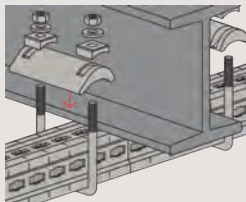
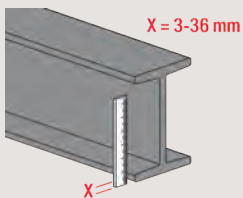

Technical data

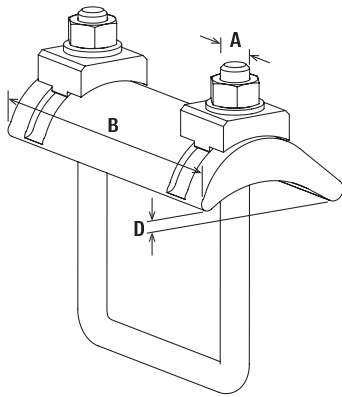

FMBC

Item	Item No.	For profile	Thread A	Width B [mm]	Clamping range D [mm]	Sales unit [pcs]
FMBC 90	547836	FMP 90	M 12	140	3 - 36	4
FMBC 120	547837	FMP 120	M 12	140	3 - 36	4
FMBC 160	547838	FMP 160	M 12	140	3 - 36	4

3b

Beam clamp FMBC M12 and M16

Efficient connection of base plates to steel beams without welding and drilling



Fixing with beam clamp

Applications

- Simple fixing by clamping the base plate to the steel beams
- For fixing FMSF S and FMSF BP S use FMBC M12. For FMS and FMSF BP M and L use FMBC M16.

Advantages

- The design of the FMBC beam clamp M12 and M16 makes it possible to fasten to steel beams without drilling or welding.
- The large clamping range of the FMBC beam clamp M12 and M16 allows it to be attached to all common beam flanges.
- The design of the FMBC beam clamp M12 and M16 in the 3 matching bracket heights for the FMP massive profiles ensures fast mounting and easy moving of the profiles for adjustment.

Properties

- Material: cast iron with ductile iron (QT450-10 (material no. 5.3107) acc. to EN 1563
- Galvanisation: Hot-dip galvanised, min. 55 µm, acc. to DIN EN ISO 1461
- Material screw: steel grade 8.8

Installation FMBC M

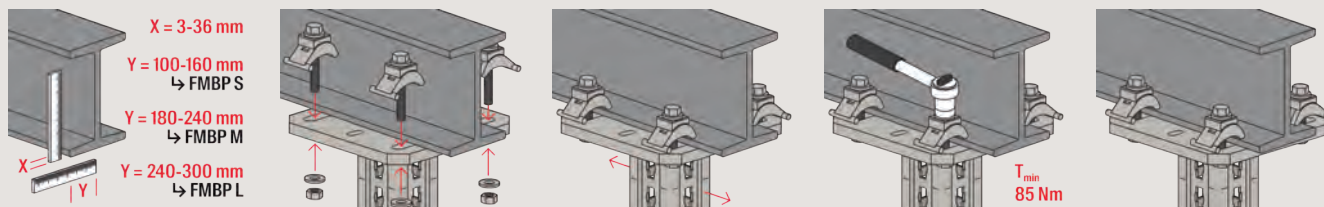

Technical data

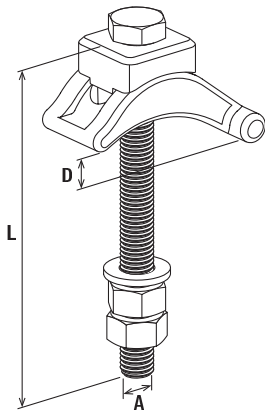

FMBC-M

Item	Item No.	Thread A	Length L [mm]	Clamping range D [mm]	Sales unit [pcs]
FMBC M12	547839	M 12	130	3 - 36	16
FMBC M16	547840	M 16	150	3 - 36	12

3b

Flat fitting FMFF 90°

Stable right-angled connection of FMP massive profiles to each other



U-rack construction with flat fittings

Applications

- Element for stable right-angled connection of massive profiles with 2 flat connectors on each

Vorteile

- The flat angle FMFF 90° is used in pairs and offers a high load capacity when connecting the FMP mounting profiles for the construction of massive applications.
- The design of the 90° flat angle FMFF with slotted holes and grating to accommodate the toothed plate of the FMHB hammer head connector allows optimum adjustment of the construction and simplifies the assembly process.

Properties

- Material: Steel S235JR (material no. 1.0038) acc. to DIN EN 10025-2
- Galvanisation: Hot-dip galvanised, min. 55 µm, acc. to DIN EN ISO 1461

Installation FMFF

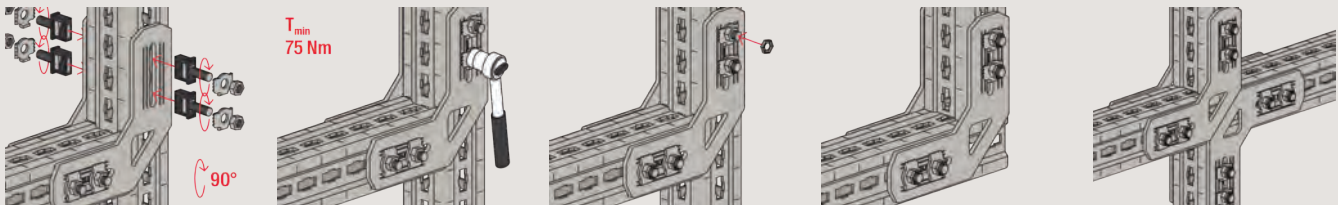

Technical data

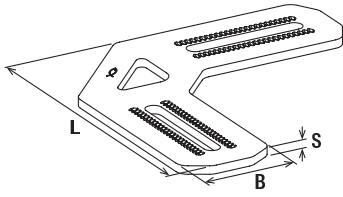

FMFF

Item	Item No.	Length L [mm]	Width B [mm]	Thickness S [mm]	Sales unit [pcs]
FMFF 90°	547841	282	90	8	1

3b

Mounting angle FMA 3 and FMA 4

The application-oriented connection of FMP massive profiles with each other

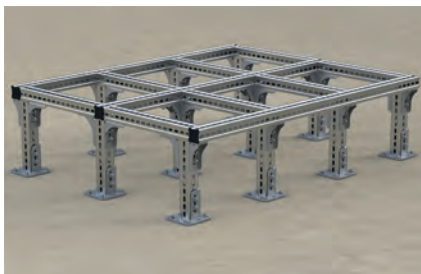

3D frame construction

Applications

- Connecting elements for multi-dimensional channel constructions

Advantages

- The different construction types of the mounting angle FMA 3 and FMA 4 enable an application oriented connection of the massive profiles FMP and make the construction possibilities even more flexible.
- The version of the mounting angle FMA with slotted holes and grating to accommodate the toothed plate of the hammer bolt connector FMHB enables the optimised adaption of the construction and simplifies the mounting process.

Properties

- Material: Steel S235JR (material no. 1.0038) acc. to DIN EN 10025-2
- Galvanisation: Hot-dip galvanised, min. 55 µm, acc. to DIN EN ISO 1461

Installation FMA 3

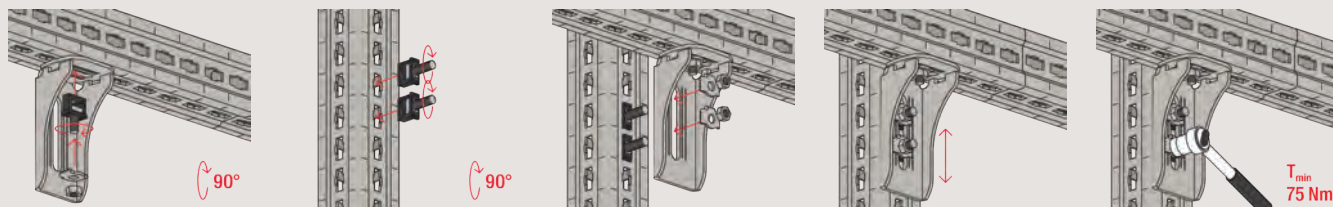

Installation FMA 4

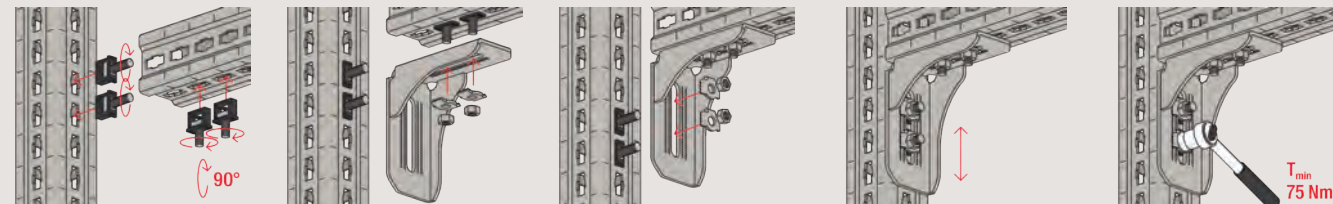

Technical data

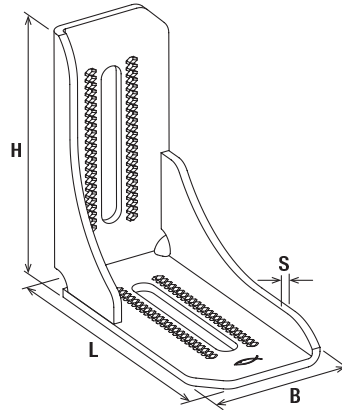
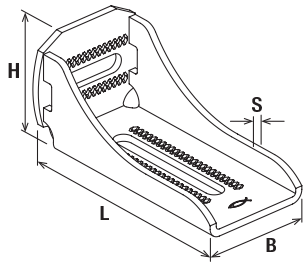

FMA 3

FMA 4

Item	Item No.	Length L [mm]	Width B [mm]	Height H [mm]	Thickness S [mm]	Sales unit [pcs]
FMA 3	547842	190	90	90	6	10
FMA 4	547843	190	90	190	6	8

Mounting angle FMA

The application-oriented connection of FMP massive profiles to built up racks



Frame constructions

Applications

- Mounting elements for the design of supporting structures with the FMP massive profiles

Advantages

- The different construction heights of the mounting angle FMA enable the application-oriented connection according to the 3 different construction heights of the massive profiles FMP.
- The version of the mounting angle FMA with slotted holes and grating to accommodate the toothed plate of the hammer bolt connector FMHB enables the optimized adaption of the construction and simplifies the mounting process.
- Supplying the FMA articles as a set with the necessary screws, hexagonal nuts and washers ensures error-free installation.

Properties

- Material: Steel S235JR (material no. 1.0038) acc. to DIN EN 10025-2
- Galvanisation: Hot-dip galvanised, min. 55 µm, acc. to DIN EN ISO 1461
- Material screw: steel grade 8.8

Installation FMA

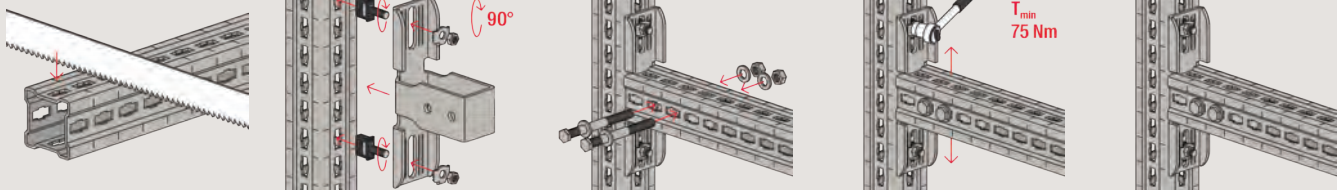

Technical data

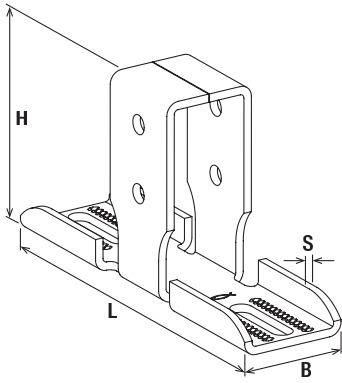

FMA 90

Item	Item No.	Length L [mm]	Width B [mm]	Height H [mm]	Thickness S [mm]	Sales unit [pcs]
FMA 90	547844	277.5	77.5	148	6	4
FMA 120	547845	277.5	77.5	148	6	4
FMA 160	547846	350	77.5	148	6	4

Connecting element FMUF

Simple bracket connection of FMP massive profiles to each other and to the substrate



Pendant cantilever fixed to traverse profil

Applications

- Stable construction of connections between channels and building structures for the push-through system
- Connecting elements for multi-dimensional channel constructions
- For a secure transverse force connection, 2 M12*130 bolts with M12 nuts can be used alternative, which are pushed through the round openings, whereby each bolt is guided through the adjacent openings.

Advantages

- The design of the FMUF connecting element ensures that the FMP massive profiles can be fastened to each other and to the substrate and makes it easy to fasten.
- The version of the FMUF connecting element with slot and grating to accommodate the toothed plate of the FMHB hammer-head push connector allows optimum adjustment of the supported profile for simple and safe installation.

Properties

- Material: Steel S235JR (material no. 1.0038) acc. to DIN EN 10025-2
- Galvanisation: Hot-dip galvanised, min. 55 µm, acc. to DIN EN ISO 1461
- Material hexagon nut: Steel resistance class 8

Installation FMUF

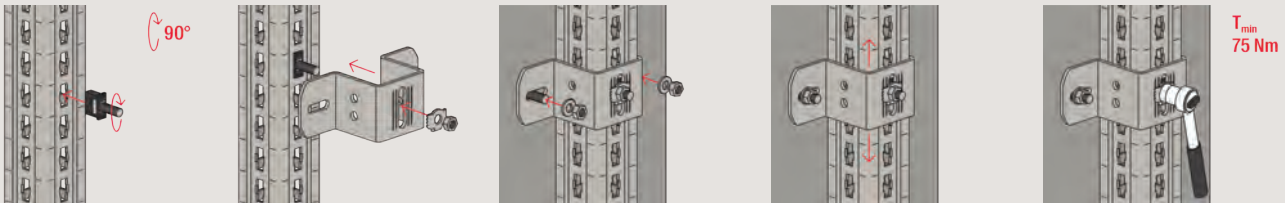

Technical data

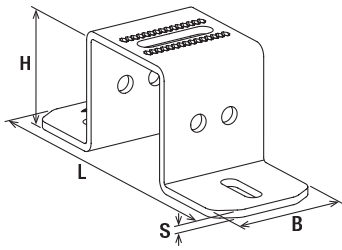

FMUF 90/120

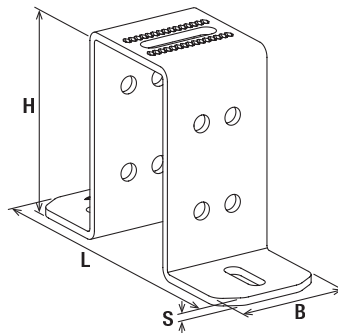

FMUF 160

Item	Item No.	Length L [mm]	Width B [mm]	Height H [mm]	Thickness S [mm]	Sales unit [pcs]
FMUF 90	547847	250	90	91	6	8
FMUF 120	547848	250	90	121	6	8
FMUF 160	547849	250	90	161	6	8

Fix point U-bolt FMFS UB

Element for fixing FMPS pipe shoes and FMFS fix point saddles

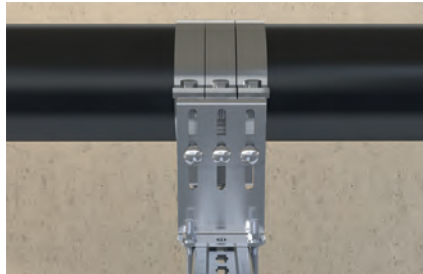

Fix-point construction with saddle

Applications

- Fastening the fix point and sliding elements onto the massive profile FMP

Advantages

- The FMFS UB fix point U-bolt is the precisely fitting element for quick and easy fastening of fix points or sliding elements to the massive profile FMP.
- The FMFS UB fix point U-bolt is available in 3 sizes and is the perfect fit for fastening for the 3 sizes of massive profiles FMP.

Properties

- Material: Steel S235JR (material no. 1.0038) acc. to DIN EN 10025-2
- Galvanisation: Hot-dip galvanised, min. 55 µm, acc. to DIN EN ISO 1461
- Material nut: steel grade 8.8

Installation FMFS UB

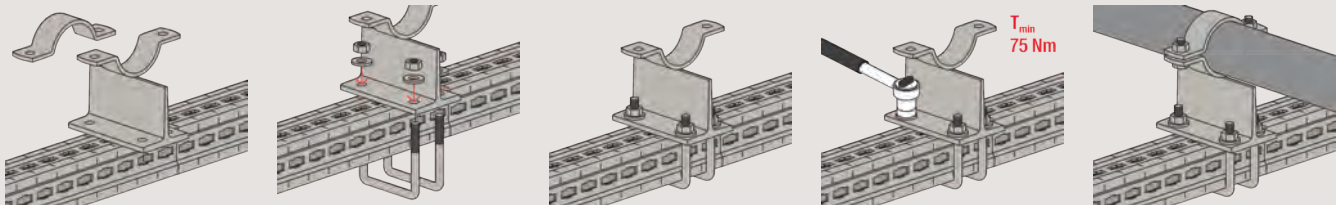

Technical data

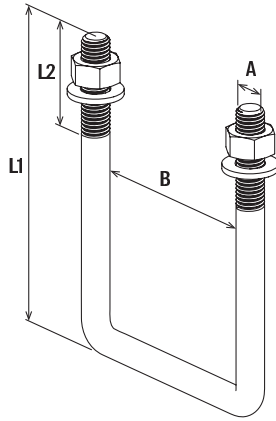

FMFS UB

Item	Item No.	Thread A	Length L ₁ [mm]	Length L ₂ [mm]	Width B [mm]	Sales unit [pcs]
FMFS UB 90	547850	M 12	130	45	91	50
FMFS UB 120	547851	M 12	160	45	91	40
FMFS UB 160	547852	M 12	200	45	91	30

3b

Pipe shoe sliding element FMFS

Element for fixing FMPS pipe shoes in case of thermal expansion

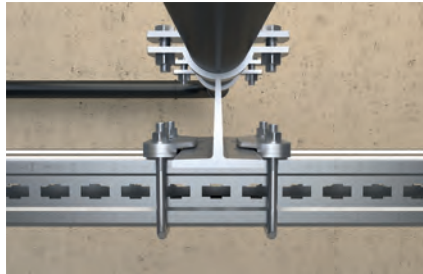

Slide bearing with pipe shoe

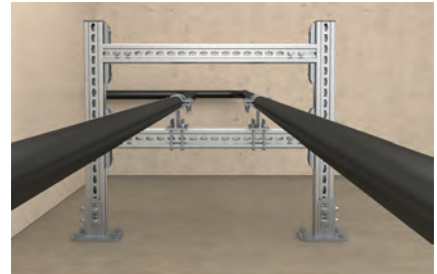

Frame construction

Applications

- Fixation of pipelines for thermal expansions

Advantages

- The sliding element FMFS can be attached to the pipe shoes FMPS to provide axial guidance and lifting for safe guidance in the moment of pipe expansion.
- The sliding element FMFS fits to all base plates of the pipe shoes FMPS due to the variably applicable distance plates and is easy to install.

Properties

- Material: Steel S235JR (material no. 1.0038) acc. to DIN EN 10025-2
- Galvanisation: Hot-dip galvanised, min. 55 µm, acc. to DIN EN ISO 1461

Installation FMFS

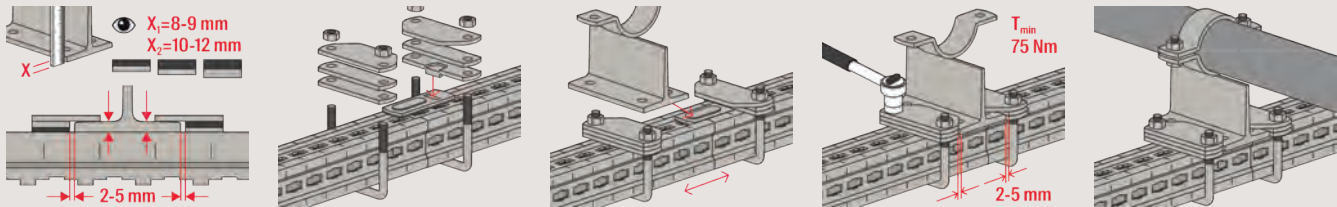

Technical data

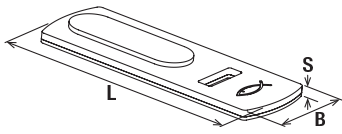

FMFS-SP

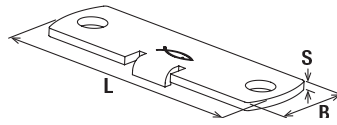

FMFS-SH

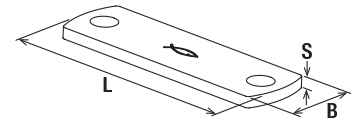

FMFS-DP

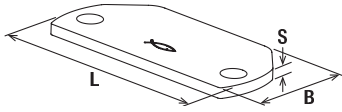

FMFS-LL

Item	Item No.	Length	Width	Thickness	Sales unit
		L [mm]	B [mm]	S [mm]	
FMFS SP	547853	113	40	4.5	10
FMFS SH	547854	130	35	4	10
FMFS DP4	547855	130	35	4	20
FMFS DP6	547856	130	35	6	20
FMFS LL	547857	130	60	6	20

Technical information

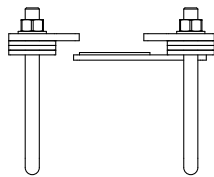

BG 1

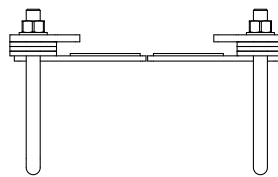

BG 2



BG 3

Item	Item No.	Thickness S [mm]	Required number of sliding elements - item per pipe shoe FMPS		
			BG 1 X 1 = 8 - 9 mm [pcs]	BG 2 X 1 = 8 - 9 mm [pcs]	BG 3 X 2 = 10 - 12 mm [pcs]
FMFS SP	547853	4,5	1	2	2
FMFS SH	547854	4	1	2	2
FMFS DP4	547855	4	5	4	-
FMFS DP6	547856	6	-	-	4
FMFS LL	547857	6	2	2	2

In addition, 2 FMFS UB fixed point brackets are required in each case - size matching the FMP profile.
The kind of assembly group is listed in the tables for the pipe shoes FMPS, see pages FMPS.

Fix-point-saddle FMFS S and M

Supporting element for fixing in case of thermal expansion

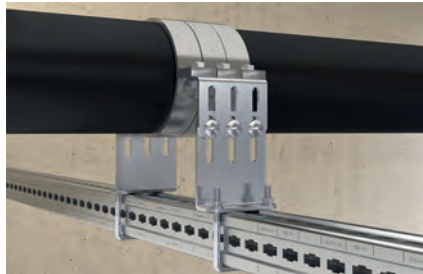

Fix-point construction to profile

Applications

- Fixation of pipelines for thermal expansions
- To use with the pipe clamp FMFSC as fix point. Up to 3 pipe clamps in row possible.

Advantages

- The modular design of the fixpoint saddle in 2 heights allows for optimum adaptation to the load level and pipe dimensions.
- The fixpoint saddle allows for good and simple height and inclination adjustment due to the slotted hole connections.

Properties

- Material: Steel S235JR (material no. 1.0038) acc. to DIN EN 10025-2
- Material hexagon nut: steel resistance class 8
- Galvanisation: Hot-dip galvanised, min. 55 µm, acc. to DIN EN ISO 1461
- Material screw: steel grade 8.8

Installation FMFS

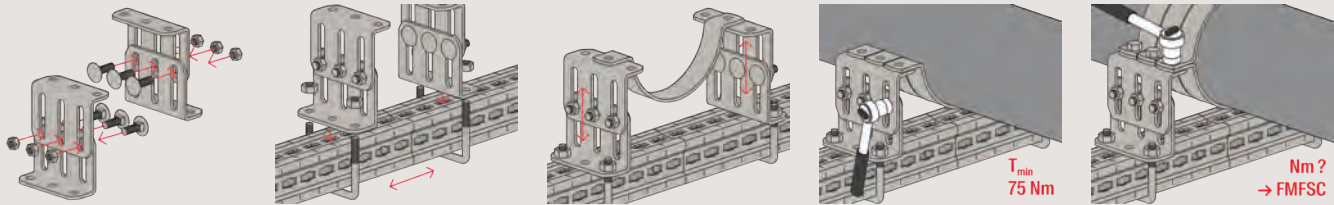

Technical data

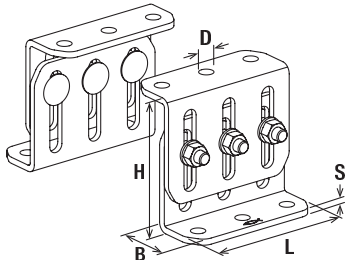

FMFS

Item	Item No.	Use with FMFSC pipe clamps	Length	Width	Total height	Hole-Ø	Thickness	Sales unit
			L [mm]	B [mm]	H [mm]	D [mm]	S [mm]	[pcs]
FMFS S	547860	≤ DN 80	140	54	115 - 175	14	6	2
FMFS M	547861	≥ DN100	140	54	175 - 240	17	6	2

3b

Pipe shoe FMPS

Prefabricated elements for fixing of pipes and massive profiles FMP



Frame construction

Applications

- Fixing of heavy duty pipelines up to DN600
- Can be used as sliding point
- Can be used as fix point

Advantages

- The designs of the pipe shoes with one or two pipe clamps in standard and solid version allows for fastening of heavy duty pipes.
- Due to the additional perforation, the pipe shoes FMPS can be used as fix points to attach with the FMFS UB fix point U-bolt to the FMP massive profile.
- The pipe shoes FMPS can be used as sliding elements by attaching the pipe shoes-sliding bearing to the FMP massive profile.

Properties

- Material: Steel S235JR (material no. 1.0038) acc. to DIN EN 10025-2
- Galvanisation: Hot-dip galvanised, min. 55 µm, acc. to DIN EN ISO 1461
- Material screw: steel grade 8.8
- Material hexagon nut: steel resistance class 8

Installation FMPS

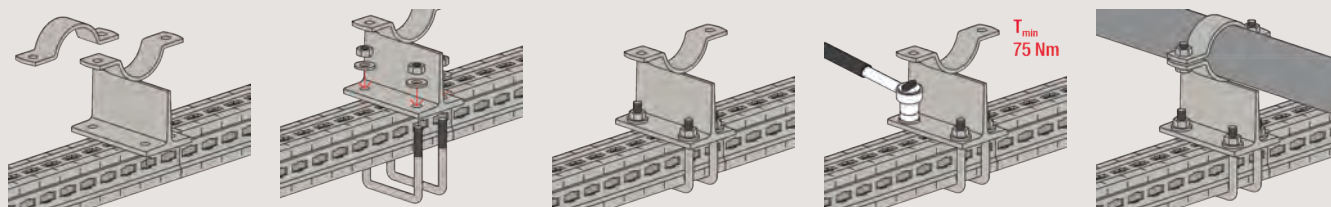

Technical data

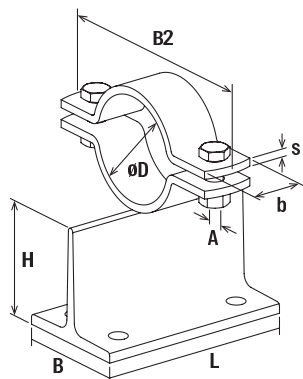

FMPS 1/1

Item	Item No.	Size [inch]	Clamping range		Length L [mm]	Width B [mm]	Height H [mm]	Width B [mm]	Width x thickness clamp band b x s [mm]	Thread A	Assembly group BG	Sales unit [pcs]
			D [mm]	L [mm]								
FMPS 25 1/1-80	547862	1")	34	150	90	87.5	102	30 x 5	M 10	1	1	
FMPS 40 1/1-80	547863	1 1/2")	49	150	90	87.5	118	30 x 5	M 10	1	1	
FMPS 50 1/1-80	547864	2")	61	150	90	87.5	144	40 x 6	M 12	1	1	
FMPS 65 1/1-80	547865	2 1/2")	77	150	90	87.5	158	40 x 6	M 12	1	1	
FMPS 80 1/1-80	547866	3")	89	150	90	87.5	172	40 x 6	M 12	1	1	
FMPS 25 1/1-150	548410	1")	34	150	150	150	102	30 x 5	M 10	2	1	
FMPS 40 1/1-150	547867	1 1/2")	49	150	150	150	118	30 x 5	M 10	2	1	
FMPS 50 1/1-150	547868	2")	61	150	150	150	144	40 x 6	M 12	2	1	
FMPS 65 1/1-150	547869	2 1/2")	77	150	150	150	158	40 x 6	M 12	2	1	
FMPS 80 1/1-150	547870	3")	89	150	150	150	172	40 x 6	M 12	2	1	
FMPS 100 1/1-150	547871	4")	115	150	150	150	220	50 x 8	M 16	2	1	
FMPS 125 1/1-150	547872	5")	140	150	150	150	252	50 x 8	M 16	2	1	
FMPS 150 1/1-150	547873	6")	169	150	150	150	280	50 x 8	M 16	2	1	
FMPS 200 1/1-150	547874	8")	220	150	150	150	332	50 x 8	M 16	2	1	

1) Delivery on request.

3b

Technical data

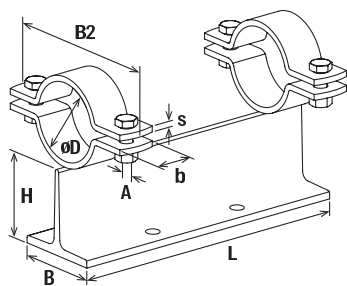

FMPS 1/2

Item	Item No.	Size [inch]	Clamping range		Length L [mm]	Width B [mm]	Height H [mm]	Width B [mm]	Width x thickness clamp band b x s [mm]	Thread A	Assembly group BG	Sales unit [pcs]
			D [mm]	L [mm]								
FMPS 25 1/2-80	547875	1")	34	300	90	87.5	102	30 x 5	M 10	1	1	
FMPS 40 1/2-80	547877	1 1/2")	49	300	90	87.5	118	30 x 5	M 10	1	1	
FMPS 50 1/2-80	547879	2")	61	300	90	87.5	144	40 x 6	M 12	1	1	
FMPS 65 1/2-80	547881	2 1/2")	77	300	90	87.5	158	40 x 6	M 12	1	1	
FMPS 80 1/2-80	547883	3")	89	300	90	87.5	172	40 x 6	M 12	1	1	

1) Delivery on request.

Technical data

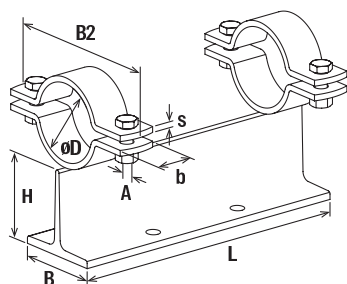

FMPS 1/2

Item	Item No.	Size	Clamping range	Length	Width	Height	Width	Width x thickness clamp band	Thread	Assembly group	Sales unit
		[inch]	D [mm]	L [mm]	B [mm]	H [mm]	B [mm]	b x s [mm]	A	BG	[pcs]
FMPS 100 1/2-110	547885	4"	115	300	125	125	220	50 x 8	M 16	1	1
FMPS 125 1/2-110	547887	5"	140	300	125	125	252	50 x 8	M 16	1	1
FMPS 150 1/2-110	547889	6"	169	300	125	125	280	50 x 8	M 16	1	1
FMPS 200 1/2-110	547891	8"	220	300	125	125	332	50 x 8	M 16	1	1
FMPS 25 1/2-150	547876	1)"	34	300	150	150	102	30 x 5	M 10	2	1
FMPS 40 1/2-150	547878	1) 1 1/2"	49	300	150	150	118	30 x 5	M 10	2	1
FMPS 50 1/2-150	547880	1) 2"	61	300	150	150	144	40 x 6	M 12	2	1
FMPS 65 1/2-150	547882	1) 2 1/2"	77	300	150	150	158	40 x 6	M 12	2	1
FMPS 80 1/2-150	547884	1) 3"	89	300	150	150	172	40 x 6	M 12	2	1
FMPS 100 1/2-150	547886	1) 4"	115	300	150	150	220	50 x 8	M 16	2	1
FMPS 125 1/2-150	547888	1) 5"	140	300	150	150	252	50 x 8	M 16	2	1
FMPS 150 1/2-150	547890	1) 6"	169	300	150	150	280	50 x 8	M 16	2	1
FMPS 200 1/2-150	547892	1) 8"	220	300	150	150	332	50 x 8	M 16	2	1

1) Delivery on request.

Technical data

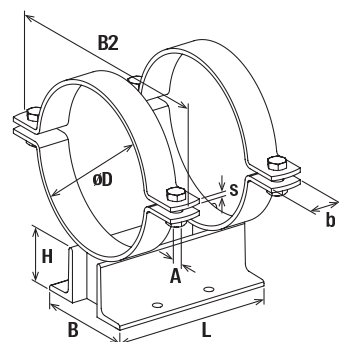

FMPS 2/2

Item	Item No.	Size	Clamping range	Length	Width	Height	Width	Width x thickness clamp band	Thread	Assembly group	Sales unit
		[inch]	D [mm]	L [mm]	B [mm]	H [mm]	B [mm]	b x s [mm]	A	BG	[pcs]
FMPS 250 2/2-110	547893	10"	273	300	200	100	396	50 x 8	M 16	3	1
FMPS 300 2/2-110	547894	12"	324	300	200	100	458	60 x 8	M 20	3	1
FMPS 350 2/2-110	547895	14"	356	300	200	100	504	60 x 8	M 20	3	1
FMPS 400 2/2-110	547896	16"	407	300	200	100	582	70 x 10	M 24	3	1
FMPS 500 2/2-110	547897	20"	508	300	250	100	672	70 x 10	M 24	3	1
FMPS 600 2/2-110	547898	24"	610	300	250	100	814	90 x 15	M 30	3	1
FMPS 250 2/2-150	547899	1) 10"	273	300	200	140	396	50 x 8	M 16	3	1

1) Delivery on request.

Technical data

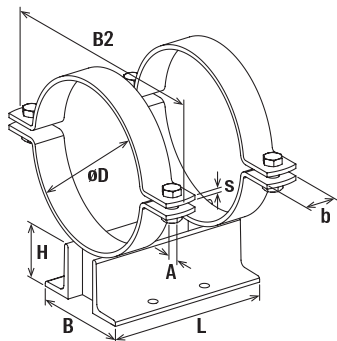

FMPS 2/2

Item	Item No.	Size	Clamping range	Length	Width	Height	Width	Width x thickness clamp band	Thread	Assembly group	Sales unit
		[inch]	D [mm]	L [mm]	B [mm]	H [mm]	B [mm]	b x s [mm]	A	BG	[pcs]
FMPS 300 2/2-150	547900	12"	324	300	200	140	458	60 x 8	M 20	3	1
FMPS 350 2/2-150	547901	14"	356	300	200	140	504	60 x 8	M 20	3	1
FMPS 400 2/2-150	547902	16"	407	300	200	140	582	70 x 10	M 24	3	1
FMPS 500 2/2-150	547903	20"	508	300	250	140	672	70 x 10	M 24	3	1
FMPS 600 2/2-150	547904	24"	610	300	250	140	814	90 x 15	M 30	3	1

1) Delivery on request.

3b

Massive pipe clamp FMFSC

Element for stable fixing of pipes and massive profiles FMP

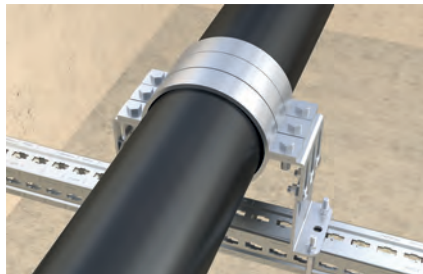

Fix-point clamp construction

Applications

- Fixing of heavy duty pipelines up to DN250
- Can be used as a fixed point in combination with the FMFS saddle

Advantages

- The fischer solid pipe clamps FMFSC without rubber insert for fastening pipelines up to DN 250 can reliably fix heavy duty pipelines and can be used in many applications.

Properties

- Material: Steel S235JR (material no. 1.0038) acc. to DIN EN 10025-2
- Galvanisation: Hot-dip galvanised, min. 55 µm, acc. to DIN EN ISO 1461
- Material screw: steel grade 8.8
- Material hexagon nut: steel resistance class 8

Installation FMFSC

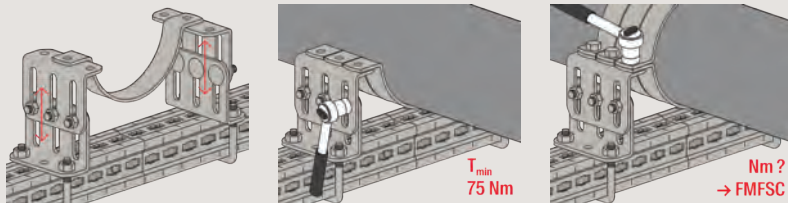

Technical data

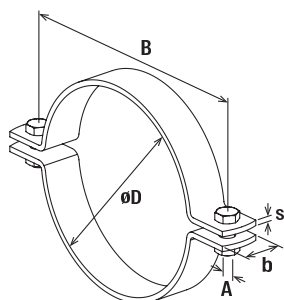

FMFSC

Item	Item No.	Size [inch]	Clamping range D [mm]	Width B [mm]	Width x thick- ness clamp band b x s [mm]	Thread A	Tightening torque T _{inst} [Nm]	Sales unit [pcs]
FMFSC 25	547905	1"	34	72	30 x 5	M 10	30	1
FMFSC 32	547906	1 1/4"	43	82	30 x 5	M 10	30	1
FMFSC 40	547907	1 1/2"	49	88	30 x 5	M 10	30	1
FMFSC 50	547909	2"	61	108	40 x 6	M 12	50	1
FMFSC 65	547910	2 1/2"	77	122	40 x 6	M 12	50	1
FMFSC 80	547911	3"	89	136	40 x 6	M 12	50	1
FMFSC 100	547913	4"	115	172	50 x 8	M 16	100	1
FMFSC 125	547915	5"	140	204	50 x 8	M 16	100	1
FMFSC 150	547918	6"	169	232	50 x 8	M 16	100	1
FMFSC 200	547919	8"	220	284	50 x 8	M 16	100	1
FMFSC 250/50	547921	10"	273	348	50 x 8	M 16	100	1

3b

Massive U-bolt FMPSU

Simple element for fixing of pipes and massive profile FMP



Profil traverse to steel structure

Applications

- Fixing of heavy duty pipelines up to DN250

Advantages

- The FMPSU massive U-bolt for fixing heavy duty pipelines directly onto the FMP massive profile is the simplest type of connection for heavy duty pipelines.

Properties

- Material: Steel S235JR (material no. 1.0038) acc. to DIN EN 10025-2
- Galvanisation: Hot-dip galvanised, min. 55 µm, acc. to DIN EN ISO 1461
- Material screw: steel grade 8.8
- Material hexagon nut: steel resistance class 8

Installation FMPSU

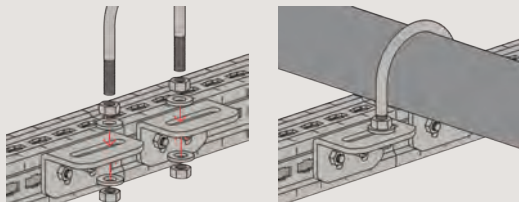

See also

Connecting element FMCE-L



Technical data

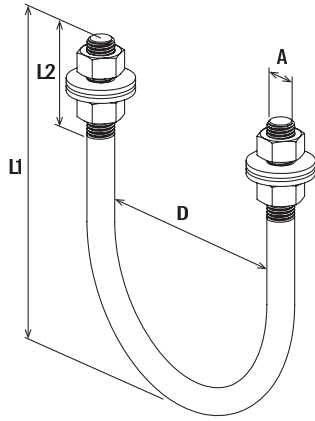

FMPSU

Item	Item No.	Size [inch]	Clamping range D [mm]	Length L ₁ [mm]	Length L ₂ [mm]	Thread A	Sales unit [pcs]
FMPSU 25	547929	1"	38	70	40	M 10	50
FMPSU 32	547930	1 1/4"	46	76	50	M 10	50
FMPSU 40	547931	1 1/2"	52	86	50	M 10	50
FMPSU 50	547933	2"	64	109	50	M 12	50
FMPSU 65	547934	2 1/2"	82	125	50	M 12	50
FMPSU 80	547935	3"	94	138	50	M 12	50
FMPSU 100	547937	4"	120	171	60	M 16	25
FMPSU 125	547939	5"	148	191	60	M 16	20
FMPSU 150	547941	6"	176	217	60	M 16	15
FMPSU 200	547942	8"	228	283	70	M 20	8
FMPSU 250	547943	10"	282	334	70	M 20	8

3b



4

4

Installation system stainless steel

Pipe clamp FRS A2/A4	328	
FUS Channel A2/A4	329	
Cantilever arm FCA A4	329	
Channel connector FDCC A4	330	
Saddle flange SF L A4	332	
Mounting bracket FAF A4	333	
Variable bracket VB A2	334	
Channel washer HK 41 A4	335	
Beam clamp TKR A4	335	
Stud screw STS A2/A4	336	
Clix channel nut FCN Clix A4	336	
Threaded rod G A2/A4	337	
Threaded stud GS A4	337	
Hexagonal connector VM A4	338	
Washer U A4	338	
Hexagonal nut MU A4	339	
Hexagonal screw SKS A4	339	

Pipe clamp FRS A2/A4

Technical data

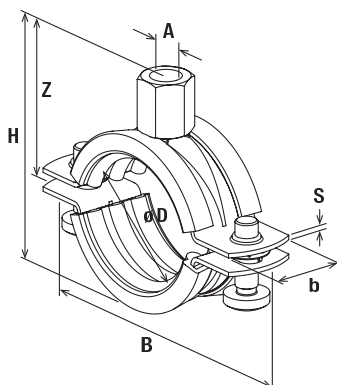

Properties

- Material: stainless steel A2: material-no 1.4301, acc. DIN EN 10088-1
- Material: stainless steel A4: material-no 1.4401, acc. DIN EN 10088-1
- Material sound insulation insert: EPDM; chlorine-free; silicone-free
- Temperature range: -40 °C to +100 °C
- Hardness: 55 ± 5° Shore A
- Fire behaviour: DIN 4102: Class B2

FRS A2

FRS M8/M10

Item	Item No.	Thread	Size	Clamping range	Width	Height	Width x thickness clamp band	Height Z	Locking screw	Max. recom. static load (centr. tension)	Sales unit
		A	[inch]	D [mm]	B [mm]	H [mm]	b x s [mm]	Z [mm]	N _{recom.} [kN]	[pcs]	
FRS 3/8" A2	064290	M 8	3/8"	15 - 19	62	40	20 x 1,2	23	M 6	1.00	100
FRS 1/2" A2	064536	M 8	1/2"	20 - 24	68	45	20 x 1,2	26	M 6	1.00	100
FRS 3/4" A2	064639	M 8	3/4"	25 - 30	75	52	20 x 1,2	29	M 6	1.00	100
FRS 1" A2	064646	M 8	1"	31 - 38	80	60	20 x 1,2	32	M 6	1.00	100
FRS 1 1/4" A2	064669	M 8	1 1/4"	40 - 46	90	67	20 x 1,2	37	M 6	1.00	50
FRS 1 1/2" A2	064673	M 8	1 1/2"	48 - 54	97	75	20 x 1,2	41	M 6	1.00	50
FRS 54 - 58 A2	064674	M 8	—	54 - 59	104	80	20 x 1,2	44	M 6	1.00	50
FRS 2" A2	064675	M 8	2"	60 - 64	110	85	20 x 1,2	46	M 6	1.00	50
FRS 67 - 71 A2	064688	M 8	—	67 - 71	119	92	20 x 1,2	49	M 6	1.00	25
FRS 2 1/2" A2	064689	M 10	2 1/2"	72 - 78	130	99	25 x 1,5	53	M 6	1.30	25
FRS 81 - 86 A2	064693	M 10	—	81 - 86	132	107	25 x 1,5	58	M 6	1.30	25
FRS 3" A2	064694	M 10	3"	87 - 92	144	113	25 x 1,5	60	M 6	1.30	25
FRS 95 - 103 A2	064695	M 10	—	95 - 103	156	124	25 x 1,5	66	M 6	1.30	25
FRS 4" A2	064697	M 10	4"	102 - 116	172	138	25 x 2,0	73	M 6	2.0	20
FRS 121 - 127 A2	064709	M 10	—	121 - 127	192	149	25 x 2,0	79	M 8	2.0	10
FRS 133 - 141 A2	064713	M 10	5"	133 - 141	198	163	25 x 2,0	86	M 8	2.0	10
FRS 159 - 168 A2	064714	M 10	6"	159 - 169	218	191	25 x 2,0	100	M 8	2.0	8
FRS 3/8" A4	064864	M 8	3/8"	15 - 19	62	40	20 x 1,2	23	M 6	1.00	100
FRS 1/2" A4	064865	M 8	1/2"	20 - 24	68	45	20 x 1,2	26	M 6	1.00	100
FRS 3/4" A4	064866	M 8	3/4"	25 - 30	75	52	20 x 1,2	29	M 6	1.00	100
FRS 1" A4	064868	M 8	1"	31 - 38	80	60	20 x 1,2	32	M 6	1.00	100
FRS 1 1/4" A4	064869	M 8	1 1/4"	40 - 46	90	67	20 x 1,2	37	M 6	1.00	50
FRS 1 1/2" A4	064870	M 8	1 1/2"	48 - 54	97	75	20 x 1,2	41	M 6	1.00	50
FRS 54 - 58 A4	064873	M 8	—	54 - 59	104	80	20 x 1,2	44	M 6	1.00	50
FRS 2" A4	064874	M 8	2"	60 - 64	110	85	20 x 1,2	46	M 6	1.00	50
FRS 67 - 71 A4	064875	M 8	—	67 - 71	119	92	25 x 1,2	49	M 6	1.00	25
FRS 2 1/2" A4	064879	M 10	2 1/2"	72 - 78	130	99	25 x 1,5	53	M 6	1.30	25
FRS 81 - 86 A4	064892	M 10	—	81 - 86	132	107	25 x 1,5	58	M 6	1.30	25
FRS 3" A4	064893	M 10	3"	87 - 92	144	113	25 x 1,5	60	M 6	1.30	25
FRS 95 - 103 A4	064894	M 10	—	95 - 103	156	124	25 x 1,5	66	M 6	1.30	25
FRS 4" A4	064898	M 10	4"	102 - 116	172	138	25 x 2,0	73	M 6	2.0	20
FRS 121 - 127 A4	064899	M 10	—	121 - 127	192	149	25 x 2,0	79	M 8	2.0	10
FRS 133 - 141 A4	064901	M 10	5"	133 - 141	198	163	25 x 2,0	86	M 8	2.0	10
FRS 159 - 168 A4	064903	M 10	6"	159 - 168	218	191	25 x 2,0	100	M 8	2.0	8

FUS Channel A2/A4

Technical data

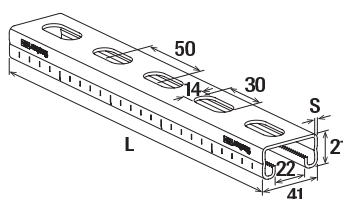

FUS 21 A2/A4

FUS 21

Properties

- Material: stainless steel A2: material-no 1.4301, acc. DIN EN 10088-1
- Material: stainless steel A4: material-no 1.4401, acc. DIN EN 10088-1

Item	Item No.	Fire test report	Length L [mm]	Profile thickness [mm]	Sales unit [pcs]
FUS 21/2,0 A2 - 2 m	504466	—	2000	2	1
FUS 21/2,0 A2 - 6 m	542735 ¹⁾	—	6000	2	1
FUS 41/2,0 A2 - 2 m	504468	—	2000	2	1
FUS 41/2,0 A2 - 6 m	542736 ¹⁾	—	6000	2	1
FUS 41/2,5 A2 - 2 m	504470	X	2000	2,5	1
FUS 41/2,5 A2 - 6 m	542737 ¹⁾	X	6000	2,5	1
FUS 21/2,0 A4 - 2 m	504472	—	2000	2	1
FUS 21/2,0 A4 - 6 m	542738 ¹⁾	—	6000	2	1
FUS 41/2,0 A4 - 2 m	504474	—	2000	2	1
FUS 41/2,0 A4 - 6 m	542739 ¹⁾	—	6000	2	1
FUS 41/2,5 A4 - 2 m	504475	X	2000	2,5	1
FUS 41/2,5 A4 - 6 m	542740 ¹⁾	X	6000	2,5	1

¹⁾ Delivery time on request.

For loads and weight of channels and cantilever arms see page 98

4

Cantilever arm FCA A4

Technical data

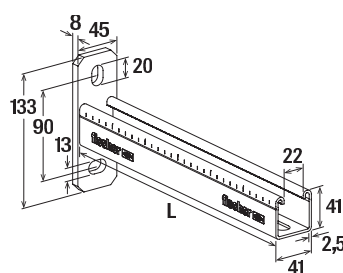

FCA A4

FCA

Properties

- Material: stainless steel A4: material-no 1.4401, acc. DIN EN 10088-1

Item	Item No.	Fire test report	Length L [mm]	Sales unit [pcs]
FCA 41 A4 - 300	505487	X	300	1
FCA 41 A4 - 450	505488	X	450	1
FCA 41 A4 - 600	505489	X	600	1

For loads and weight of channels and cantilever arms see page 98

Channel connector FDCC A4

FDCC A4 channel connector - For easy preparation of FUS double channels

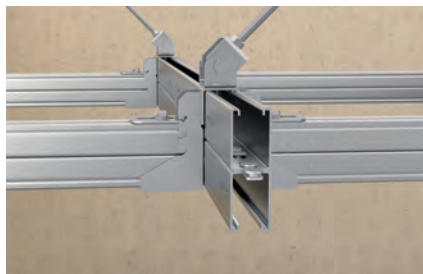
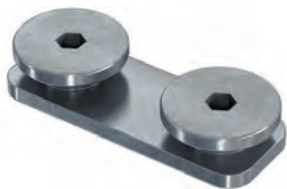

FUS double channel with channel connector

Applications

- Easy construction of double channels made from the FUS channel assortment.
- Suitable for FUS channels FUS 41 and FUS 62 with thickness 2,0 and 2,5 mm.
- The connection of two single channels is made with the channel connector inside the channel slots.
- Each double channel has to be equipped with an FDCC at both ends and additional FDCCs in the given installation distance as per load chart.
- For indoor and outdoor applications and in environments with high stress to components due to corrosion

Advantages/benefits

- Easy connection of single channels backside to backside to build double channels
- Simple solution to create individual double channels on job site
- The stainless steel surface offers good corrosion protection against environmental influences like moisture, water, salt water and other corrosive agents

Properties

- Material base plate: A4 stainless steel (material no. 1.4401)
- Material screw: A4 stainless steel (material no. 1.4401)

4

Technical data

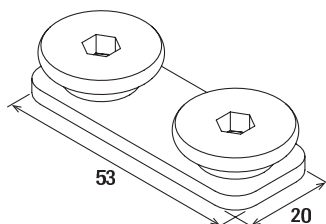

FDCC

Item	Item No.	Thread A	Drive	Tightening torque T_{inst} [Nm]	Sales unit [pcs]
FDCC A4	557376	M 10	Hexagon socket 5 mm	25	100

FUS 41D/2,0 - 2,5

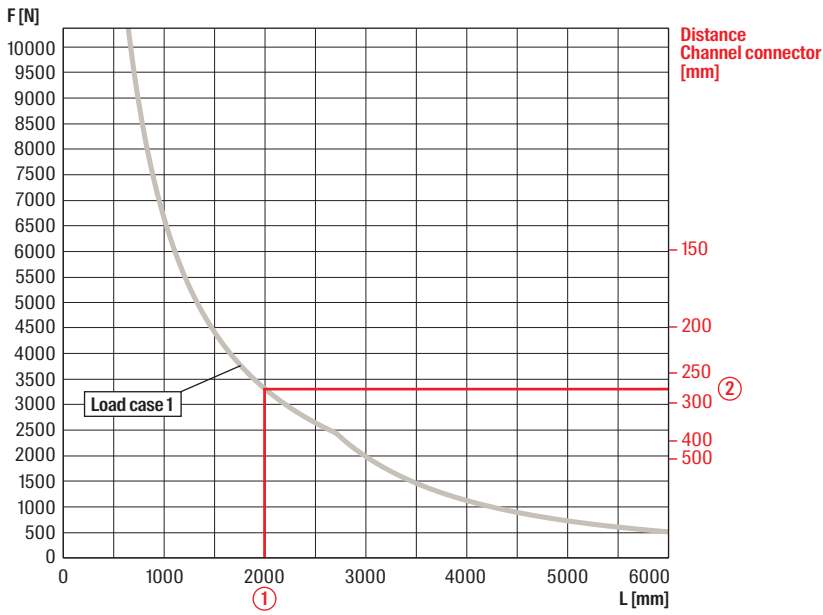

- ① Length of channel, i.e. 2000 mm for loadcase 1 (single load centric)
- ② Distance of channel connector (for intermediate values use the lower value, i.e. 250 mm)

FUS 62D/2,5

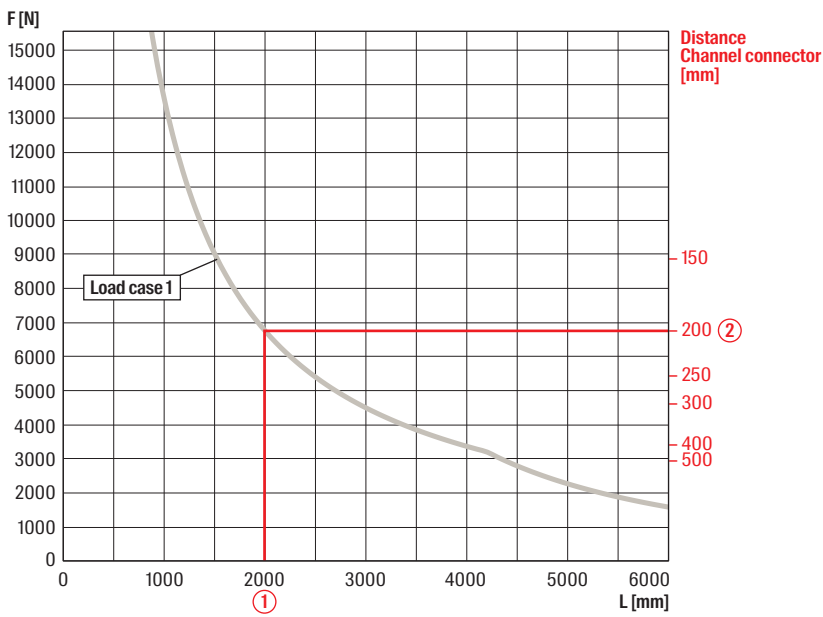

- ① Length of channel, i.e. 2000 mm for loadcase 1 (single load centric)
- ② Distance of channel connector (for intermediate values use the lower value, i.e. 250 mm)

Load case 1

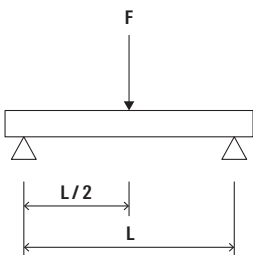

Saddle flange SF L A4

Technical data

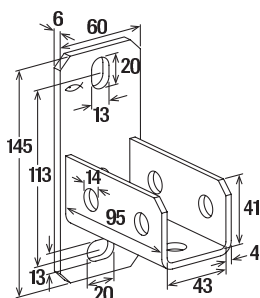

Properties

- Material: stainless steel A4: material-no 1.4401, acc. DIN EN 10088-1

SFL A4

SFL A4

Item	Item No.	Fire test report	For profile	Sales unit [pcs]
SFL 41 A4	504522	X	FUS 21 + FUS 41	10

Mounting bracket FAF A4

Technical data



FAF 2 A4

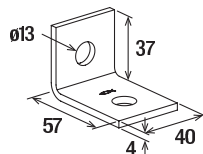

FAF 2

Properties

- Material: stainless steel A4: material-no 1.4401, acc. DIN EN 10088-1



FAF 4 A4

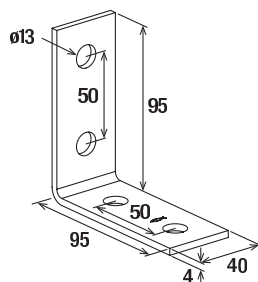

FAF 4



FAF 4/135° A4

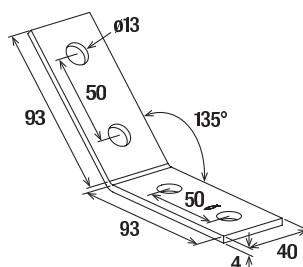

FAF 4/135°

4

Item	Item No.	Sales unit	
		[pcs]	
FAF 2 A4	547512	25	
FAF 4 A4	547513	25	
FAF 4/135° A4	547514	25	

Variable bracket VB A2

Construction element – Variable bracket VB A2



Massive bracing of cantilever arm

Applications

- Variable bracket for FUS channel profiles to built up supporting structures
- Bracket for installation with FUS channels from 0° to 180°
- For indoor and outdoor applications and in environments with high stress to components due to corrosion

Advantages/Benefits

- The design of the variable bracket VB enables the fixation of mounting channels at an angle of 0° to 180°.
- Due to the perforations on all sides of the VB, rails can be mounted with the rail opening facing downwards or laterally.
- The punched holes in the base plate allow the direct fixing onto a wall, ceiling or onto a mounting channel.
- The surface coating creates a high corrosion protection against environmental influences like humidity, water, saltwater or other corrosive substances.

Properties

- Material: stainless steel A2: material-no 1.4301, acc. DIN EN 10088-1

Technical data

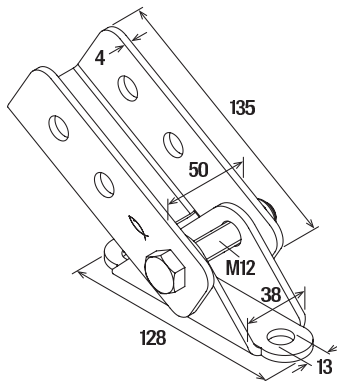

VB

Item	Item No.	Sales unit
		[pcs]
VB A2	545651	5

Loads

See Channel nut FCN Clix P

Beam clamp TKR A4

Technical data

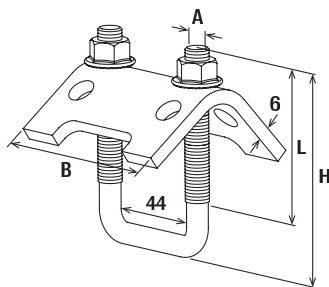

Properties

- Material: stainless steel A4: material-no 1.4401, acc. DIN EN 10088-1

TKR

TKR

Item	Item No.	For profile	Sales unit
TKR 21 - 42 A4	559751	FUS 21 + FUS 41	[pcs] 10

Channel washer HK 41 A4

Technical data

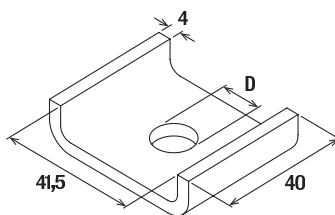
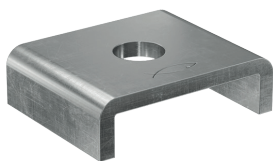

Properties

- Material: stainless steel A4: material-no 1.4401, acc. DIN EN 10088-1

HK 41 12,5 - A4

HK 41

Item	Item No.	Fire test report	For profile	Hole-Ø D [mm]	Sales unit
HK 41 12,5 - A4	559750	X	all FUS channels	12.5	[pcs] 25

4

Clix channel nut FCN Clix A4

Technical data



FCN Clix P

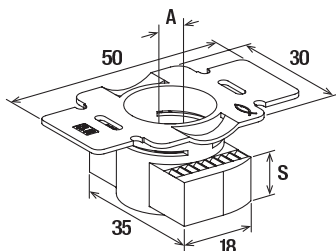

FCN Clix P

Properties

- Material: stainless steel A4: material-no 1.4401, acc. DIN EN 10088-1
- Plastic: Nylon PA 6

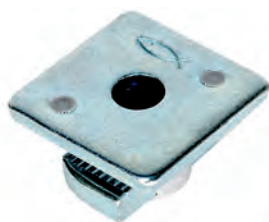

FCN Clix M

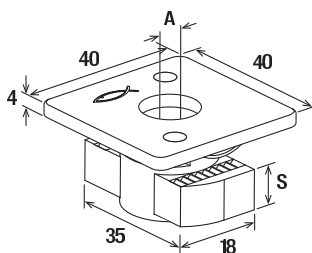

FCN Clix M

4

Item	Item No.	Thread A	Thickness S [mm]	Sales unit [pcs]
FCN Clix P 8 A4	559754	M 8	6	25
FCN Clix P 10 A4	559755	M 10	8	25
FCN Clix P 12 A4	559756	M 12	9.5	25
FCN Clix M 8 A4	559752	M 8	6	25
FCN Clix M 10 A4	559753	M 10	8	25

Stud screw STS A2/A4

Technical data

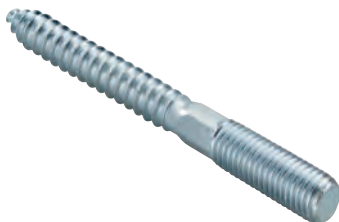

STS

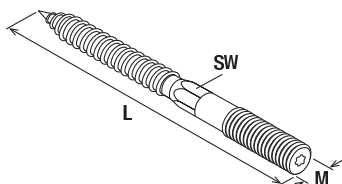

STS

Properties

- Material: stainless steel A2: material-no 1.4301, acc. DIN EN 10088-1
- Material: stainless steel A4: material-no 1.4401, acc. DIN EN 10088-1

Item	Item No.	Thread A	Length L [mm]	Sales unit [pcs]
STS 8 x 80 A2	065132	M 8	80	100
STS 8 x 100 A2	077643	M 8	100	100
STS 10 x 100 A2	065153	M 10	100	100
STS 8 x 100 A4	077715	M 8	100	100
STS 10 x 100 A4	077716	M 10	100	100

Threaded rod G A2/A4

Technical data



G

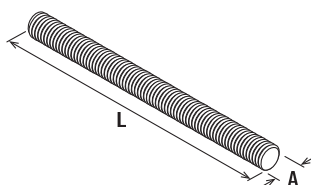

G

Properties

- Material: stainless steel A2: material-no 1.4301, acc. DIN EN 10088-1
- Material: stainless steel A4: material-no 1.4401, acc. DIN EN 10088-1
- Property class: min. 70 (A2 / A4)

Item	Item No.	Length L [mm]	Thread A	Sales unit [pcs]
G 8 A2	077644	1000	M 8	5
G 10 A2	065173	1000	M 10	5
G 8 A4	077645	1000	M 8	5
G 10 A4	065174	1000	M 10	5

Threaded stud GS A4

4

Technical data



GS

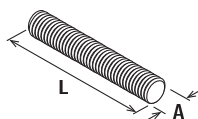

GS

Properties

- Material: stainless steel A4: material-no 1.4401, acc. DIN EN 10088-1
- Property class: min. 70 (A2 / A4)

Item	Item No.	Length L [mm]	Thread A	Sales unit [pcs]
GS 8/40 A4	559698	40	M 8	50
GS 8/60 A4	559699	60	M 8	50
GS 10/40 A4	559700	40	M 10	50
GS 10/60 A4	559701	60	M 10	50

Hexagonal connector VM A4

Technical data

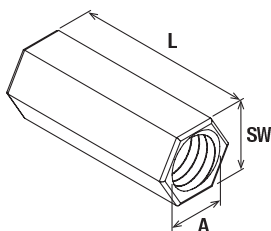

VM

VM

Properties

- Material: stainless steel A4: material-no 1.4401, acc. DIN EN 10088-1

Item	Item No.	Length L [mm]	Thread A	Width across nut SW [mm]	Sales unit [pcs]
VM M8 A4	559706	30	M 8	11	50
VM M10 A4	559707	30	M 10	13	50

Washer U A4

4

Technical data



U

Properties

- Material: stainless steel A4: material-no 1.4401, alternative 1.4571 acc. DIN EN 10028-7

Item	Item No.	Thickness S [mm]	External-Ø d [mm]	Hole-Ø D [mm]	Sales unit [pcs]
U 8 x 28 A4	505542	2	28	8.4	100
U 8 x 40 A4	505543	3	40	8.4	100
U 10 x 28 A4	505544	2	30	10.5	100
U 10 x 40 A4	505545	3	40	10.5	100
U 12 x 24 A4	505546	2	24	12.5	100

Hexagonal nut MU A4

Technical data

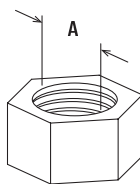

Properties

- Material: stainless steel A4, acc. to DIN EN ISO 3506-2
- Property class: min. 50, acc. to DIN EN ISO 3506-2

MU

MU

Item	Item No.	Thread A	Width across nut SW [mm]	Sales unit [pcs]
MU M8 A4	559702	M 8	13	50
MU M10 A4	559703	M 10	17	50

Hexagonal screw SKS A4

Technical data

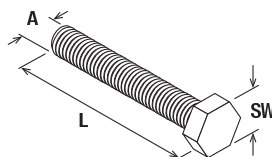

Properties

- Material: stainless steel A4, material-no. 1.4401, acc. to DIN EN ISO 3506-1
- Property class: min. 70, acc. to DIN EN ISO 3506-1)

SKS

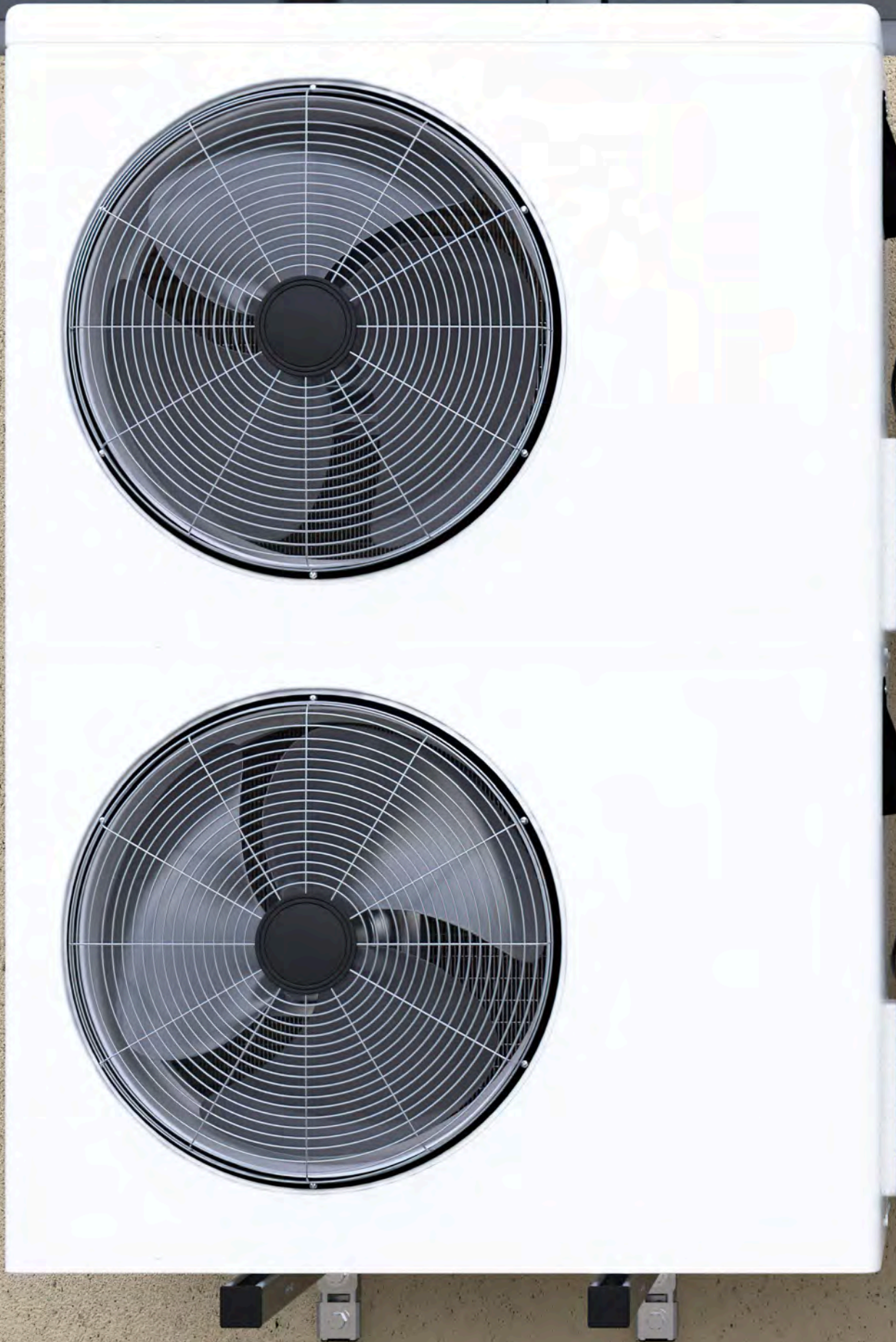

Item	Item No.	Thread A	Length L [mm]	Width across nut SW [mm]	Sales unit [pcs]
SKS M10 x 30 A4	559704	M 10	30	17	50
SKS M12 x 30 A4	559705	M 12	30	19	50

4



5

Air conditioner fixings

Air conditioner fixing MCE	342	
Air conditioner fixing KSU	344	

Air conditioner fixing MCE

The complete kit for air conditioner fixing on walls



Airconditioner on the outer wall

Applications

- Universal fixing for air conditioners
- MCE Klima Klik - air conditioner fixing onto walls with max. fixing distance of 760 mm on the horizontal channel
- Please consider: load bearing capacity of the wall and the quality of the substrate

Advantages/benefits

- The complete kit including anti vibration dumper, SX plug and screws offers an optimised installation security.
- The brackets with quick snap (Klik) simplify and shorten the installation.
- The horizontal channel of the MCE Klima Klik allows a flexible adjustment of the brackets and simplifies the installation additionally.
- The MCE Klima Klik horizontal channel with snap-on bubble level enables the adjustment without additional tools.

Properties

- Material: steel
- Coating: powder coating
- Colour: RAL 9002

Installation MCE LP

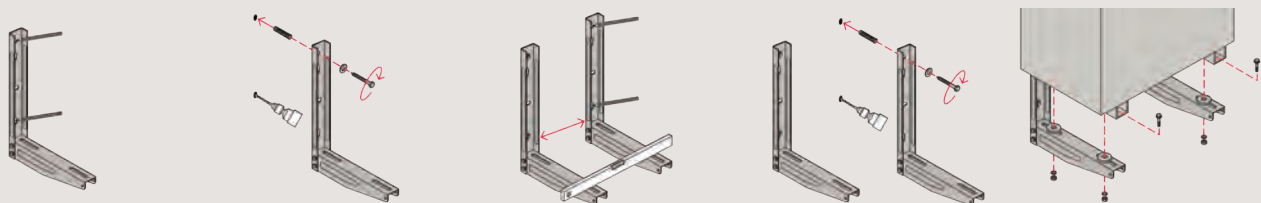

Installation MCE PT

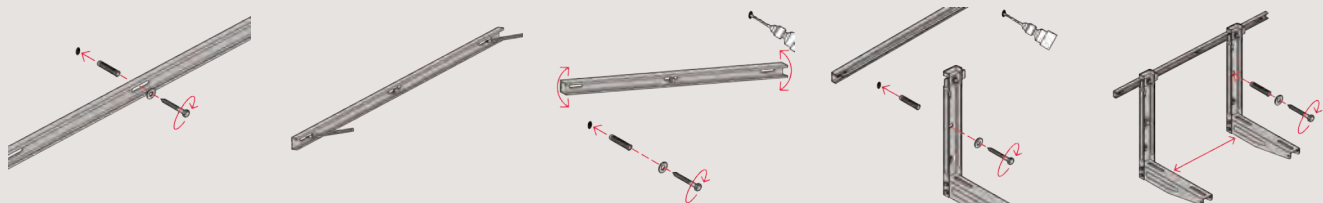

Technical data

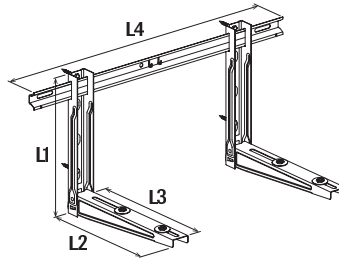
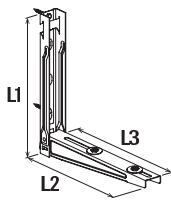

KLIMA EASY KLIK

KLIMA KLIK

Item	Item No.	Length	Length	Length	Length	Max. recom- mended static load load case 1	Max. recom- mended static load load case 2	Sales unit [pcs]
		L ₁ [mm]	L ₂ [mm]	L ₃ [mm]	L ₄ [mm]	F _{rec} [kN]	F _{rec} [kN]	
KLIMA EASY KLIK	521760 ¹⁾	400	420	380	—	1.0	1.0	1
KLIMA KLIK 420	521761 ¹⁾	400	420	380	780	1.0	1.0	1

1) The loads are valid for the use in pairs (two consoles).

Load case 1

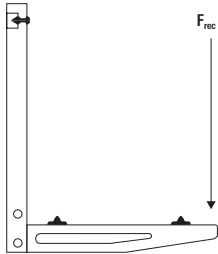

Load case 2

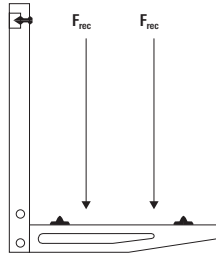

Air conditioner fixing KSU

The complete kit for fixing of Air conditioners, pumps or ventilators on walls

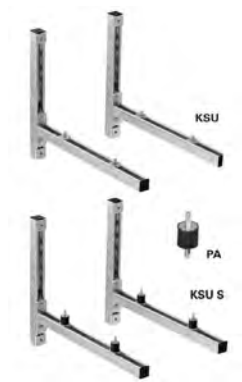

Air conditioning units

Applications

- Secure attachment of air conditioners, pumps and fans to walls with or without sound insulation element.

Advantages/benefits

- The KSU Sets are available in two different versions: KSU without noise reduction pieces and the KSU S with noise reduction pieces.
- The horizontal cantilevers with different lengths and the FCN Clix P8 sliding nut allow a flexible adjustment of the noise protection pieces to simplify the installation.
- The included FCN Clix P10 sliding nut with screws for the fixing of the cantilevers offers the possibility of an easy adjustment and a time saving installation.
- The KSU set consists of finished cut channels for instant use and avoids the accumulation of single pieces.

Properties

- Material channels: steel S250 GD+Z275 (material no. 1.0242) acc. to DIN EN 10346
- Material cantilever arms: steel S235 JR (material no.: 1.0037) acc. to DIN EN 10025
- Zinc plating channels: sendzimir-galvanised
- Zinc plating cantilever arms: electro zinc-plated

5

Installation KSU

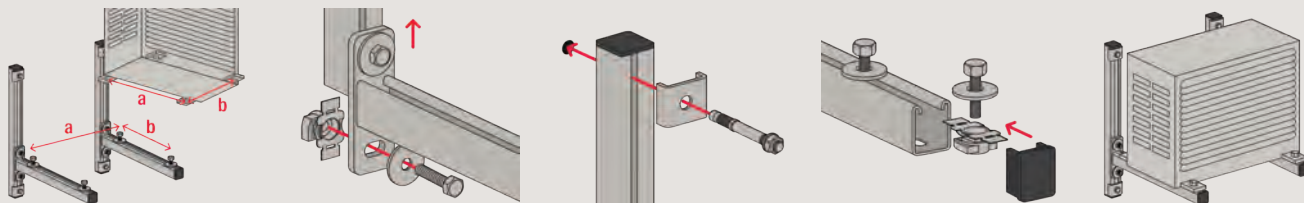

Installation KSU S

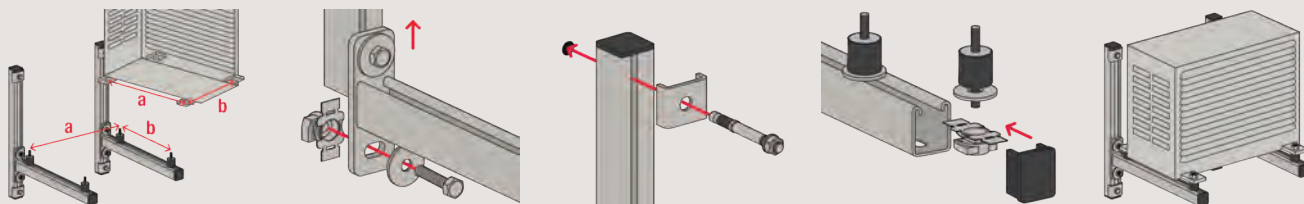

Technical data

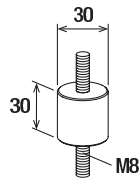
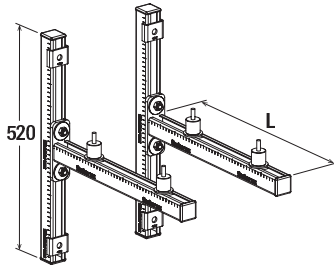

KSU

PA 30 x 30

Item	Item No.	Length	Construction with noise protection	Max. recommended static load load case 1	Max. recommended static load load case 2	Sales unit [pcs]
		L [mm]		F_{rec} [kN]	F_{rec} [kN]	
KSU 450	553733 ¹⁾	450	—	1.5	1.5	1
KSU 500	553734 ¹⁾	500	—	1.5	1.5	1
KSU 600	553735 ¹⁾	600	—	1.5	1.5	1
KSU S 450	553736 ¹⁾	450	yes	1.5	1.5	1
KSU S 500	553737 ¹⁾	500	yes	1.5	1.5	1
KSU S 600	553738 ¹⁾	600	yes	1.5	1.5	1
PA 30 x 30	512715	—	—	—	—	4

1) The loads are valid for the use in pairs (two consoles).

Load case 1

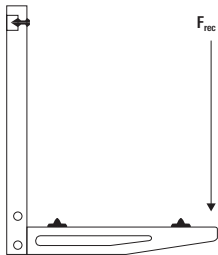

Load case 2

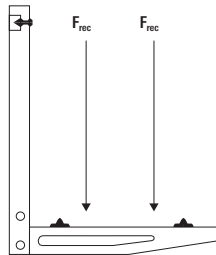

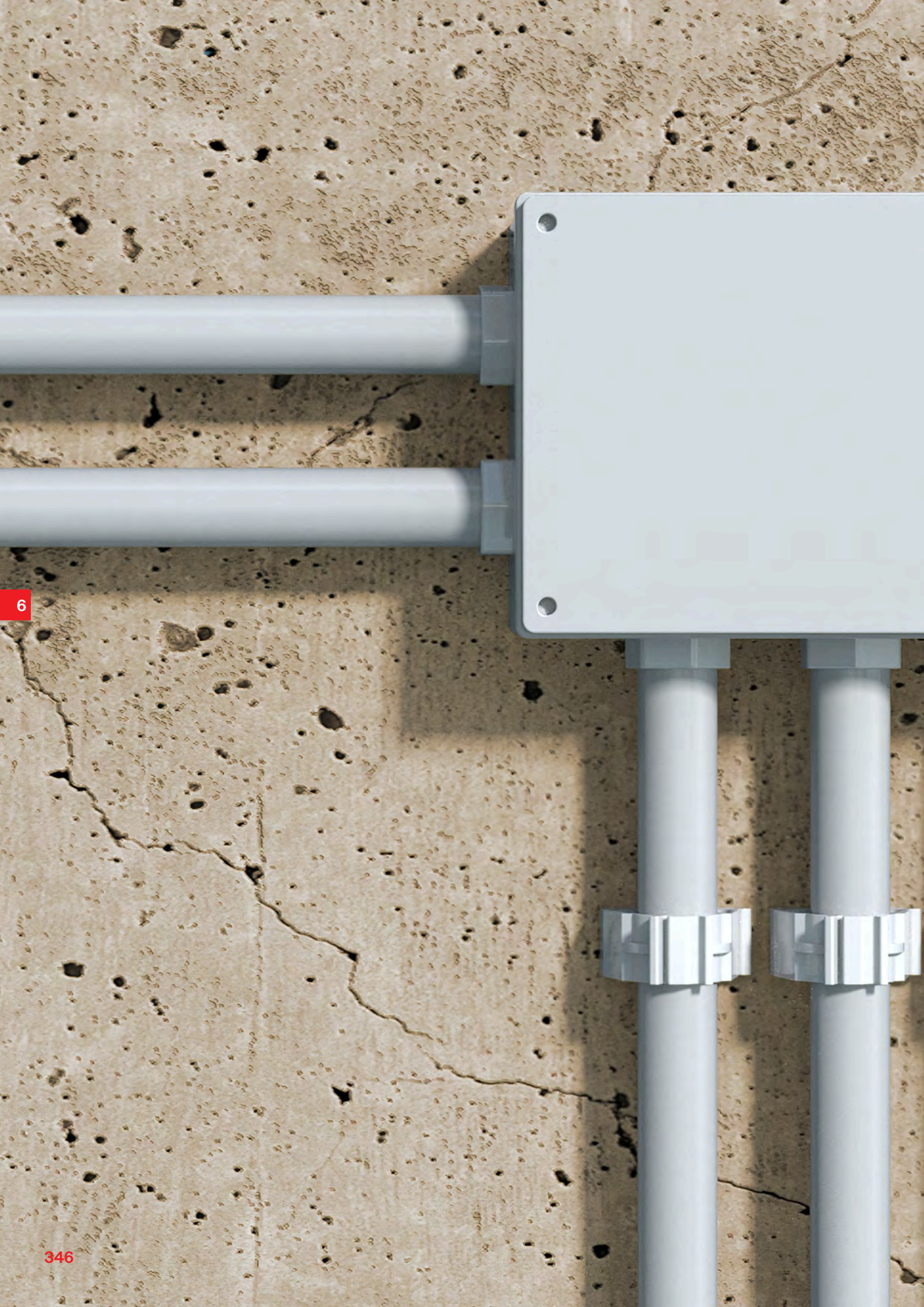





















6

6

Electrical fixings

Locking clip SCN	348		Nail disc NSB	370	
Pipe clip RC	350		Nail clip NS/MNS	372	
Pipe clip FC	352		Spacer pipe clamp AM/AMD	374	
Saddle clip SCH	354		Conduit clip BSM/BSMD/BSMZ	376	
Fastening tie FF	356		Textile web strapping GWB	379	
ClipFix plus LS/ES/ZS	358		Perforated steel banding LBV/LBK	380	
ClipFix plus SD	360		Impact nail ED	382	
Cable clasp KB	362		Cable tie BN/UBN/GBN	384	
Cable harness SHA	364		Cable tie plug FCTP	386	
Multi cable support metal SHA M	366		Wireclip WIC	388	
Wall slot clip FWSC	368				

Locking clip SCN

The easy-to-install and secure locking clip for fixing of pipes



Plastic pipes



Plastic pipes

Applications

- Plastic, empty pipes
- Flexible and rigid electric tubes
- Aluminium-, copper- and steel pipes

Advantages

- When pressing, the locking clip SCN automatically embraces and locks the pipe, thus enabling convenient installation.
- The mechanical lock provides a secure and reopenable fixing.
- The integrated slotted hole allows for an easy and adjustable installation.
- The double-sided couplings allow several

clips to be coupled together. This saves installation time and money.

- Flexible mounting with plugs and screws or with 11 mm C-profile rails.
- The durable nylon material is halogen- and silicone-free, allows year-round use even under frost and thus ensures a high level of safety.

6

Characteristics



Building materials

When using 2-component DuoPower plug:

- Concrete
- Solid brick
- Solid sand-lime brick
- Aerated concrete
- Vertically perforated brick
- Perforated sand-lime brick
- Plasterboard
- Gypsum plasterboard and gypsum fibreboards
- Hollow blocks made from lightweight concrete
- Cavity floor slabs made from bricks and concrete or similar
- Natural stone
- Chipboard
- Solid panel made from gypsum
- Solid brick made from lightweight concrete

Functioning

- The locking clip SCN is fixed in pre-positioned installation with a suitable plug and screw or in 11 mm C-profile rails.
- Due to the mechanical locking, the pipes are securely fixed with the clip.
- Installation temperature $-20\text{ °C} + 60\text{ °C}$
- Temperature resistance when installed -40 °C to $+80\text{ °C}$.

Versions

- Nylon

Installation SCN

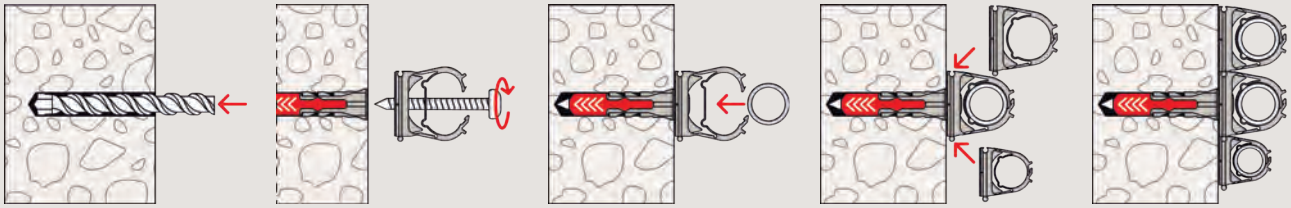

Technical data



Locking clip SCN

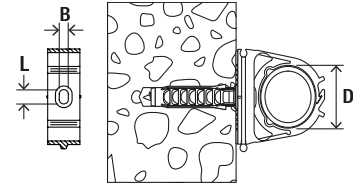

Item	Item No.	Pipe to wall distance [mm]	Clamping range D [mm]	Dimension of slot B x L [mm]	Sales unit [pcs]
SCN 16	501261	11	16	4,5 x 4,5	100
SCN 20	501262	11	20	4,5 x 6,5	100
SCN 25	501263	11	25	4,5 x 6,5	50
SCN 32	501264	13	32	4,5 x 7,5	50
SCN 40	501265	13	40	4,5 x 7,5	25
SCN 50	501266	14	50	4,5 x 7,5	25

Pipe clip RC

The convenient pipe fixing



Fixing plastic insulating conduits



Fixing plastic insulating conduits

Applications

- Flexible and rigid plastic insulating pipes

Advantages

- The pipe clip RC can be used with pre-installed clip fixing SD, with Hammerfix N 6 or in 11 mm C-shaped profile-rails, and thus allows for a flexible and cost-effective installation.
- The 6 mm-long hole allows for the optimal alignment of the pipe fixing and

- ensures a more user-friendly installation.
- Two additional pipe clips can be added to the sides of a pre-fixed pipe clip. This saves assembly time and materials.
- The long-lasting nylon material is halogen- and silicone-free. It can be used all year round, including during a frost. This ensures a high level of safety.

Characteristics



Building materials

When using ClipFix SD:

- Concrete
- Solid pumice block
- Solid sand-lime brick
- Natural stone with dense structure
- Solid brick

Functioning

- Plastic insulation pipes are laid into the pipe clip. The pre-tensioning of the pipe clip holds the pipes securely.
- The pipe clip RC is adapted to be fixed with either clip fixing SD or Hammerfix N 6.
- Manually place the ClipFix plus SD directly into the drill hole. No additional screws are needed.
- The Hammerfix N is expanded when the nail is driven in, and holds by friction in the drill hole.
- Temperature resistance once installed from -20 °C to +80 °C.

Installation RC

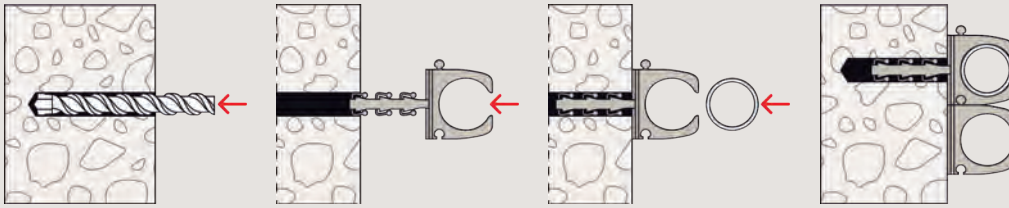

Technical data

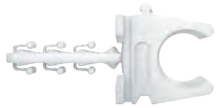

Clipfix plus pipe clip RC



Pipe clip RC PG

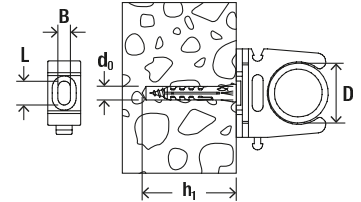
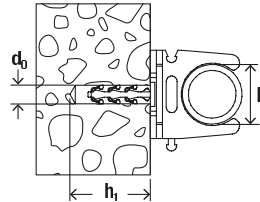

Item	Item No.	Drill hole d_0 [Ø mm]	Min. drill hole depth h_1 [mm]	Suitable for IEC	Clamping range D [mm]	Dimension of slot B x L [mm]	Sales unit [pcs]
SF plus RC IEC 12	048190	6	35	12	12 - 13	6 x 7	100
SF plus RC IEC 16	048191	6	35	16	15 - 16	6 x 8	100
SF plus RC IEC 19	553383	6	35	19	18 - 19	6 x 10	100
SF plus RC IEC 20	048193	6	35	20	20 - 21	6 x 10	100
SF plus RC IEC 25	048197	6	35	25	24 - 25	6 x 10	50
SF plus RC IEC 32	048198	6	35	32	31 - 32	6 x 10	25
SF plus RC IEC 40	048199	6	35	40	38 - 40	6 x 10	25
RC IEC 12	058194	—	—	12	12 - 13	6 x 7	100
RC IEC 16	058120	—	—	16	15 - 16	6 x 8	100
RC IEC 19	553363	—	—	19	18 - 19	6 x 10	100
RC IEC 20	058122	—	—	20	20 - 21	6 x 10	100
RC IEC 25	058198	—	—	25	24 - 25	6 x 10	50
RC IEC 32	058199	—	—	32	31 - 32	6 x 10	40
RC IEC 40	058200	—	—	40	39 - 40	6 x 10	40
RC IEC 50	079194 ¹⁾	—	—	50	50 - 51	6 x 10	20
RC IEC 63	079196 ¹⁾	—	—	63	62 - 64	6 x 10	15

1) Does not include latching catches, therefore cannot be mounted side by side.

Pipe clip FC

The flexible pipe clip for various diameters

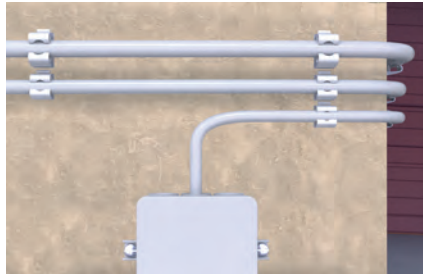

Cable fixing

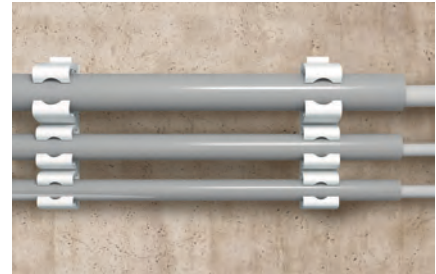

Fixing plastic insulating conduits

Applications

- Electric cables
- Flexible and rigid plastic insulating pipes

Advantages

- The flexible pipe clip socket ensures a secure hold for various cable and pipe diameters, and reduces the number of products required.
- The pipe clip FC can be installed with both N 5 Hammerfixes and 11 mm-C-shaped profile-rails, and thus offers great

flexibility.

- Two additional pipe clips can be added to the sides of a pre-fixed clip clamp. This saves assembly time and materials.
- The long-lasting nylon material is halogen-free. It can be used all year round, including during a frost. This ensures a high level of safety.

6

Characteristics



Building materials

When using Hammerfix N:

- Concrete
- Vertically perforated brick
- Hollow blocks made from lightweight concrete
- Perforated sand-lime brick
- Solid sand-lime brick
- Building brick
- Natural stone
- Aerated concrete
- Solid panel made from gypsum
- Solid brick made from lightweight concrete

Functionality

- The clip clamp FC is adapted to suit the fixture using N5 Hammerfixes.
- The Hammerfix N is expanded when the nail is driven in, and holds by friction in the drill hole.
- The cables or pipes are then laid in the clip clamp FC. The pre-tensioning of the clip clamp holds the cables or pipes securely.
- Temperature resistance once installed from -40 °C to +80 °C.

Installation FC

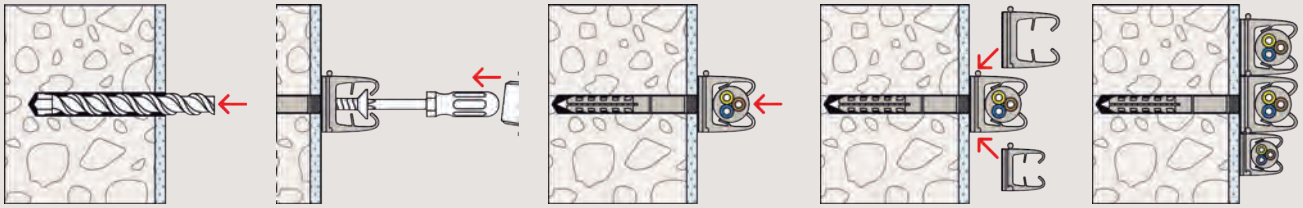

Technical data



Pipe clip FC

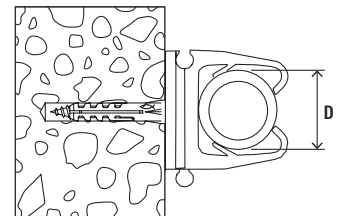

Item	Item No.	Clamping range	Sales unit
		D [mm]	[pcs]
FC 6 - 9 GR	068060	6 - 9	100
FC 9 - 12 GR	068062	9 - 12	100
FC 12 - 16 GR	068064	12 - 16	50
FC 16 - 20 GR	068066	16 - 20	25

Saddle clip SCH

The flexible cable clamp for various diameters

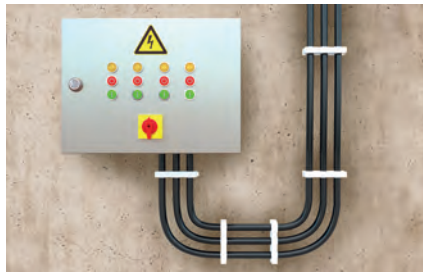

Fixing cable harnesses



Plastic conduits

Applications

- Electric cables
- Flexible and rigid plastic insulating pipes

Advantages

- With its elastic spring tabs, the saddle clip SCH can bear different cable diameters. This increases flexibility and reduces the number of products required.
- Additional clips can be added to the sides of a pre-fixed clip. This saves installation

time and materials.

- The long-lasting nylon material is halogen- and silicone-free. It can be used all year round, including during a frost. This ensures a high level of safety.

Characteristics

6



Building materials

When using Hammerfix N:

- Concrete
- Vertically perforated brick
- Hollow blocks made from lightweight concrete
- Perforated sand-lime brick
- Solid sand-lime brick
- Building brick
- Natural stone
- Aerated concrete
- Solid panel made from gypsum
- Solid brick made from lightweight concrete

Functionality

- The clamp SCH is adapted to suit the fixture using N 5 Hammerfixes.
- The Hammerfix N is expanded when the nail is driven in, and holds by friction in the drill hole.
- The cables or pipes are then laid in the clamp SCH and fixed by inserting the locking latch.
- The internal tabs adapt to fit various cable or pipe diameters.
- Temperature resistance once installed from -40 °C to +80 °C.

Installation SCH

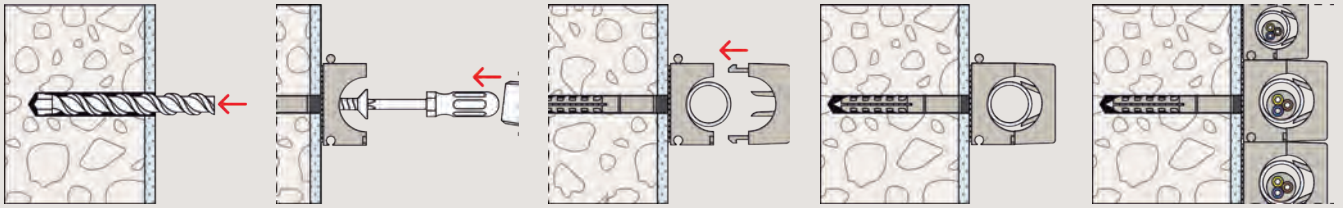

Technical data



Saddle SCH, colour: Nylon transparent



Saddle SCH, colour: grey RAL 7035

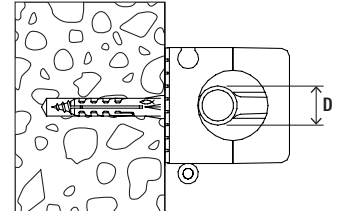

Item	Grey RAL 7035	Nylon transparent	Clamping range D [mm]	Dimension of insulated pipes	Sales unit [pcs]
	Item No.	Item No.			
SCH 812	068012	060012	8 - 12	6 x 1 - 8 x 1	100
SCH 1216	068016	060016	12 - 16	10 x 1 - 12 x 1	50
SCH 1619	068019	069019	16 - 19	—	50
SCH 1623	068023	060023	16 - 23	15 x 1 - 18 x 1	50
SCH 2332	068032	060032	23 - 32	22 x 1 - 22 x 1,5	25
SCH 3242	—	060042	32 - 42	22 x 1 - 22 x 1,5	25

Fastening tie FF

Fixing tie for bundling and fixing of cables and pipes to the substrate

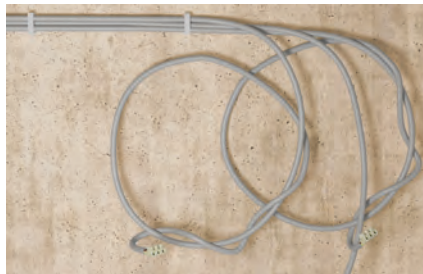

Electric cables



Plastic pipes

Applications

- Electric cables
- Flexible and rigid electric tubes
- Steel conduits

Advantages

- The socket of the FF fixing tie is fixed to the substrate with a screw or screw and plug.
- The fixing tie can be used to bundle and

- fix several cables or pipes.
- Adjustable diameter of the tie loop.
- The socket of the fixing tie can be adjusted through its slotted hole.

Characteristics



6

Building materials

When using 2-component DuoPower plug:

- Concrete
- Solid brick
- Solid sand-lime brick
- Aerated concrete
- Vertically perforated brick
- Perforated sand-lime brick
- Plasterboard
- Gypsum plasterboard and gypsum fibreboards
- Hollow blocks made from lightweight concrete
- Cavity floor slabs made from bricks and concrete or similar
- Natural stone
- Chipboard
- Solid panel made from gypsum
- Solid brick made from lightweight concrete

Functioning

- The Socket of the fixing tie is fixed with the plug and screw suitable for the substrate.
- Recommended application temperature -20 °C to +60 °C.
- Temperature resistant when installed -40 °C to +80 °C.

Installation FF

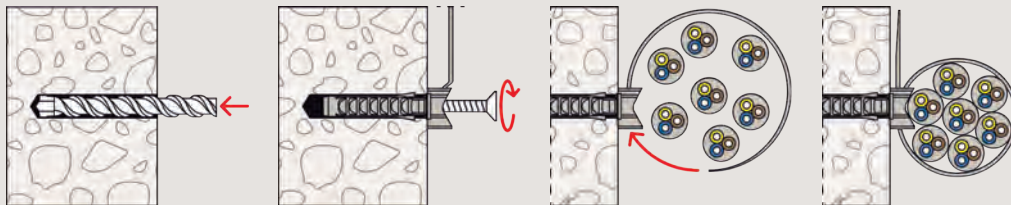

Technical data



Fastening tie FF

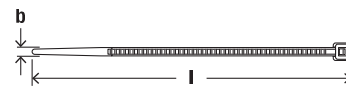

Item	Item No.	Length	Dimension fixing base [mm]	For cables and pipes from / to d_{\min} - d_{\max} [Ø mm]	max. screw diameter [mm]	Sales unit [pcs]
		L [mm]				
FF 8 - 32	519808	172	25 x 15 x 20	8 - 32	4.5	80
FF 16 - 63	519809	270	25 x 15 x 20	16 - 63	4.5	40

ClipFix plus LS/ES/ZS

The user-friendly clip fixing for pipes and conduits



Cable fixing



Fixing flexible pipes

Applications

- Individual electric cables
- Cable bundles
- Flexible pipes
- Rigid plastic pipes

Advantages

- The complete element combines anchor, screw and clamp. This saves materials, allows for one-handed installation, and reduces assembly time.
- The slimline geometry of the fixing element only protrudes slightly, thus saving space.
- The three different sizes of each of the

cable strap LS, twin clamp ZS and single clamp ES cover a range of cable diameters, thus reducing storage.

- The long-lasting nylon material is flame resistant, halogen- and silicone-free, can be used all year round, including during a frost. This ensures a high level of safety.

6

Characteristics



Building materials

- Concrete
- Solid pumice block
- Solid sand-lime brick
- Natural stone with dense structure
- Solid brick

Functioning

- The clip fixing is set into the drill hole without the need for any additional screws and fixes the pipe directly to the base material.
- The clamping force of the locking catch allows the ClipFix to hold itself in the drill hole.
- Place the clasp of the cable strap LS into the drill hole so that it is level and the teeth grip.
- Recommended loads (required safety factor considered): cable strap LS up to 6 kg, twin clamp ZS and single clamp ES up to 11 kg.
- Temperature resistance once installed from -20 °C to +80 °C.
- Flammability material UL 94-V0.

Installation LS/ES/ZS

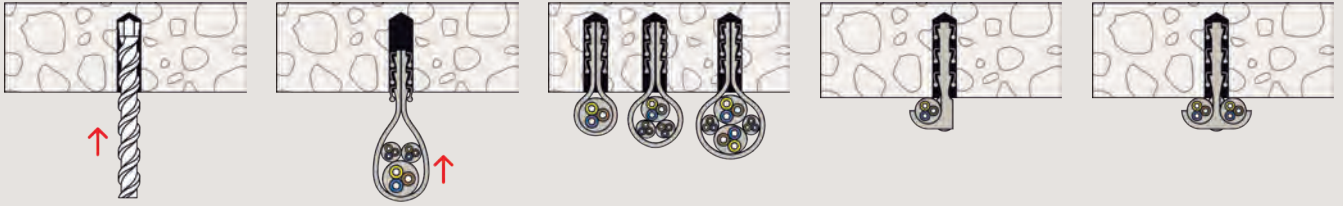

Technical data



Clip fix plus cable strap SF plus LS



Clip fix plus single clamp SF plus ES



ClipFix plus twin clamp SF plus ZS

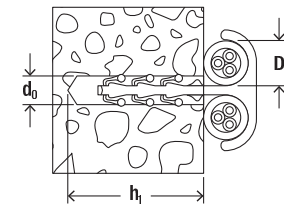
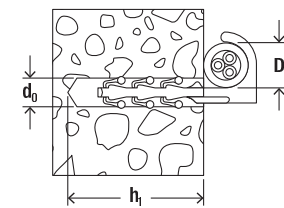
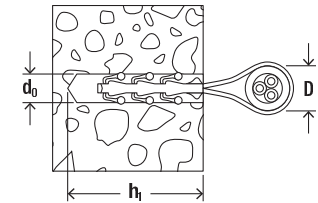

Item	Item No.	Drill hole d_0 [Ø mm]	Min. drill hole depth h_1 [mm]	Clamping range D [mm]	Sales unit [pcs]
SF plus LS 3/13	058155	6	35	3 - 13	100
SF plus LS 8/28	058156	6	50	8 - 28	100
SF plus LS 20/40	058157	6	50	20 - 40	100
SF plus ES 10	048151	6	40	3 - 12	100
SF plus ES 18	048152	6	40	10 - 25	100
SF plus ES 28	058183	6	40	15 - 31	100
SF plus ZS 10	058184	6	35	3 - 12	100
SF plus ZS 18	048161	6	40	10 - 25	100
SF plus ZS 28	048162	6	40	15 - 31	75

ClipFix plus SD

The user-friendly clip fixing for cable ducts and cable clasps

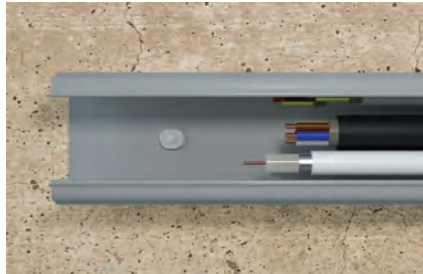

Fixing cable ducts



Fixing cable harnesses

Applications

- Cable channels
- Cable clasps
- Installation base cable harness
- Flat building components

Advantages

- The ClipFix plus SD combines anchor and screw. This saves on materials and makes it easier to affix cable ducts that are difficult to access without the need for additional tools.
- The simple clip fixing reduces installation time.
- The extended shank of the FS plus SD 40

allows bridging of non-bearing plaster layers, as well as the fixing of thicker attachments.

- The long-lasting nylon material is flame resistant, halogen- and silicone-free. It can be used all year round, including during a frost. This ensures a high level of safety.

6

Characteristics



Building materials

- Concrete
- Solid pumice block
- Solid sand-lime brick
- Natural stone with dense structure
- Solid brick

Functioning

- To fix, manually place the ClipFix plus SD directly into the drill hole. No additional screws are needed.
- The clamping force of the locking catch allows the ClipFix to hold itself in the drill hole.
- Recommended loads (required safety factor considered): clip fixing SD up to 11 kg.
- Temperature resistance once installed from -20 °C to +80 °C.
- Flammability material UL 94-V0.

Installation SD

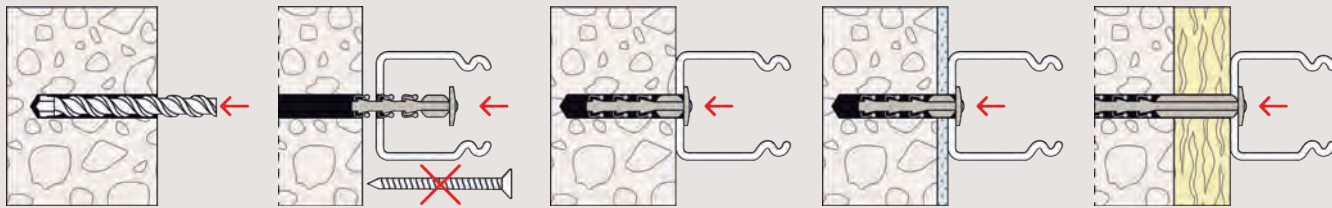

Technical data



fischer ClipFix plus clip fixing
SF plus SD

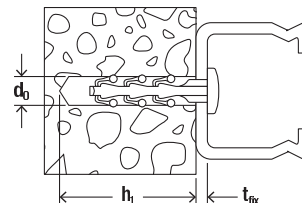

Item	Item No.	Drill hole d_0 [Ø mm]	Min. drill hole depth h_1 [mm]	Max. usable length t_{fix} [mm]	Sales unit [pcs]
SF plus SD 30	058178	6	35	4	200
SF plus SD 40	058179	6	35	15	100

Cable clasp KB

The flat cable clasp for space-saving cable fixing



Fixing cable harnesses



Fixing cable harnesses

Applications

- Several individual cables in a small installation space
- Multiple single cables in false ceilings

Advantages

- The flat design of the KB cable clasp allows for a space-saving cable fixing, and simplifies subsequent cable-laying.
- The combination of cable clasp KB and ClipFix SD allows for one-handed installation, thus enabling a flexible and

economic installation.

- The long-lasting nylon material is halogen- and silicone-free. It can be used all year round, including during a frost. This ensures a high level of safety.

6

Characteristics



Building materials

When using ClipFix SD:

- Concrete
- Solid pumice block
- Solid sand-lime brick
- Natural stone with dense structure
- Solid brick

Functionality

- The cable clasp KB is adapted to suit the fixture with clip fixing SD or Hammerfix N6.
- Place the ClipFix plus SD directly into the drill hole by hand. No additional screws are needed.
- The Hammerfix N is expanded when the nail is driven in, and holds by friction in the drill hole.
- After installation, the cables are pulled under the clasp. Additional cables can be easily laid after installation too.
- Temperature resistance once installed from -20 °C to +80 °C.

Installation KB

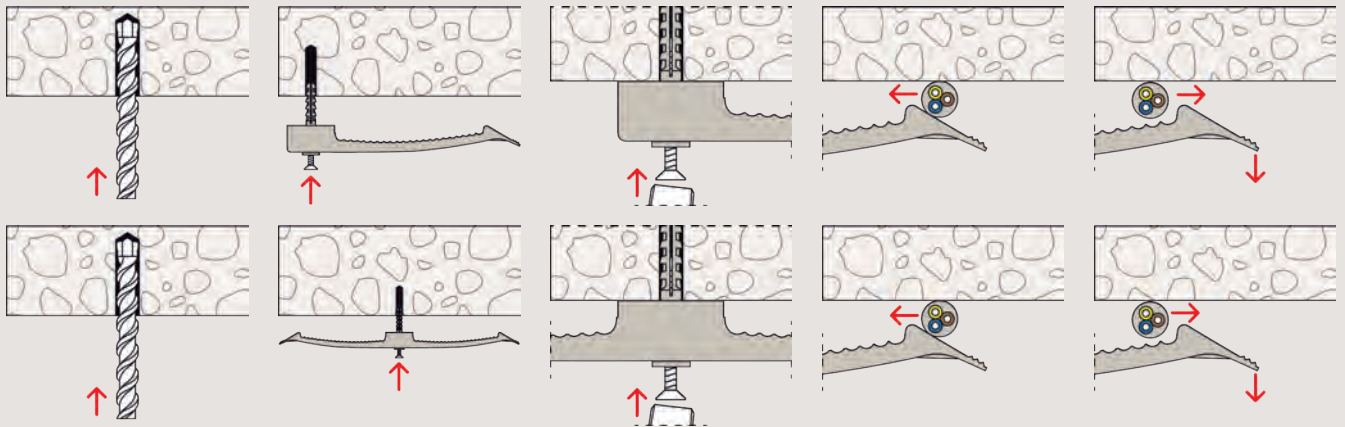

Technical data

Cable clasp with nailplug
KB N 8



Cable clasp with nailplug
KB N 16

ClipFix plus cable clasp SF
plus KB 8

ClipFix plus cable clasp SF
plus KB 16

Cable clasp KB 8

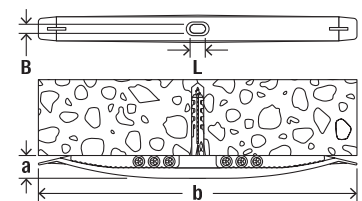
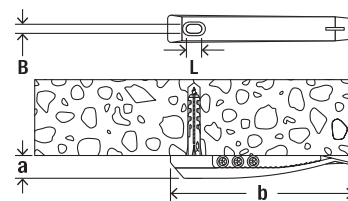
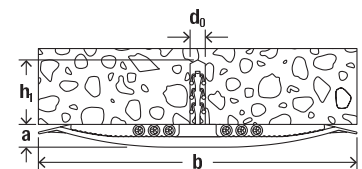
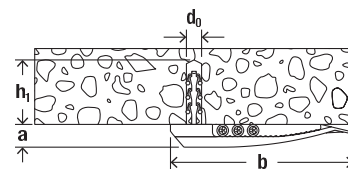
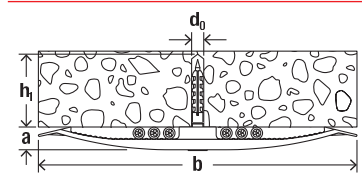
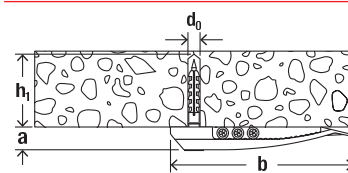

Cable clasp KB 16



Item	Item No.	Drill hole d_0 [Ø mm]	Min. drill hole depth h_1 [mm]	Dimensions $a \times b$ [mm]	Dimension of slot $B \times L$ [mm]	Max. number of ducts	Sales unit [pcs]
SF plus KB 8	048171	6	35	15 x 133	6 x 10	8 ducts NYM 3 x 1,5	50
SF plus KB 16	048172	6	35	15 x 230	6 x 10	16 ducts NYM 3 x 1,5	25
KB 8	058135	—	—	15 x 133	6 x 10	8 ducts NYM 3 x 1,5	50
KB 16	058136	—	—	15 x 230	6 x 10	16 ducts NYM 3 x 1,5	50
KB N 8	545522	6	35	15 x 133	6 x 10	8 ducts NYM 3 x 1,5	50
KB N 16	545523	6	35	15 x 133	6 x 10	16 ducts NYM 3 x 1,5	25

Cable harness SHA

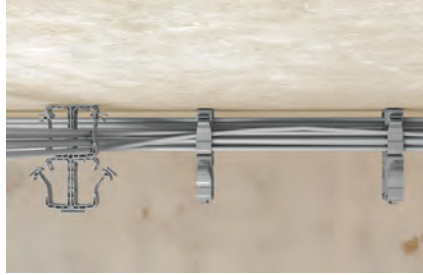
The adaptable cable harness for fixing cable bundles



Fixing cable bundles

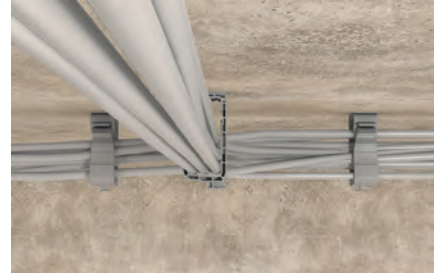

Fixing cable bundles

Applications

- Electric cables, loose and bundled

Advantages

- Simple bundling and economical laying of multiple electric cables.
- The seal of the cable harness SHA makes it easy to lay cables at a later date, thus ensuring high user-friendliness.
- Combining several SHA cable harnesses allows for a cost-effective fixing of cables

- to just one MS installation base.
- The MS installation base allows for various fixing options, and offers great flexibility for the installation.
- The long-lasting nylon material is halogen- and silicone-free, can be used all year round, including during a frost, and thus ensures a high level of safety.

Characteristics



Building materials

When using ClipFix SD:

- Concrete
- Solid pumice block
- Solid sand-lime brick
- Natural stone with dense structure
- Solid brick

Functioning

- Cable bundles can be laid in the cable harness SHA. The seal makes it easy to lay cables at a later date.
- The cable harness SHA can either be affixed with ClipFix plus, installation base MS or with plugs and screws.
- Several SHA cable harnesses can be combined below one another.
- The SHA cable harnesses can also be lined up adjacent to one another with the connection piece SHA KP.
- The maximum installation distance of 80 cm must not be exceeded.
- Temperature resistance once installed from -20 °C to +80 °C.

Installation SHA

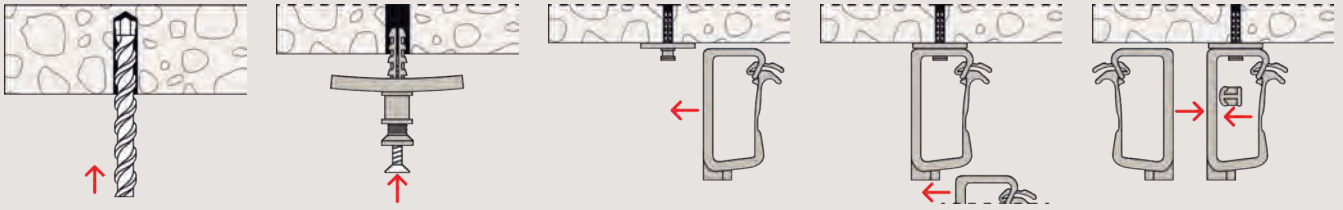

Technical data



Cable harness SHA



Installation base SHA MS



Steckfix plus installation base SF plus MS



Connection piece SHA KP

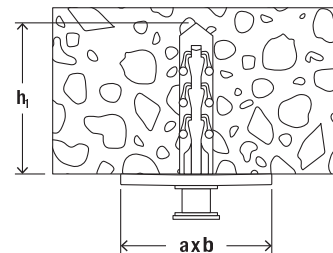
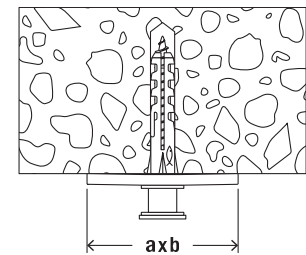
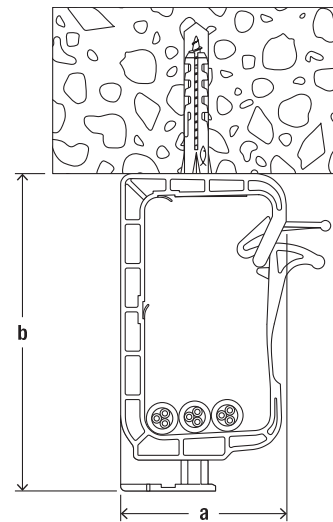

Item	Item No.	Drill hole d_0 [Ø mm]	Min. drill hole depth h_1 [mm]	Dimensions $a \times b$ [mm]	Max. number of ducts	Sales unit [pcs]
SHA 15	058139	—	—	93 x 49	15 ducts NYM 3 x 1,5	50
SHA 30	058140	—	—	128 x 59	30 ducts NYM 3 x 1,5	25
SHA MS	058141	—	—	41 x 27	connection piece	50
SF plus MS	048181	6	35	41 x 27	installation base with clip-plug	50
SHA KP	058142	—	—	—	installation base	50

Multi cable support metal SHA M

Metal multi-cable support with high mechanical resistance and approval



Cable fixing to the ceiling



Cable fixing to the wall

Applications

- Cables with circuit integrity maintenance
- Installation of electrical cables above fire protection ceilings.

Advantages

- The fischer metal multi cable support SHA M has a high mechanical strength and thus offers a long service life and safety in the event of fire.
- It is approved as a cable-specific variant for circuit integrity maintenance of electric cable systems in accordance with DIN 4102 Part 12.
- This makes it suitable for safe installation

- above fire protection ceilings.
- Depending on the version, 15, 30 or 70 cables can be fixed.
- The lock, which can be operated without tools, allows easy subsequent cable-laying and thus ensures a high degree of ease of installation.
- The multi cable support is variably suitable for wall and ceiling installation.
- Halogen-free and without fire load.

Characteristics

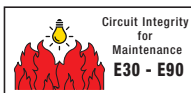

Functioning

- The multi cable support is fixed to walls or ceilings with plugs and screws or metal anchors suitable for the substrate and application.

Installation SHA M

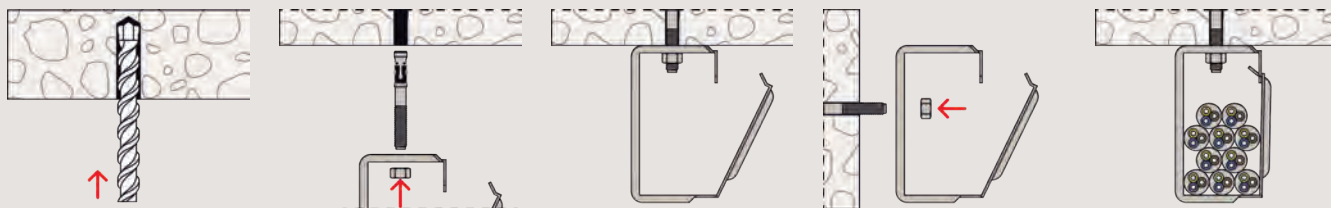

Technical data

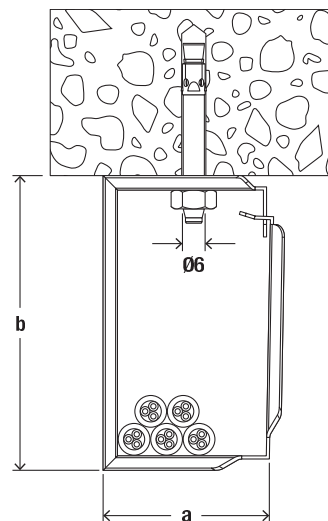
Multi cable support metal
SHA M

Item	Item No.	Mounting pipe Ø [mm]	Dimension in [mm]	Max. number of ducts	Sales unit [pcs]
SHA M 15	544933	6	66,7 x 41,9 x 30,6	15 ducts NYM 3 x 1,5	50
SHA M 30	544934	6	92,8 x 58,1 x 33,6	30 ducts NYM 3 x 1,5	25
SHA M 70	544935	6	126,0 x 104,0 x 80,0	70 ducts NYM 3 x 1,5	10

Wall slot clip FWSC

The quick tool-free cable fixing in wall slots



Cable fixing in wall slots > 30 mm

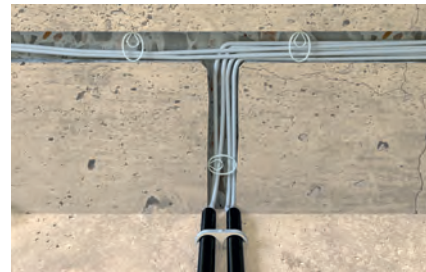

Cable fixing in wall slots < 55 mm

Applications

- Cables in wall slots of 30 - 55 mm width

Advantages

- With the fischer FWSC wall slot clip, cables can be fixed quickly and without tools in wall slots 30 to 55 mm wide.
- This reduces installation time by up to 50%.
- The high expansion power of the wall slot clip guarantees a reliable fixing of the

- cables.
- Damage to the cables can be excluded due to the expansion principle.
- Thanks to its neutral colour, the wall slot clip does not shine through the plaster.
- The wall slot clip is made of halogen-free material.

6

Building materials

- Concrete
- Masonry

Versions

- POM, recyclable

Functioning

- The cables to be fastened are inserted into the wall slot.
- By pressing together the wall slot clip is compressed and tensed to be ready for installation in the wall slot.
- The wall slot clip can be compressed in length or width as required and thus used for wall slots with a width of 30 to 55 mm.

Installation FWSC

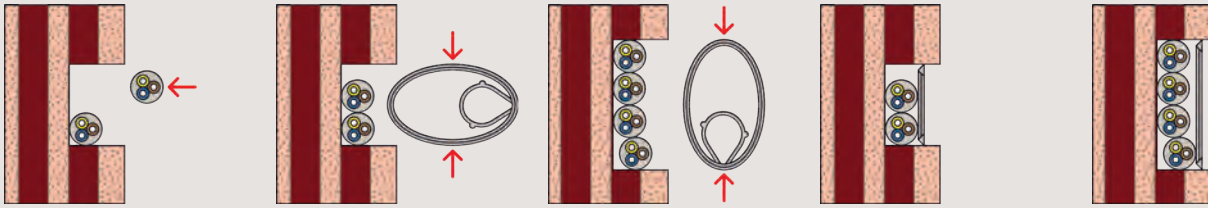

Technical data



Wall slot clip FWSC

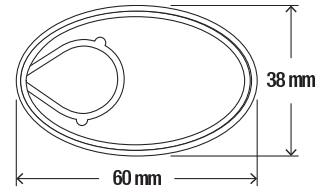

Item	Item No.	Max. slot width [mm]	Dimension in [mm]	Sales unit [pcs]
FWSC 30 - 55	545792	55	38 x 60 x 4	50

Nail disc NSB

The secure cable fixing in wall slots



Cable fixing

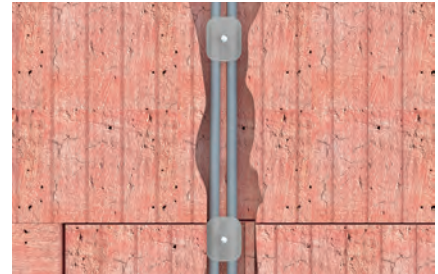

Cable fixing in slits

Applications

- Cables in wall slots

Advantages

- The nail disc NSB allows for use in two slot widths.
- The vaulted structure of the nail disc ensures an optimal contact pressure and, as such, for a secure hold.
- The flat nail disc only protrudes slightly,

- and can thus be easily plastered over.
- The nail disc NSB is made from high-strength polypropylene. The nail is made from hardened, galvanised steel. The tried and tested material combination for in-wall installation.

Building materials

- Vertically perforated brick
- Pumice
- Lightweight aggregate concrete
- Aerated concrete
- Hardboard
- Wood
- Chipboard
- Plywood
- Solid panel made from gypsum

Functionality

- Remove cable.
- Align the nail disc with either dimensions 27 mm or 34 mm, depending on the slot width, and hit the nail in with a hammer.
- The cables are fixed in the wall slots by the curved washer.

Installation NSB

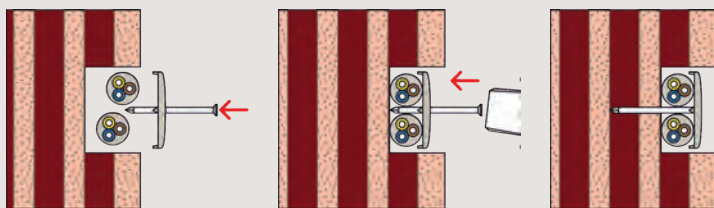

Technical data



Nail disc NSB

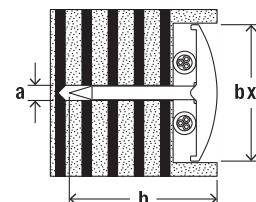

Item	Item No.	Dimension of nail a x b [mm]	Dimension of disc b x l [mm]	Sales unit [pcs]
NSB 2/40	048308	2 x 40	27 x 34	200
NSB 2/50	048309	2 x 50	27 x 34	150
NSB 2/60	048310	2 x 60	27 x 34	100
NSB 3/40	048311	3 x 40	27 x 34	150
NSB 3/50	048312	3 x 50	27 x 34	150
NSB 3/60	048313	3 x 60	27 x 34	100

Nail clip NS/MNS

The fast fixing for electric cables



Cable fixing



Cable fixing

Applications

- Electric cables with varying diameters

Advantages

- The nail clip features a pre-assembled zinc-plated nail, allowing for a fast fixing, thus reducing assembly time.
- The small space required for fixing simplifies

installation in narrow spaces.

- The nail clip MNS covers cable diameters from 4 mm to 14 mm with just 3 sizes.

Building materials

- Hardboard
- Wood
- Aerated concrete
- Chipboard
- Plywood
- Solid gypsum panels and other plastered substrates

Functioning

- Position the nail clip with the laid cable. Hammer in the pre-assembled nail with a hammer.

Installation NS/MNS

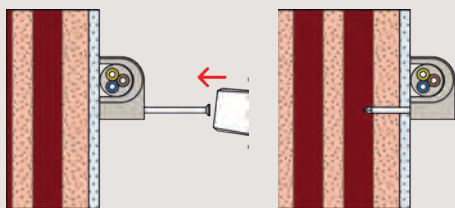

Technical data



Nail clip NS



Nail clip MNS

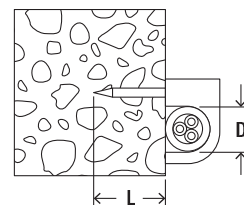

Item	Item No.	For cable [Ø mm]	Clamping range D [mm]	Length of nail L [mm]	Sales unit [pcs]
NS 7	058173	7	7	25	100
NS 8	058174	8	8	25	100
NS 9	058175	9	9	25	100
NS 10	058176	10	10	30	100
NS 12	058177	12	12	35	100
MNS 4-7	094673	—	4 - 7	25	100
MNS 7-11	094674	—	7 - 11	25	100
MNS 10-14	094675	—	10 - 14	30	100

Spacer pipe clamp AM/AMD

The installation-friendly metal spacing disc for cables and pipes



Fixing steel armoured conduits



Fixing conduits

Applications

- Steel conduits
- Electric cables
- Copper and metal pipes

Advantages

- The fast-locking latch ensures easy opening and closing without completely removing the screw, and allows for a simple and fast installation.
- The pre-fitted combination screw with

conventional slotted or recessed screw head allows for the use of different screwdrivers, thus allowing for a simple installation.

Building materials

When using nail anchor FNA II:

- Concrete
- Solid sand-lime brick
- Natural stone with dense structure
- Pre-stressed concrete hollow slabs

When using Hammerfix N:

- Concrete
- Solid sand-lime brick
- Building brick
- Natural stone
- Solid brick made from lightweight concrete

Functioning

- The spacer clamp AM with M6 thread can either be affixed with fischer nail anchor FNA II 6x30 M6x43, stud screw STST 6x60 and STST 6x80 or with Hammerfix N 6x40/10 M6.

Installation AM/AMD

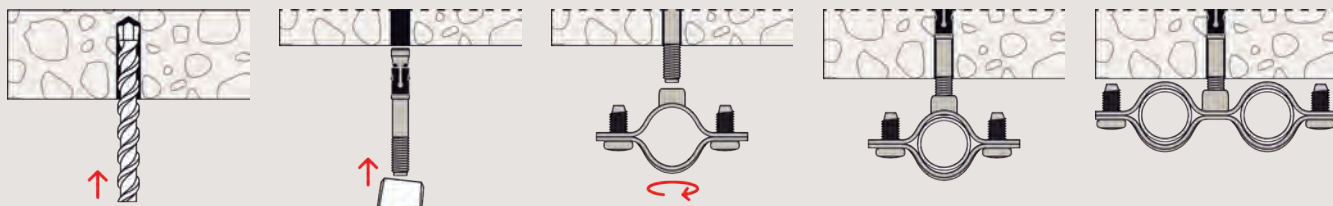

Technical data



Metal two-piece pipe clamp AM

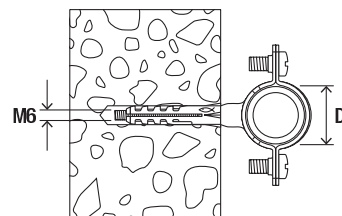

Item	Item No.	Dimension IEC	Clamping range D [mm]	Sales unit [pcs]
AM 8	060185	—	8 - 10	50
AM 10	060186	—	10 - 11	50
AM 12	060187	12	12 - 13	50
AM 14	060188	—	14 - 15	50
AM 16	060189	16	15 - 17	50
AM 18	060190	—	18 - 19	50
AM 20	060191	20	20 - 21	50
AM 22	060192	—	22 - 23	50
AM 24	060193	—	24 - 25	50
AM 26	060194	25	26 - 27	50
AM 28	060195	—	28 - 29	50
AM 30	060196	—	30 - 31	50
AM 32	060209	32	32 - 33	25
AM 34	060210	—	34 - 35	25
AM 37	060211	37	37 - 39	20
AM 40	090849	40	40 - 42	15
AM 50	090850	50	50 - 52	10
AM 63	090851	63	63 - 65	10

6

Technical data



Metal two-piece pipe clamp AMD

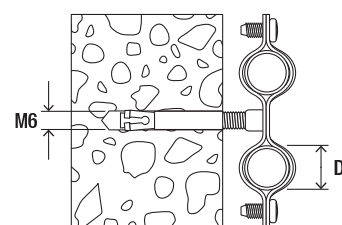

Item	Item No.	Clamping range D [mm]	Sales unit [pcs]
AMD 10 - 12	545772	10 - 12	25
AMD 14 - 16	545773	14 - 16	25
AMD 17 - 19	545774	17 - 19	25
AMD 20 - 23	545775	20 - 23	25
AMD 24 - 27	545776	24 - 27	25

Conduit clip BSM/BSMD/BSMZ

The flat metal clip for cables and pipes



Fixing armoured conduits

Applications

- Electrical conduits
- Flexible and rigid plastic insulating pipes
- Steel conduits

Advantages

- The open conduit clip BSM is ideal for the post-installation fixing of conduits.
- The conduit clip allows for a direct fixing with impact nails and is, therefore, quick

and easy to install.

- Two conduits or pipes can be fixed with just one fixing point with the twin clamp BSMZ.

Building materials

When using impact nail ED:

- Concrete

Functioning

- Depending on your requirements, use a conduit clip with 1 or 2 fixing points, or a twin clamp.
- The conduits or pipes are laid in the conduit clip. Assembling the clip fixes the conduits / pipes.
- Our recommendation for fixtures on concrete: Impact nail.

Installation BSM/BSMD/BSMZ



Technical data

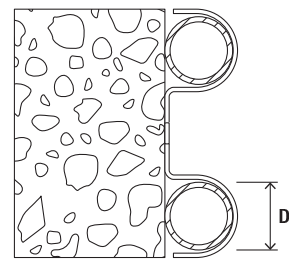
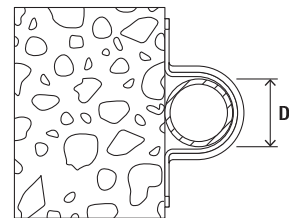
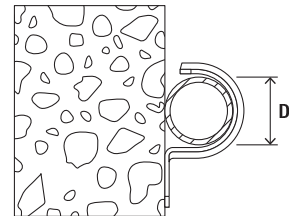

6

Item	BSM Item No.	BSMD Item No.	BSMZ Item No.	Dimension IEC	Clamping range D [mm]	Sales unit [pcs]
6	015014	—	—	—	6	100
8	015015	—	—	—	8	100
10	015016	—	—	—	10	100
10	—	015068	—	—	10	50
12	015017	015069	—	—	12	50
14	015018	015070	—	—	14	50
15	015093	—	—	15	15	50
16	060149	060169	—	16	16	50
18	060150	060170	—	—	18	50
20	060151	060171	079535	20	20	50
22	060152	060172	—	—	22	50
24	060153	—	079536	—	24	50
25	090839	090844	—	25	25	50
26	096958	015076	—	—	26	50
28	—	060175	—	—	28	25
28	060155	—	079537	—	28	50
30	015019	—	—	—	30	50
32	090840	—	—	32	32	50
32	—	090845	—	32	32	25
37	060158	060178	—	—	37	25
40	090841	090846	—	40	40	25

Technical data



Conduit clip BSM



Conduit clip BSMD



Conduit clip BSMZ

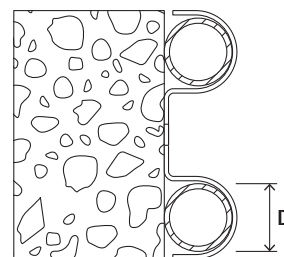
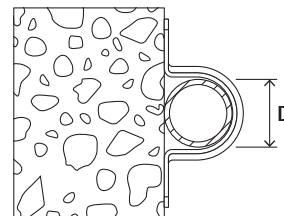
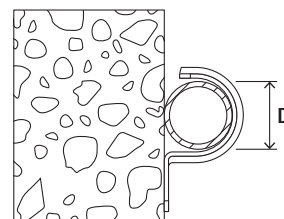

Item	BSM	BSMD	BSMZ	Dimension IEC	Clamping range D [mm]	Sales unit [pcs]
	Item No.	Item No.	Item No.			
42	—	015081	—	—	42	20
42	015021	—	—	—	42	25
47	—	015082	—	—	47	20
50	090842	—	—	50	50	20
50	—	090847	—	50	50	15
63	—	090848	—	63	63	10
63	090843	—	—	63	63	15

Textile web strapping GWB

Textile web strapping GWB for cost-effective, easy pipe fixings



Flexible and rigid plastic insulation pipes

Applications

- Pipelines
- Flexible and rigid plastic pipes
- Compound pipes

Properties

- Material: polypropylene

Advantages/benefits

- Pipe fastening using textile tape allows cheap and simple installation.
- The textile tape roll allows the correct tape length to be chosen to suit the diam-

- eter in question.
- Hangings with textile tape are a fast solution for temporary fixings.

Building materials

When using impact nail ED:

- Concrete

6

Installation GWB

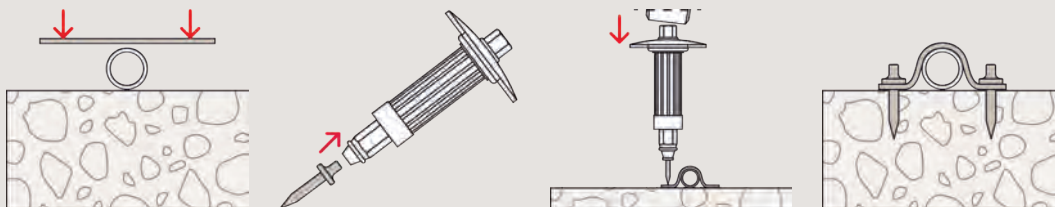

Technical data



GWB

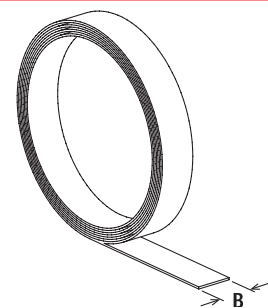

Item	Item No.	Total length l [mm]	Width B [mm]	Thickness S [mm]	Sales unit [pcs]
GWB	020959	10000	15	1.1	10

Perforated steel banding LBV/LBK

Perforated steel banding LBV / LBK for the fast fixing of pipelines



Plastic pipes

Applications

- Pipelines
- Flexible and rigid plastic pipes
- Compound pipes

Properties

- Material: DX51D+Z 100 (material no. 1.0917) acc. to DIN EN 10.346 For Type LBW17: Q235
- Zinc plating: electro zinc-plated, min. 5 µm
- Protective coating LBK: PE

Advantages/benefits

- The perforated tape's material thicknesses and plastic covering allows the tapes to be easily cut to size using metal shears.
- The perforated tape's hole geometry enables concrete fixing using the fischer impact nail ED.

Building materials

- When using impact nail ED:
- Concrete

Installation LBV/LBK

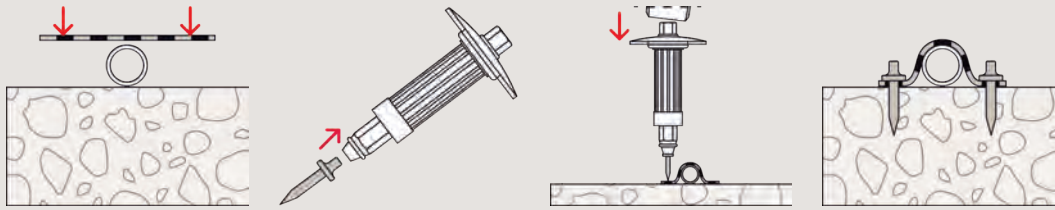

Technical data



LBV



Type LBK

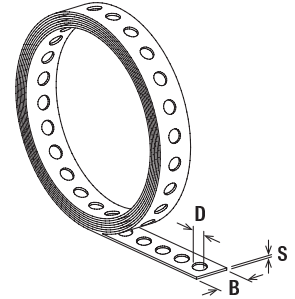

Item	Item No.	Total length l [mm]	Width B [mm]	Thickness S [mm]	Eye-Ø D [mm]	Sales unit [pcs]
LBV 12	079549	10000	12	0.75	5	10
LBV 17	079550	10000	17	0.75	6.5	10
LBV 25	079551	10000	25	0.88	8.5	8
LBK 14	079553	10000	14	2.6	5	10
LBK 19	079554	10000	19	2.4	6.5	8
LBK 27	079555	10000	27	2.4	8.5	5

Impact nail ED

Fixing in concrete without pre-drilling



Fixing armoured conduits



Fixing perforated tapes

Applications

- Conduit clips such as BSM, BSMD, BSMZ
- Perforated band such as LBK, LBV

Advantages

- The stable impact nail ED can be set in concrete with the impact nail setting tool SZE without pre-drilling. This allows for a

fast installation.

- The setting tool SZE impact protection provides the best protection for your hand, thus ensuring a safe installation.

Building materials

- Concrete

Functionality

- The impact nail ED is set in the setting tool SZE.
- The bracket in the setting tool holds the nail securely in place during the installation procedure.
- Pre-positioning of the element to be fixed.
- The nail can be hammered through the fixing element directly into the concrete.

Installation ED

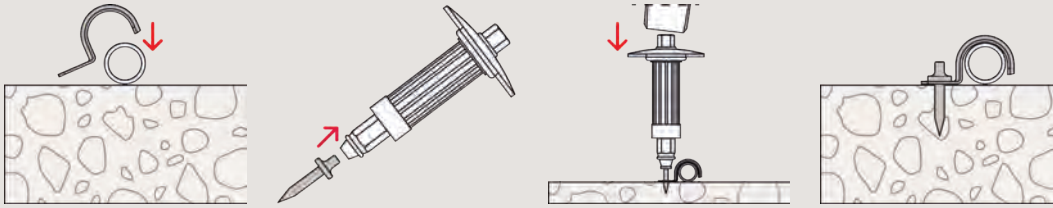

Technical data



ED

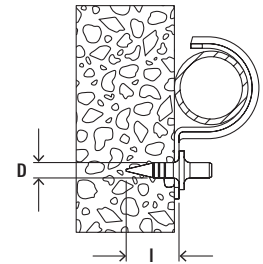

Item	Item No.	Length L [mm]	Diameter d [mm]	Sales unit [pcs]
ED 15	048212	15	4.0	200
ED 18	079815	18	4.0	200
ED 22	014570	22	4.0	200

Technical data



SZE

Toolset for SZE

Item	Item No.	Sales unit [pcs]
SZE	552149	1
Toolset for SZE	552150	3

Cable tie BN/UBN/GBN

For the simple bundling of cables and pipes



Bundling electric cables



Electric cables

Applications

For bundling of:

- Electric cables
- Flexible and rigid plastic insulating pipes
- Steel conduits

Advantages

- The long-lasting nylon material is halogen- and silicone-free.
- The cable tie UBN (black) is made from

UV-stabilised material.

Characteristics

6



Functioning

- Lie the cable tie around the object to be fixed, and pull the band through the head of the cable tie. The cable tie can no longer be opened due to the latching of the tab in the teeth.
- Temperature resistance once installed from -10 °C to +85 °C.
- Recommended installation temperature from -10 °C to +85 °C.
- Flammability material UL 94-V2.

Installation BN/UBN/GBN

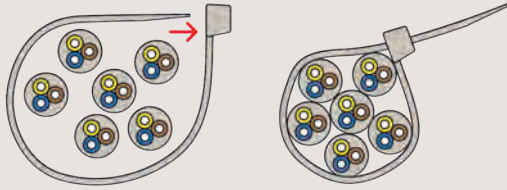

Technical data

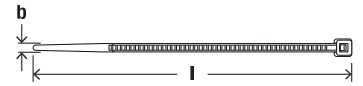
Cable tie UBN,
colour: blackCable tie BN,
colour: transparentCable tie GBN,
colour: green

Item	Colour: black	Colour: transparent	Colour: green	Dimensions [mm]	Sales unit [pcs]	Outer carton [pcs]
	Item No.	Item No.	Item No. ETA			
BN/UBN/GBN 2,5 x 100	087488	087478	543924	2,5 x 100	100	20000
BN/UBN 2,5 x 120	087489	087479	—	2,5 x 120	100	15000
GBN 2,5 x 150	—	—	543925	2,5 x 150	100	20000
BN/UBN/GBN 2,5 x 200	087490	087480	543926	2,5 x 200	100	10000
BN/UBN 2,5 x 160	069363	037489	—	2,5 x 160	100	20000
BN/UBN/GBN 3,6 x 150	087491	087481	543927	3,6 x 150	100	10000
BN/UBN 3,6 x 200	037573	019802	—	3,6 x 200	100	10000
BN/UBN 3,6 x 300	069364	037490	—	3,6 x 300	100	7500
BN/UBN 4,6 x 160	069365	037501	—	4,6 x 160	100	10000
BN/UBN 4,6 x 190	069366	037581	—	4,6 x 190	100	10000
BN/UBN/GBN 4,6 x 200	087494	087484	543928	4,6 x 200	100	7500
BN/UBN 4,8 x 250	069367	—	—	4,8 x 250	100	5000
BN/UBN 4,8 x 250	—	037582	—	4,8 x 250	100	5000
BN/UBN/GBN 4,8 x 280	087495	087485	543929	4,8 x 280	100	5000
BN/UBN 4,8 x 350	069368	037653	—	4,8 x 350	100	5000
BN/UBN 4,8 x 370	069369	037583	—	4,8 x 370	100	5000
BN/UBN 4,8 x 430	069370	037708	—	4,8 x 430	100	5000
BN/UBN 7,6 x 200	069372	037945	—	7,6 x 200	100	4500
BN/UBN 7,6 x 300	069373	037949	—	7,6 x 300	100	2500
BN/UBN 7,6 x 350	087497	087487	—	7,6 x 350	100	2500
BN/UBN 7,6 x 450	069374	037996	—	7,6 x 450	100	2500
BN/UBN 7,6 x 550	069375	037997	—	7,6 x 550	100	2000
BN/UBN 8,8 x 760	069376	037998	—	8,8 x 760	100	1000
BN/UBN 8,8 x 810	069377	038000	—	8,8 x 810	100	1000
BN/UBN 8,8 x 1168	069379	038002	—	8,8 x 1168	100	500

Cable tie plug FCTP

The universal fixing point for cable ties



Electric cables



Flexible and rigid plastic pipes

Applications

- Universal fixing point for fixing of cables and pipes using cable ties

Advantages

- The FCTP cable tie plug combines the function of a plug and an eyelet to which cable ties up to 9.5 mm width can be attached (e.g. fischer BN or UBN).
- It offers a universal fixing point to which various cables and pipes can be at-

tached.

- Installation is simple and time-saving by driving the plug into the drill hole.
- The lamellas of the plug ensure a secure hold in the building material and thus fix the cable tie in the intended position.

Building materials

- Concrete
- Solid brick
- Solid sand-lime brick

Versions

- Nylon, halogen-free

Functioning

- The cable tie plug can be hammer set.
- A cable tie is inserted through the eyelet and the object to be fastened is fixed in the intended position.
- The eyelet with a width of 9.5 mm and a height of 3 mm is suitable for all fischer cable ties.

Installation FCTP

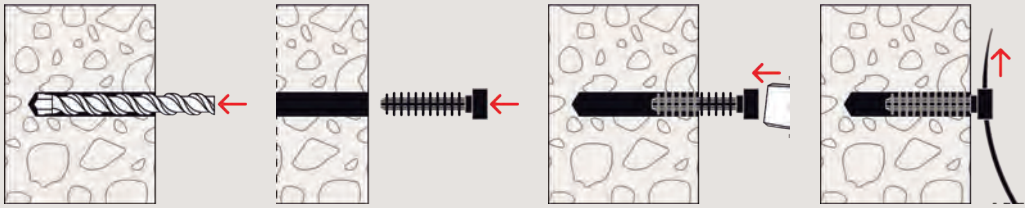

Technical data



Cable tie plug FCTP

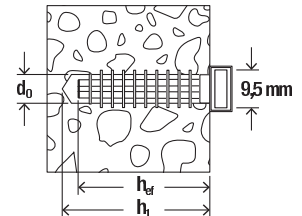

Item	Item No.	Drill diameter d_0 [mm]	Min. drill hole depth h_1 [mm]	Anchorage depth h_{ef} [mm]	Total length l [mm]	Sales unit [pcs]
FCTP-W	545786	8	40	35	45	100
FCTP-B	545787	8	40	35	45	100

Wireclip WIC

Infinitely variable fixing of wire suspensions



Suspension of signs



Suspensions for trade show exhibits

Applications

For suspension of:

- Lighting strips
- Cable trays
- Ventilation ducts
- Pipes
- Signs
- Chilled ceilings

Advantages

- The simple system guarantees ease of use.
- The Wireclip's simple closing mechanism means that no tools are needed. This

allows for a cost-effective installation.

- The reclosable Wireclips make it possible to adjust the length at any time. This guarantees the greatest flexibility.

6

Functionality

- Loops are formed from the wire, which can be threaded through the wireclip. This allows objects to be hung. The wireclips can be adjusted at any time.
- The FNA II 6x25 OE is suitable for fixing the wire.

Note:

- Do not apply paint or any other coating.
- Do not apply lubricant.
- Do not use for lifting loads.
- Remove damaged wire ends using the wire cutter WIZ prior to introducing wires into the wire clip.

Installation WIC



Technical data



WIC 2



WIC 3



WIC 4

Item	Item No.	Wire-Ø [mm]	Sales unit [pcs]
WIC 4 VE50	044564	3 - 4	50
WIC 3 VE20	044561	2,5 - 3,5	20
WIC 2 VE100	044560	2 - 2,5	100
WIC 2 VE20	044559	2 - 2,5	20

Technical data



WIS cable set with eyelet



Wire cutter WIZ

Item	Item No.	Cable length [m]	Wire-Ø [mm]	Sales unit [pcs]
WIS 2/1	045956	1	2	10
WIS 2/2	045957	2	2	10
WIS 2/3	045958	3	2	10
WIS 2/5	045959	5	2	10
WIS 2/10	045960	10	2	10
WI Ø 2 mm	044565 ¹⁾	200	2	1
WIZ	044721	—	—	1

1) on a roll

Loads

Wireclip

Recommended loads¹⁾ per Wireclip.

Type	Diameter of wire cable	Recommended tension load N_{rec}
	[mm]	[kN]
WIS complete system	2.0	0.5
WIC 2 ²⁾	2.0	0.6
WIC 2 ²⁾	2.5	1.0
WIC 3 ²⁾	3.0	1.2
WIC 4 ²⁾	4.0	2.3

¹⁾ Required safety factors are considered.

²⁾ Only in combination with fischer wire cable.



7

7

Sanitary fixings

Sanitary fixings for board materials

392



Ceramic fixings

394



Wash basin and urinal fixings

397



Sanitary fixings for board materials

Complete fixing sets for wash basins and urinals in board building materials and plumbing walls



Urinals



Wash basins

Applications

- Wash basins
- Urinals

Advantages

- With their special geometries, KM and WDP are the specialists for fixings in plumbing and hollow walls.
- The wide transition beams of the KM and

the large base plate of the WDP ensure a good load distribution, thus allowing for a high load-bearing capacity.

Building materials

- Gypsum plasterboard and gypsum fibreboards
- Chipboard

Functioning

- KM is suitable for push-through installation.
- When placed in the drill hole, the wide transition beam of the KM independently swings open behind the board.
- WDP is set into the plumbing walls during wall installation.

Installation WDP

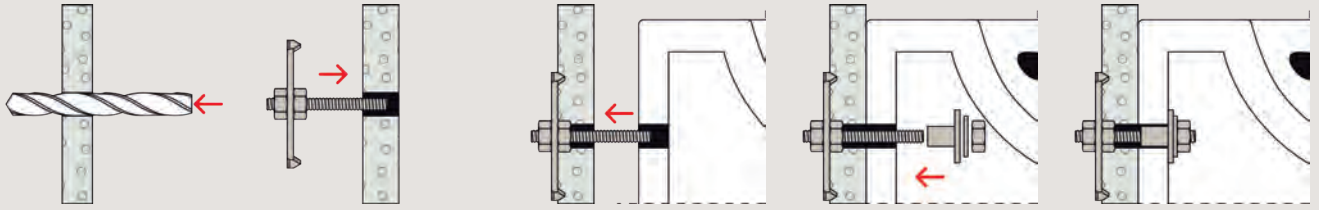

Installation KM

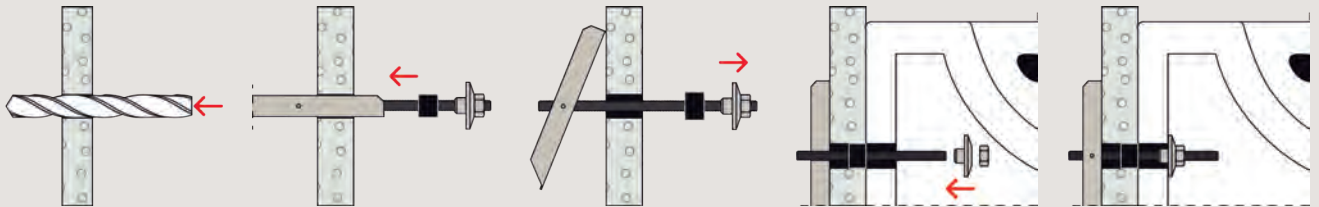

Technical data



Wash basin and urinal fixing
WDP

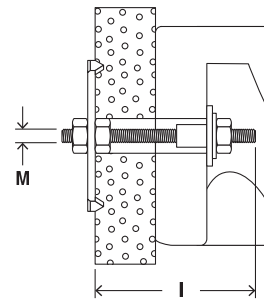

7

Item	Item No.	Contents per plastic bag	Sales unit
		[pcs]	[pcs]
WDP 10 x 170	014320	2 Threaded rods M10 x 170 with base plate 60x60x3, 2 flanged bushes BDH M10, 2 hexagon nuts M10 zinc-plated	10

Technical data

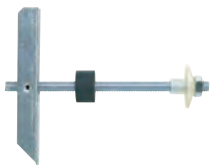

Gravity toggle KM 10

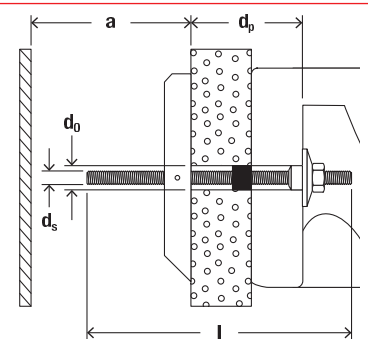

Item	Item No.	Drill hole diameter	Anchor length	Min. cavity depth	Max. panel thickness	Screw	Sales unit
		d_0 [mm]	l [mm]	a [mm]	d_p [mm]	$d_s \times l_s$ [mm]	[pcs]
KM 10	050326	30	180	140	90	M 10 x 180	25

Ceramic fixings

Complete fixing sets for free-standing toilets and bidets

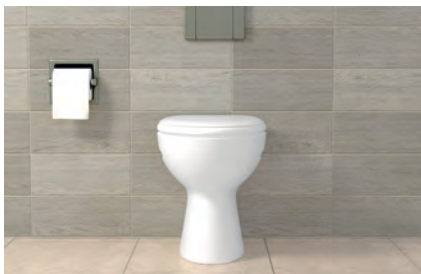

Free-standing toilets



Bidets

Applications

- Free-standing toilets
- Bidets
- Ceramic shelves
- Mirrors

Advantages

- Complete fixing sets including brass screws allow for quick and easy installation.
- A pronounced rim prevents contact between the screw and ceramics, thus ensuring nothing gets damaged during

fixing.

- The WB5N's assembly bracket with pre-drilled rows of holes allows for a flexible fixing with two directions.
- The WCN is also suitable for fixing ceramic shelves and mirrors, and can thus be used for a wide range of applications.

7

Characteristics



Building materials

- Concrete
- Solid sand-lime brick
- Natural stone with dense structure
- Solid brick made from lightweight concrete
- Solid brick

Functioning

- S 8 RD is suitable for push-through installation.
- WCN and S 8 D are suitable for both pre-positioned and push-through installation.
- The WB5N's assembly bracket is flexibly positioned on the base using the long hole. The ceramics are then fixed to the bracket via the rows of holes. These counterbalance any height differences in the ceramic assembly holes.

Installation WCN / S 8 D 70 WCR / S 8 RD WCR

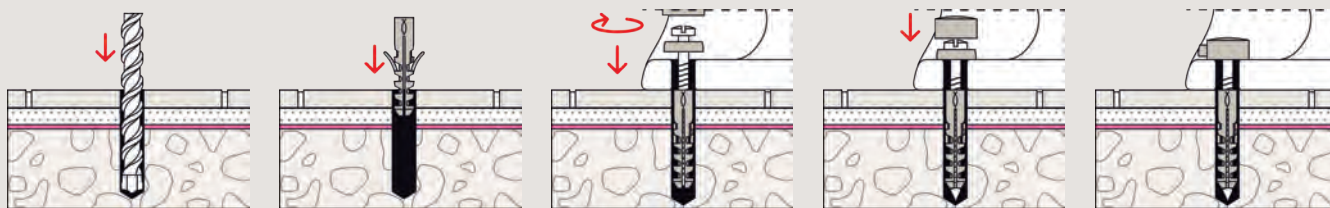

Installation WB 5N

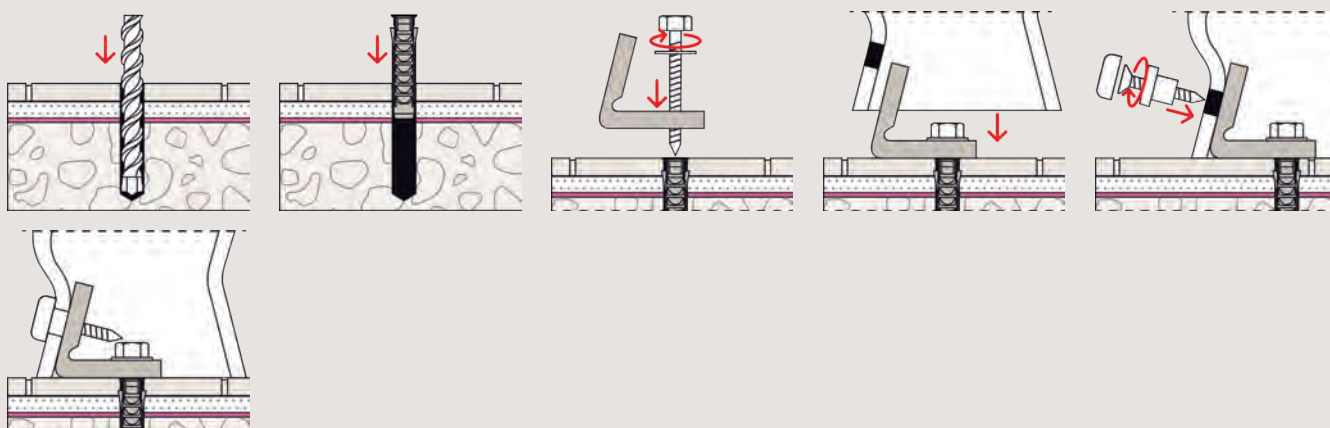

Technical data



WCN

Item	Item No.	Contents per plastic bag [pcs]	Sales unit [pcs]
WCN 2	060562	2 wall plugs S 8, 2 stainless steel screws 6 x 70 hex., 2 cover caps chrome, 2 snap-fit sleeves	50
WCN 1	060561	2 wall plugs S 8, 2 stainless steel screws 6 x 70 hex., 2 cover caps white, 2 snap-fit sleeves	50

Technical data



S 8 D 70 WCR

Item	Item No.	Contents per plastic bag [pcs]	Sales unit [pcs]
S 8 D 70 WCR	060564	2 wall plugs S 8, 2 stainless steel screws 6 x 70 hex., 2 cover caps chrome and white, 2 snap-fit sleeves	50

Technical data



S 8 RD WCR

Item	Item No.	Contents per plastic bag [pcs]	Sales unit [pcs]
S 8 RD 60 WCR	060570	2 wall plugs S 8 RD 60, 2 stainless steel screws 6 x 65 hex., 2 cover caps chrome and white	50
S 8 RD 80 WCR	060568	2 wall plugs S 8 RD 80, 2 stainless steel screws 6 x 85 hex., 2 cover caps chrome and white	50

Technical data



WC fixing WB 5N

Item	Item No.	Contents	Sales unit [pcs]
WB 5N	018652	2 S plugs SX 10, 2 Screws 7x65 zinc-plated, 2 Nylon angles, 2 washers 8mm, 2 screws A2 stainless steel, 2 flanged sleeves, 2 cover caps chrom	50

7

Wash basin and urinal fixings

Complete fixing sets for wash basins, urinals and sanitary installations



Urinals



Wash basins

Applications

- Wash basins
- Urinals
- Built-in toilets
- Boilers
- Gas heaters
- Cisterns
- Consoles

Characteristics



Advantages

- Complete fixing sets allow for quick and easy installation.
- The universal plug UX can be used in solid and hollow materials, thus offering a high level of flexibility.
- Flanged nuts and collar sleeves made of high-strength nylon are resistant to

Building materials

- Concrete
- Vertically perforated brick
- Hollow blocks made from lightweight concrete
- Perforated sand-lime brick
- Solid sand-lime brick
- Natural stone
- Aerated concrete
- Solid panel made from gypsum
- Solid brick made from lightweight concrete
- Solid brick

ageing and chemicals, and guarantee a long-lasting fixing that will not damage the ceramics.

- Cover caps with a high-quality chrome finish ensure the fixture remains visually attractive for a long period of time.

Functioning

- The rimless UX is suitable for pre-positioned and push-through installation.
- Screwing in the screw causes the UX to expand in solid and hollow building material.
- Maximum load-bearing capacity is only achieved when the minimum screw-in depth is reached.
- Tiles and plaster are not classed as load-bearing base materials.

Installation WD/BO/WST/UST

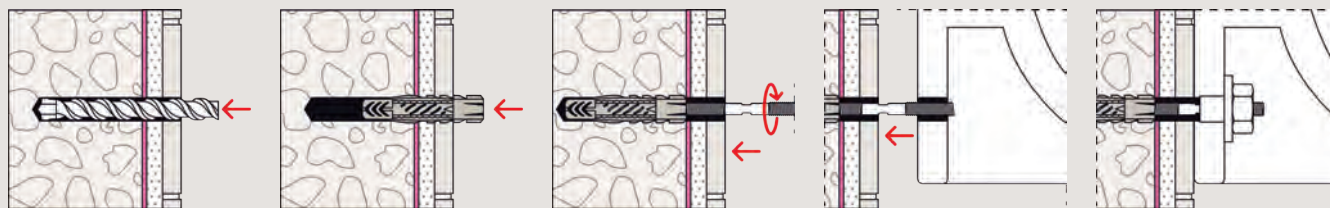

Technical data



Wash basin and urinal fixing
WD

Item	Item No.	Contents per plastic bag	Sales unit
		[pcs]	[pcs]
WD 8 x 90	080659	2 wall plugs UX 10 x 60, 2 stud screws M8 x 90 zinc-plated, 2 flanged nuts BU M8	50
WD 8 x 110	080658	2 wall plugs UX 10 x 60, 2 stud screws M8 x 110 zinc-plated, 2 flanged nuts BU M8	50
WD 10 x 120	080655	2 wall plugs UX 14 x 75, 2 stud screws M10 x 120 zinc-plated, 2 flanged nuts BU M10 MH	50
WD 10 x 140	080656	2 wall plugs UX 14 x 75, 2 stud screws M10 x 140 zinc-plated, 2 flanged nuts BU M10 MH	50

Technical data

7



Boiler fixing BO

Item	Item No.	Contents per plastic bag	Sales unit
		[pcs]	[pcs]
BO 120	080654	4 wall plugs UX 14 x 75, 4 stud screws M10 x 120 zinc-plated, 4 flanged nuts BU M10	25

Technical data



Washbasin fixing WST

Item	Item No.	Contents per plastic bag	Sales unit
		[pcs]	[pcs]
WST 10 x 140	080660	2 wall plugs UX 14 x 75, 2 stud screws M10 x 140 zinc-plated, 2 hexagon nuts M10 zinc-plated, 2 flanged bushes BDH M10	50
WST 12 x 150	080661	2 wall plugs UX 14 x 75, 2 stud screws M12 x 150 zinc-plated, 2 hexagon nuts M12 zinc-plated, 2 flanged bushes BDH M12	50
WST 12 x 180	080662	2 wall plugs UX 14 x 75, 2 stud screws M12 x 180 zinc-plated, 2 hexagon nuts M12 zinc-plated, 2 flanged bushes BDH M12	50

Technical data



Urinal fixing UST 8 x 110

Urinal fixing UST 10 x 120

Item	Item No.	Contents per plastic bag	Sales unit
		[pcs]	[pcs]
UST 10 x 120	080668	2 wall plugs UX 14 x 75, 2 stud screws M10 x 120, 2 flanged nuts BU M10, 2 cover caps AKM 10 CR	10
UST 8 x 110	083578	2 wall plugs UX 10 x 60, 2 stud screws M8 x 110, 2 washers B 8.4 DIN 125, 2 plastic washer 8,4 x 16 x 1,6, 2 cap nuts FA 8, 2 cover caps chrome plated	50

Technical data



Sanitary fixing WL

Item	Item No.	Contents per plastic bag	Sales unit
		[pcs]	[pcs]
WL 7 x 60	080651	2 plugs S 10, 2 screws 7 x 65 hex. head zinc-plated, 2 washers zinc-plated	100
WL 8 x 70	080652	2 plugs S 10, 2 screws 8 x 70 hex. DIN 571 zinc-plated, 2 washers zinc-plated	100
WL 10 x 80	080650	2 plugs S 12, 2 screws 10 x 80 hex. DIN 571 zinc-plated, 2 washers zinc-plated	50

Accessories



Flanged nut BUM

Item	Item No.	Thread	Width across nut	Washer	Match	Sales unit
		M	SW [mm]	[mm]		[pcs]
BU M8 MH	060200 ¹⁾	M 8	17	40	STS M8	25
BU M10 MH	060201	M 10	17	40	STS M10	25
BU M12 MH	060204	M 12	19	40	STS M12	25

1) Delivery time on request.

Accessories



Cover cap AKM









Item	Item No.	Colour	Match	Sales unit
				[pcs]
AKM 10 W	080972	white	BU M10 MH	20
AKM 10 CR	080951	chrome	BU M10 MH	100
AKM 12 CR	080952	chrome	BU M12 MH	100







8

Plugs and anchors

HIGH PERFORMANCE STEEL ANCHORS





Bolt anchor FAZ II	405	
ZYKON undercut anchor FZA	410	
ZYKON hammerset anchor FZEA II	411	
Concrete Screw UltraCut FBS II	412	
Hammerset anchor EA II	416	
Nail anchor FNA II	418	
Ceiling nail FDN II	419	
Hollow-ceiling anchor FHY	420	

CHEMICAL FIXINGS











Injection mortar FIS HB	422	
Highbond-Resin Capsule FHB II-P / PF	422	
Highbond anchor FHB II-A S / L	423	
Superbond mortar FIS SB	425	
Injection mortar FIS V	427	

PLASTIC FIXINGS







Frame fixing SXR	431	
Frame fixing SXRL	432	

Stand-off installation TherMax 8/10	433	
Stand-off installation TherMax 12/16	434	
DuoPower	435	
Universal plug UX	436	
Expansion plug SX	437	













FOAMS AND SEALANTS

One-component gun foam	438	
2-component premium rapid foam	438	
One-component fast bonding foam	439	
Premium sanitary silicone DSSA	439	
Premium construction silicone DBSA	440	
Multi Adhesive & Sealant KD	440	
Premium all-weather sealant DDK	441	
Flexible power adhesive premium HTM	441	
Zinc spray FTC-ZS/FTC-ZA	442	
Accessories	442	

Overview of anchors and their approvals or suitability for sprinkler installations.

Overview of anchors and their approvals or suitability for sprinkler installations					
	 		 		
Typ	ETA Concrete single	ETA Concrete multiple	ETA Masonry	VdS approved	FM approved
FAZ II	Option 1	–	–	●	●
UltraCut	Option 1	● (FBS 6)	–	● (incl. FBS 6)	–
FBS II	Option 1	–	–	●	●
FZA	Option 1	–	–	–	–
FHB II	Option 1	–	–	●	●
FZEA II	Option 7	–	–	●	●
EA II	Option 1	●	–	–	–
FIS V/VS/VW Plus	Option 1	–	●	–	–
FIS SB	Option 1	–	–	–	–
FIS V Plus	–	–	●	–	–
FNA II	–	●	–	●	–
FPX-I	–	–	● Aerated concrete	● Aerated concrete	–
FDN II	–	●	–	–	–
SXR/SXRL	–	●	●	–	–

Anchor recommendation for fixing of Installation System products.

Anchor recommendation for fixing of Installation System products			
	Installation System products for push-through	Plugs recommendation for concrete substrate	Plugs recommendation for masonry substrate
CAT. 1	FCA 	FAZ II 	SXRL 
	FUS 	UltraCut FBS II 	FIS V Plus with threaded rod or internal threaded socket as an alternative for pre positional installation. 
	VB 		
CAT. 2	FLS 	UltraCut FBS II 6 	SXRL 
	GPL 	FDN II  FNA II 	As an alternative for pre-positioned installation!















Push-through installation

Drilling of the hole as well as the installation of the anchor takes place through the baseplate of the cantilever arm, the channel or saddle flange, ...

Note: The combination of Installation System products and anchors is variable.

Anchor recommendation for fixing of Installation System products.

Anchor recommendation for fixing of Installation System products

	 Plugs recommendation for concrete substrate	 Plugs recommendation for masonry substrate
Installation System products for push-through G/GS 	EA II 	FPX-I for aerated concrete 
Pipe clamp 	FZEA II 	FIS V Plus with threaded rod or internal threaded socket as an alternative for pre positional installation.   
	UltraCut FBS II 6 	UX 
	FGD 	SX 
		DuoPower 

Pre positioned installation

Drilling and anchor installation is done before installing (if required by screwing in) of the accessory like threaded rod or pipe clamps, ...

For further details as loads and dimensions please see the following pages or www.fischer-international.com

Note: The combination of Installation System products and anchors is variable.

High performance steel anchors

Bolt anchor FAZ II

For highest demands. Powerful and flexible.

Technical data



Bolt anchor FAZ II

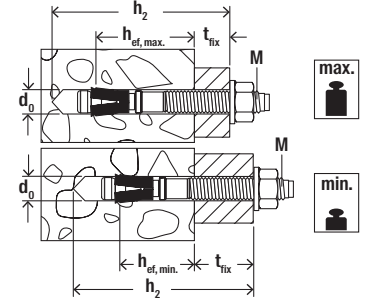

Item	Zinc-plated steel	Stainless steel	Highly corrosion resistant steel	Approval		Seismic-Approval	Drill hole diameter d_0 [mm]	Min. drill hole depth for through fixings h_2 [mm]	Max. usable length hef,max./ hef,min. t_{fix} [mm]	Anchor length l [mm]	Thread \emptyset x length [mm]	Width across nut SW [mm]	Sales unit [pcs]
	Item No. gvz	Item No. R	Item No. HCR	ETA	ICC								
FAZ II 6/10	542621	542623	—	●	—	—	6	60	10/-	65	M 6 x 25	10	50
FAZ II 6/20	542622	542624	—	●	—	—	6	70	20/-	75	M 6 x 35	10	50
FAZ II 8/10	094871 ¹⁾	501396 ¹⁾	—	●	●	C1	8	65	10/20	75	M 8 x 38	13	50
FAZ II 8/10	—	—	501428 ¹⁾	●	●	C1	8	65	10/20	75	M 8 x 38	13	10
FAZ II 8/30	094877 ¹⁾	501399 ¹⁾	—	●	●	C1	8	85	30/40	95	M 8 x 58	13	50
FAZ II 8/30	—	—	501429 ¹⁾	●	●	C1	8	85	30/40	95	M 8 x 58	13	10
FAZ II 8/50	094878 ¹⁾	501401	—	●	●	C1	8	105	50/60	115	M 8 x 78	13	50
FAZ II 8/100	094879 ¹⁾	—	—	●	●	C1	8	155	100/110	165	M 8 x 128	13	25
FAZ II 8/160	503251 ¹⁾	—	—	●	●	C1	8	215	160/170	225	M 8 x 100	13	20
FAZ II 10/10	094981	501403	—	●	●	C1 / C2	10	85	10/30	95	M 10 x 53	17	50
FAZ II 10/10	—	—	501430	●	●	C1	10	85	10/30	95	M 10 x 53	17	10
FAZ II 10/20	094982	—	—	●	●	C1 / C2	10	95	20/40	105	M 10 x 63	17	25
FAZ II 10/20	—	501406	—	●	●	C1 / C2	10	95	20/40	105	M 10 x 63	17	50
FAZ II 10/30	094983	—	—	●	●	C1 / C2	10	105	30/50	115	M 10 x 73	17	25
FAZ II 10/30	—	501407	—	●	●	C1 / C2	10	105	30/50	115	M 10 x 73	17	50
FAZ II 10/30	—	—	503185	●	●	C1	10	105	30/50	115	M 10 x 73	17	10
FAZ II 10/50	094984	501409	—	●	●	C1 / C2	10	125	50/70	135	M 10 x 93	17	20
FAZ II 10/70	—	501410	—	●	●	C1 / C2	10	145	70/90	155	M 10 x 113	17	20
FAZ II 10/80	094985	—	—	●	●	C1 / C2	10	155	80/100	165	M 10 x 123	17	20
FAZ II 10/100	—	501411	—	●	●	C1 / C2	10	175	100/120	185	M 10 x 100	17	20
FAZ II 10/100	094986	—	—	●	●	C1 / C2	10	175	100/120	185	M 10 x 143	17	20
FAZ II 10/160	—	501412	—	●	●	—	10	235	160/180	245	M 10 x 100	17	20
FAZ II 10/160	503252	—	—	●	●	—	10	235	160/180	245	M 10 x 193	17	20
FAZ II 12/10	095419	501413	—	●	●	C1 / C2	12	100	10/30	110	M 12 x 61	19	20
FAZ II 12/10	—	—	503186	●	●	C1	12	100	10/30	110	M 12 x 61	19	10
FAZ II 12/20	095420	501415	—	●	●	C1 / C2	12	110	20/40	120	M 12 x 71	19	20
FAZ II 12/30	095421	501416	—	●	●	C1 / C2	12	120	30/50	130	M 12 x 81	19	20
FAZ II 12/30	—	—	501431	●	●	C1	12	120	30/50	130	M 12 x 81	19	10
FAZ II 12/50	095446	501419	—	●	●	C1 / C2	12	140	50/70	150	M 12 x 101	19	20
FAZ II 12/60	—	501420	—	●	●	C1 / C2	12	150	60/80	160	M 12 x 111	19	20
FAZ II 12/80	095454	—	—	●	●	C1 / C2	12	170	80/100	180	M 12 x 131	19	20
FAZ II 12/100	095470	501421	—	●	●	C1 / C2	12	190	100/120	200	M 12 x 151	19	20
FAZ II 12/160	503253	—	—	●	●	—	12	250	160/180	260	M 12 x 186	19	10
FAZ II 12/160	—	503180	—	●	●	—	12	250	160/180	260	M 12 x 100	19	20
FAZ II 12/200	095605	—	—	●	●	—	12	290	200/220	300	M 12 x 186	19	10
FAZ II 16/5	522124	—	—	●	●	C1 / C2	16	115	5/25	128	M 16 x 64	24	10

1) With minimum embedment depth only for statically indeterminate systems

Technical data



Bolt anchor FAZ II

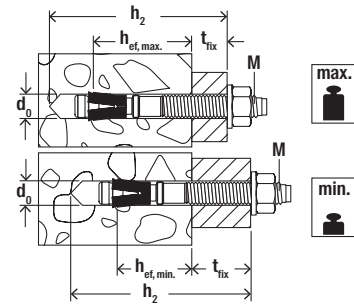

Item	Zinc-plated steel	Stainless steel	Highly corrosion resistant steel	Approval		Seismic-Approval	Drill hole diameter	Min. drill hole depth for through fixings	Max. usable length hef,max./ hef,min.	Anchor length	Thread	Width across nut	Sales unit
	Item No. gvz	Item No. R	Item No. HCR	ETA	ICC		d ₀ [mm]	h ₂ [mm]	t _{fix} [mm]	l [mm]	Ø x length [mm]	SW [mm]	[pcs]
FAZ II 16/5	—	522125	—	●	●	C1 / C2	16	115	5/25	128	M 16 x 64	24	20
FAZ II 16/25	—	501423	—	●	●	C1 / C2	16	135	25/45	148	M 16 x 84	24	20
FAZ II 16/25	—	—	501432	●	●	C1	16	135	25/45	148	M 16 x 84	24	10
FAZ II 16/25	095836	—	—	●	●	C1 / C2	16	135	25/45	148	M 16 x 84	24	10
FAZ II 16/50	095864	—	—	●	●	C1 / C2	16	160	50/70	173	M 16 x 109	24	10
FAZ II 16/50	—	—	503187	●	●	C1	16	160	50/70	173	M 16 x 109	24	10
FAZ II 16/50	—	501424	—	●	●	C1 / C2	16	160	50/70	173	M 16 x 109	24	20
FAZ II 16/100	095865	501425	—	●	●	C1 / C2	16	210	100/120	223	M 16 x 159	24	10
FAZ II 16/160	503254	—	—	●	●	C1 / C2	16	270	160/180	283	M 16 x 189	24	10
FAZ II 16/200	095967	—	—	●	●	—	16	310	200/220	323	M 16 x 189	24	10
FAZ II 16/250	095968	—	—	●	●	—	16	360	250/270	373	M 16 x 100	24	10
FAZ II 16/300	096188	—	—	●	●	—	16	410	300/320	423	M 16 x 100	24	10
FAZ II 20/30	046632	—	—	●	●	C1 / C2	20	155	30/-	172	M 20 x 54	30	5
FAZ II 20/30	—	501426	—	●	●	C1 / C2	20	155	30/-	172	M 20 x 54	30	4
FAZ II 20/60	046633	—	—	●	●	C1 / C2	20	185	60/-	202	M 20 x 84	30	5
FAZ II 20/60	—	503183	—	●	●	C1 / C2	20	185	60/-	202	M 20 x 84	30	4
FAZ II 20/160	503255	—	—	●	●	C1 / C2	20	285	160/-	302	M 20 x 100	30	5
FAZ II 24/30	046635	—	—	●	●	C1	24	185	30/-	205	M 24 x 58	36	5
FAZ II 24/30	—	501427	—	●	●	C1	24	185	30/-	205	M 24 x 58	36	4
FAZ II 24/60	046636	—	—	●	●	C1	24	215	60/-	235	M 24 x 88	36	5
FAZ II 24/60	—	503184	—	●	●	C1	24	215	60/-	235	M 24 x 88	36	4

1) With minimum embedment depth only for statically indeterminate systems

8

High performance steel anchors

Bolt anchor FAZ II H

For highest demands. Offers a visually attractive anchoring.

Technical data



Bolt anchor FAZ II H

Cap nut FAZ II

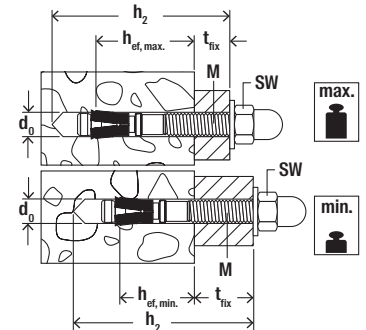

Item	Zinc-plated steel	Stainless steel	Approval	Seis-mic-Approval	Drill hole diameter d_0 [mm]	Min. drill hole depth for through fixings h_2 [mm]	Anchor length l [mm]	Max. usable length $h_{ef,max.}/h_{ef,min.}$ t_{fix} [mm]	Thread $\emptyset \times$ length [mm]	Width across nut	Sales unit
	Item No. gvz	Item No. R								ETA	
FAZ II 10/10 H	543392	543396	●	C1 / C2	10	87	95	10/30	M 10 x 53	17	20
FAZ II 10/20 H	543393	543397	●	C1 / C2	10	97	105	20/40	M 10 x 63	17	20
FAZ II 12/10 H	543394	543398	●	C1 / C2	12	99	109	10/30	M 12 x 61	19	20
FAZ II 12/20 H	543395	543399	●	C1 / C2	12	109	119	20/40	M 12 x 71	19	20
Cap nut FAZ II M10	543977 ¹⁾	543979 ¹⁾	●	—	—	—	—	—	M 10	17	20
Cap nut FAZ II M12	543978 ¹⁾	543980 ¹⁾	●	—	—	—	—	—	M 12	19	20

1) Can be combined with all bolt anchors FAZ II M10 and M12 in accordance with approval.
Approval Seismic C1/C2 only with maximum embedment depth

High performance steel anchors

Bolt anchor FAZ II K

For highest demands. Short and practible.

Technical data



Bolt anchor FAZ II K

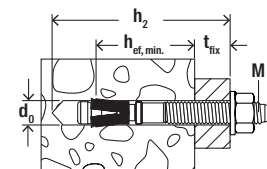

Item	Zinc-plated steel	Stainless steel	Approval	Drill hole diameter d_0 [mm]	Min. drill hole depth for through fixings h_2 [mm]	Anchor length l [mm]	Usable length (hef min.) t_{fix} [mm]	Thread $\emptyset \times$ length [mm]	Washer (outer diameter x thickness) [mm]	Sales unit [pcs]
	Item No. gvz	Item No. R								
FAZ II 8/5 K	538989	538990	●	8	45	60	5	M 8 x 23	16 x 1,6	50
FAZ II 10/10 K	522108	522116	●	10	65	75	10	M 10 x 33	20 x 2	50
FAZ II 10/20 K	522110	—	●	10	75	85	20	M 10 x 43	20 x 2	25
FAZ II 10/20 K	—	522117	●	10	75	85	20	M 10 x 43	20 x 2	50

Technical data



Bolt anchor FAZ II K

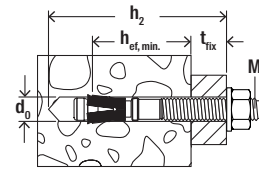

Item	Zinc-plated steel	Stainless steel	Approval	Drill hole diameter	Min. drill hole depth for through fixings	Anchor length	Usable length (hef min.)	Thread	Washer (outer diameter x thickness)	Sales unit
	Item No. gvz	Item No. R		d_0 [mm]	h_2 [mm]		l [mm]		t_{fix} [mm]	
FAZ II 12/10 K	522118	522122	●	12	80	90	10	M 12 x 41	24 x 2,5	20
FAZ II 12/20 K	522119	522123	●	12	90	100	20	M 12 x 51	24 x 2,5	20
FAZ II 10/10 K GS	522115	—	●	10	65	75	10	M 10 x 33	25 x 3	50
FAZ II 12/10 K GS	522121	—	●	12	80	90	10	M 12 x 41	30 x 3	20

High performance steel anchors

Bolt anchor FAZ II GS / HBS

For highest demands. Powerful and flexible.

Technical data

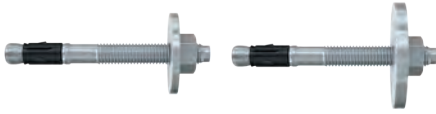

Bolt anchor FAZ II GS (with large washer)

Bolt anchor FAZ II HBS (washer compliant to wood construction standard DIN 1052)

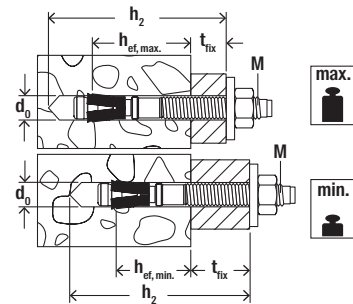

Item	Steel, zinc-plated, with large washer	Stainless steel, with large washer	Approval	Seis-mic-Ap-approval	Drill hole diameter	Min. drill hole depth for through fixings	Anchor length	Max. usable length hef,max./ hef,min.	Thread	Width across nut	Washer (outer diameter x thickness)	Sales unit
	Item No. gvz	Item No. R		ETA		d_0 [mm]		h_2 [mm]		l [mm]	t_{fix} [mm]	
FAZ II 8/10 GS	094872	501398	●	C1	8	65	75	10/20	M 8 x 38	13	22 x 2,5	50
FAZ II 8/30 GS	096189	501400	●	C1	8	85	95	30/40	M 8 x 58	13	22 x 2,5	50
FAZ II 10/10 GS	096291	501405	●	C1 / C2	10	85	95	10/30	M 10 x 53	17	25 x 3	50
FAZ II 10/30 GS	096297	—	●	C1 / C2	10	105	115	30/50	M 10 x 73	17	25 x 3	25
FAZ II 10/30 GS	—	501408	●	C1 / C2	10	105	115	30/50	M 10 x 73	17	25 x 3	50
FAZ II 12/10 GS	096303	501414	●	C1 / C2	12	100	110	10/30	M 12 x 61	19	30 x 3	20
FAZ II 12/20 GS	502530	—	●	C1 / C2	12	110	120	20/40	M 12 x 71	19	30 x 3	20
FAZ II 12/30 GS	096340	501418	●	C1 / C2	12	120	130	30/50	M 12 x 81	19	30 x 3	20
FAZ II 12/50 GS	502531	—	●	C1 / C2	12	140	150	50/70	M 12 x 101	19	30 x 3	20
FAZ II 12/80 GS	538430	—	●	C1 / C2	12	170	180	80/100	M 12 x 131	19	44 x 4	20
FAZ II 12/100 GS	502532	—	●	C1 / C2	12	190	200	100/120	M 12 x 151	19	30 x 3	20
FAZ II 12/100 GS	538702	—	●	C1 / C2	12	190	200	100/120	M 12 x 151	19	44 x 4	20
FAZ II 12/120 GS	096367	—	●	C1 / C2	12	210	220	120/140	M 12 x 171	19	30 x 3	20
FAZ II 12/120 GS	538703	—	●	C1 / C2	12	210	220	120/140	M 12 x 171	19	44 x 4	20
FAZ II 12/140 GS	538433	—	●	C1 / C2	12	230	240	140/160	M 12 x 186	19	44 x 4	20
FAZ II 12/160 GS	538431	—	●	C1 / C2	12	250	260	160/180	M 12 x 186	19	44 x 4	20
FAZ II 12/160 GS	—	503181	●	—	12	250	260	160/180	M 12 x 186	19	44 x 4	20

Technical data

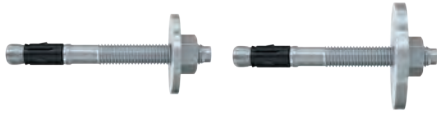

Bolt anchor FAZ II GS (with large washer)

Bolt anchor FAZ II HBS (washer compliant to wood construction standard DIN 1052)

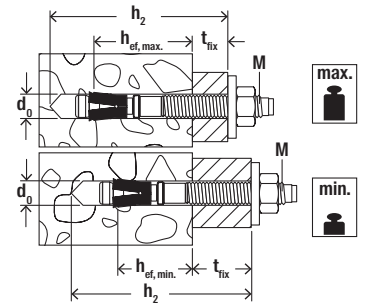

Item	Steel, zinc-plated, with large washer	Stainless steel, with large washer	Approval ETA	Seismic-Approval C1 / C2	Drill hole diameter	Min. drill hole depth for through fixings	Anchor length	Max. usable length hef,max./ hef,min.	Thread	Width across nut	Washer (outer diameter x thickness)	Sales unit
	Item No. gvz	Item No. R			d0 [mm]	h2 [mm]	l [mm]	tfix [mm]	Ø x length [mm]	SW [mm]	[mm]	[mm]
FAZ II 12/180 GS	538434	—	●	C1 / C2	12	270	280	180/200	M 12 x 186	19	44 x 4	20
FAZ II 12/200 GS	538432	—	●	C1 / C2	12	290	300	200/220	M 12 x 186	19	44 x 4	20
FAZ II 16/160 GS	503261	—	●	C1 / C2	16	270	283	160/180	M 16 x 189	24	56 x 5	10
FAZ II 16/160 GS	—	503182	●	C1 / C2	16	270	283	160/180	M 16 x 100	24	56 x 5	4
FAZ II 16/200 GS	096370	—	●	—	16	310	323	200/220	M 16 x 189	24	56 x 5	10
FAZ II 12/100 HBS	522951	—	●	C1 / C2	12	190	205	100/120	M 12 x 151	19	58 x 6	20
FAZ II 12/120 HBS	522952	—	●	C1 / C2	12	210	225	120/140	M 12 x 171	19	58 x 6	20
FAZ II 16/160 HBS	522953	—	●	C1 / C2	16	270	278	160/180	M 16 x 189	24	68 x 6	10
FAZ II 16/200 HBS	522954	—	●	—	16	310	328	200/220	M 16 x 189	24	68 x 6	10

Accessories



Bolt anchor setting tool FABS

Bolt anchor setting tool FA-ST

Item	Item No.	Matching anchor type	Sales unit
			[pcs]
FABS	077937	FAZ II, FBZ, FBN II for diameter from M6 - M12	1
FA-ST M10	541891	FAZ II M10, FBZ M10, FBN II M10, EXA M10	1
FA-ST M12	541892	FAZ II M12, FBZ M12, FBN II M12, EXA M12	1

High performance steel anchors

ZYKON undercut anchor FZA

The fixing system with the highest safety in cracked concrete

Technical data



ZYKON Bolt anchor FZA

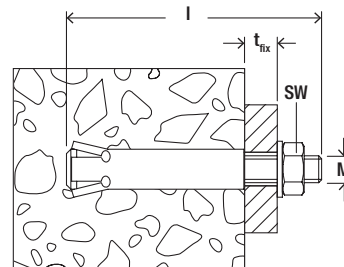

Item	Zinc-plated steel	Stainless steel	Approval ETA	Seis- mic- Ap- proval	Required drill bit FZUB	Required setting tool FZE plus	Bolt length	Max. fixture thickness	Thread	Width across nut	Sales unit
	Item No. gvz	Item No. R					l [mm]	t _{fix} [mm]	M	SW [mm]	[pcs]
FZA 10 x 40 M6/10	060712	060772	●	—	10 x 40	FZE 10 plus	60	10	M 6	10	25
FZA 12 x 40 M 8/15	060715	060775	●	—	12 x 40	FZE 12 plus	69	15	M 8	13	25
FZA 12 x 50 M 8/15	060716	060776	●	—	12 x 50	FZE 12 plus	79	15	M 8	13	20
FZA 12 x 50 M 8/50	—	060774	●	—	12 x 50	FZE 12 plus	114	50	M 8	13	20
FZA 14 x 40 M10/25	060718	—	●	C2	14 x 40	FZE 14 plus	79	25	M 10	17	25
FZA 14 x 40 M10/25	—	060778	●	C2	14 x 40	FZE 14 plus	79	25	M 10	17	20
FZA 14 x 60 M10/25	060719	060779	●	C2	14 x 60	FZE 14 plus	102	25	M 10	17	10
FZA 14 x 60 M10/50	—	060766	●	C2	14 x 60	FZE 14 plus	126	50	M 10	17	10
FZA 18 x 80 M12/25	060721	060781	●	C2	18 x 80	FZE 18 plus	126	25	M 12	19	10
FZA 18 x 80 M12/55	—	060767	●	C2	18 x 80	FZE 18 plus	156	55	M 12	19	10
FZA 22 x 100 M16/60	060724	060782	●	C2	22 x 100	FZE 22 plus	184	60	M 16	24	10
FZA 22 x 125 M16/60	060725	060768	●	C2	22 x 125	FZE 22 plus	209	60	M 16	24	6

8

Technical data



ZYKON Through anchor FZA-D

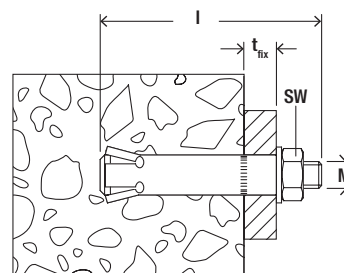

Item	Zinc-plated steel	Stainless steel	Approval ETA	Seis- mic- Ap- proval	Required drill bit FZUB	Required setting tool FZE plus	Bolt length	Max. fixture thickness	Thread	Width across nut	Sales unit
	Item No. gvz	Item No. R					l [mm]	t _{fix} [mm]	M	SW [mm]	[pcs]
FZA 12 x 50 M 8 D/10	060652	060664	●	—	12 x 50	FZE 12 plus	69	10	M 8	13	25
FZA 12 x 60 M 8 D/10	060653	060665	●	—	12 x 60	FZE 12 plus	79	10	M 8	13	25
FZA 12 x 80 M 8 D/30	060654	060666	●	—	12 x 80	FZE 12 plus	99	30	M 8	13	25
FZA 14 x 80 M10 D/20	060657	060669	●	C2	14 x 80	FZE 14 plus	102	20	M 10	17	10
FZA 14 x 100 M 8 D/30	—	060670	●	C2	14 x 100	FZE 14 plus	126	30	M 10	17	10
FZA 14 x 100 M 8 D/30	060658	—	●	C2	14 x 100	FZE 14 plus	126	40	M 10	17	10
FZA 18 x 100 M12 D/20	060684	060672	●	C2	18 x 100	FZE 18 plus	126	20	M 12	19	10
FZA 18 x 130 M12 D/50	060685	060673	●	C2	18 x 130	FZE 18 plus	156	50	M 12	19	10
FZA 22 x 125 M16 D/25	060663	060675	●	C2	22 x 125	FZE 22 plus	156	25	M 16	24	10

Technical data



ZYKON Internally-threaded anchor FZA-I

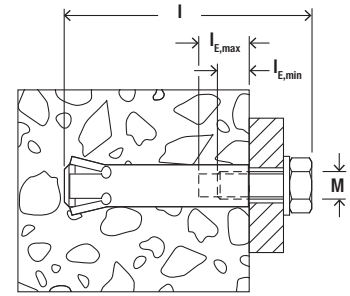

Item	Zinc-plated steel	Stainless steel	Approval	Required drill bit FZUB	Required setting tool FZE plus	Internal thread	Min. bolt penetration	Max. bolt penetration	Sales unit [pcs]
	Item No. gvz	Item No. R	ETA				$l_{E,min}$ [mm]	$l_{E,max}$ [mm]	
FZA 12 x 40 M6 I	060758	060783	●	12 x 40	FZE 12 plus	M 6	10	15	25
FZA 12 x 50 M6 I	—	060784	●	12 x 50	FZE 12 plus	M 6	10	15	25
FZA 14 x 60 M8 I	060760	060786	●	14 x 60	FZE 14 plus	M 8	11	17	20
FZA 18 x 80 M10 I	060761	060787	●	18 x 80	FZE 18 plus	M 10	13	21	10
FZA 22 x 100 M12 I	060763	060788	●	22 x 100	FZE 22 plus	M 12	15	25	10
FZA 22 x 125 M12 I	060769	060770 ¹⁾	●	22 x 125	FZE 22 plus	M 12	15	25	10

1) Delivery time on request.

High performance steel anchors

ZYKON hammerset anchor FZEA II

The internally threaded anchor with low anchoring depth for individual fixings in cracked concrete

Technical data



Zykon-Hammerset anchor FZEA II

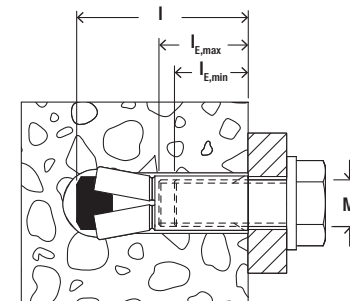

Item	Zinc-plated steel	Stainless steel	Highly corrosion resistant steel	Approval	Required drill bit FZUB	Required setting tool FZED plus	Length L [mm]	Internal thread	Max. bolt penetration	Min. bolt penetration	Sales unit [pcs]
	Item No. gvz	Item No. R	Item No. HCR	ETA					$l_{E,max}$ [mm]	$l_{E,min}$ [mm]	
FZEA II 10 x 40 M 8	047303	047306	047309 ¹⁾	●	10 x 40	FZED 10 plus	43	M 8	17	11	100
FZEA II 12 x 40 M10	047304	047307	047310 ¹⁾	●	12 x 40	FZED 12 plus	43	M 10	19	13	100
FZEA II 14 x 40 M12	047305	047308	—	●	14 x 40	FZED 14 plus	43	M 12	21	15	50

1) Delivery on request.

High performance steel anchors

Concrete screw ULTRACUT FBS II

The high-performance concrete screw for absolute installation ease

Technical data



UltraCut FBS II US - hexagon head with integral washer

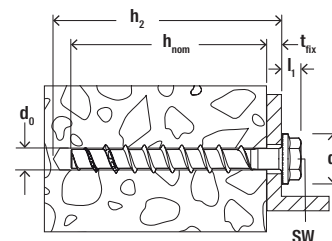

Item	Item No.	Approval ETA	Drill hole diameter d_0 [mm]	Min. drill hole depth for through fixings h_2 [mm]	Screw $d_a \times l_s$ [mm]	Screw-in depth with fixture thickness h_{nom1} / t_{fix} [mm]	Screw-in depth with fixture thickness h_{nom2} / t_{fix} [mm]	Screw-in depth with fixture thickness h_{nom3} / t_{fix} [mm]	Drive	Sales unit [pcs]
FBS II 8x55 5/- US TX	536851	●	8	65	10 x 55	50 / 5	- / -	- / -	TX40/SW13	50
FBS II 8x70 20/5 US TX	536852	●	8	80	10 x 70	50 / 20	65 / 5	65 / 5	TX40/SW13	50
FBS II 8x80 30/15 US TX	536853	●	8	90	10 x 80	50 / 30	65 / 15	65 / 15	TX40/SW13	50
FBS II 8x90 40/25 US TX	536854	●	8	100	10 x 90	50 / 40	65 / 25	65 / 25	TX40/SW13	50
FBS II 8x100 50/35 US TX	536855	●	8	110	10 x 100	50 / 50	65 / 35	65 / 35	TX40/SW13	50
FBS II 8x110 60/45 US TX	536856	●	8	120	10 x 110	50 / 60	65 / 45	65 / 45	TX40/SW13	50
FBS II 8x130 80/65 US TX	536857	●	8	140	10 x 130	50 / 80	65 / 65	65 / 65	TX40/SW13	50
FBS II 10x60 5/-/- US	536858	●	10	70	12 x 60	55 / 5	- / -	- / -	SW 15	50
FBS II 10x70 15/5/- US	536859	●	10	80	12 x 70	55 / 15	65 / 5	- / -	SW 15	50
FBS II 10x80 25/15/- US	536860	●	10	90	12 x 80	55 / 25	65 / 15	- / -	SW 15	50
FBS II 10x90 35/25/5 US	536861	●	10	100	12 x 90	55 / 35	65 / 25	85 / 5	SW 15	50
FBS II 10x100 45/35/15 US	536862	●	10	110	12 x 100	55 / 45	65 / 35	85 / 15	SW 15	50
FBS II 10x120 65/55/35 US	536863	●	10	130	12 x 120	55 / 65	65 / 55	85 / 35	SW 15	50
FBS II 10x140 85/75/55 US	536864	●	10	150	12 x 140	55 / 85	65 / 75	85 / 55	SW 15	50
FBS II 10x160 105/95/75 US	536865	●	10	170	12 x 160	55 / 105	65 / 95	85 / 75	SW 15	50
FBS II 10x200 145/135/115 US	536866	●	10	210	12 x 200	55 / 145	65 / 135	85 / 115	SW 15	20
FBS II 10x230 175/165/145 US	536867	●	10	240	12 x 230	55 / 175	65 / 165	85 / 145	SW 15	20
FBS II 10x260 205/195/175 US	536868	●	10	270	12 x 260	55 / 205	65 / 195	85 / 175	SW 15	20
FBS II 12x70 10/-/- US	536869	●	12	80	14 x 70	60 / 10	- / -	- / -	SW 17	20
FBS II 12x85 25/10/- US	536870	●	12	95	14 x 85	60 / 25	75 / 10	- / -	SW 17	20
FBS II 12x110 50/35/10 US	536871	●	12	120	14 x 110	60 / 50	75 / 35	100 / 10	SW 17	20
FBS II 12x130 70/55/30 US	536872	●	12	140	14 x 130	60 / 70	75 / 55	100 / 30	SW 17	20
FBS II 12x150 90/75/50 US	536873	●	12	160	14 x 150	60 / 90	75 / 75	100 / 50	SW 17	20
FBS II 14x75 10/-/- US	536874	●	14	90	16 x 75	65 / 10	- / -	- / -	SW 21	20
FBS II 14x95 30/10/- US	536875	●	14	110	16 x 95	65 / 30	85 / 10	- / -	SW 21	20
FBS II 14x100 35/15/- US	536876	●	14	115	16 x 100	65 / 35	85 / 15	- / -	SW 21	20
FBS II 14x125 60/40/10 US	536877	●	14	140	16 x 125	65 / 60	85 / 40	115 / 10	SW 21	10
FBS II 14x150 85/65/35 US	536878	●	14	165	16 x 150	65 / 85	85 / 65	115 / 35	SW 21	10

Technical data



UltraCut FBS II SK - counter-sunk head

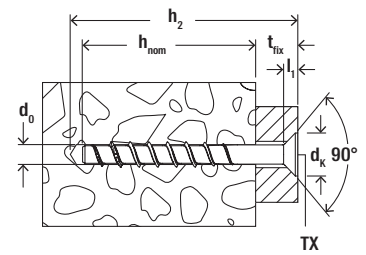

Item	Item No.	Approval ETA	Drill hole diameter	Min. drill hole depth for through fixings	Screw	Screw-in depth with fixture thickness	Screw-in depth with fixture thickness	Screw-in depth with fixture thickness	Drive	Sales unit [pcs]
			d_0 [mm]	h_2 [mm]	$d_a \times l_s$ [mm]	h_{nom1} / t_{fix} [mm]	h_{nom2} / t_{fix} [mm]	h_{nom3} / t_{fix} [mm]		
FBS II 8x60 10/- SK	536880	●	8	70	10 x 60	50 / 10	- / -	- / -	TX40	50
FBS II 8x80 30/15 SK	536881	●	8	90	10 x 80	50 / 30	65 / 15	65 / 15	TX40	50
FBS II 8x90 40/25 SK	536882	●	8	100	10 x 90	50 / 40	65 / 25	65 / 25	TX40	50
FBS II 10x65 10/- SK	536884	●	10	75	12 x 65	55 / 10	- / -	- / -	TX50	50
FBS II 10x80 25/15/- SK	536885	●	10	90	12 x 80	55 / 25	65 / 15	- / -	TX50	50
FBS II 10x95 40/30/10 SK	536886	●	10	105	12 x 95	55 / 40	65 / 30	85 / 10	TX50	50
FBS II 10x100 45/35/15 SK	536887	●	10	110	12 x 100	55 / 45	65 / 35	85 / 15	TX50	50
FBS II 10x120 65/55/35 SK	536888	●	10	130	12 x 120	55 / 65	65 / 55	85 / 35	TX50	50

Technical data



UltraCut FBS II US R - hexagon head with molded washer, stainless steel R

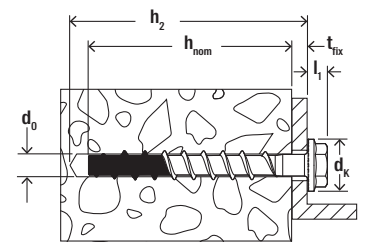

Item	Item No.	Approval ETA	Drill hole diameter	Min. drill hole depth for through fixings	Screw-in depth with fixture thickness	Screw-in depth with fixture thickness	Screw-in depth with fixture thickness	Drive	Sales unit [pcs]
			d_0 [mm]	h_2 [mm]	h_{nom1} / t_{fix} [mm]	h_{nom2} / t_{fix} [mm]	h_{nom3} / t_{fix} [mm]		
FBS II 8x60 10/- US R	543565	●	8	70	50 / 10	- / -	- / -	SW 13	50
FBS II 8x70 20/5 US R	543566	●	8	80	50 / 20	- / -	65 / 5	SW 13	50
FBS II 8x80 30/15 US R	543567	●	8	90	50 / 30	- / -	65 / 15	SW 13	50
FBS II 8x90 40/25 US R	543568	●	8	100	50 / 40	- / -	65 / 25	SW 13	50
FBS II 10x60 5/- US R	543569	●	10	70	55 / 5	- / -	- / -	SW 15	50
FBS II 10x70 15/5/- US R	543570	●	10	80	55 / 15	- / -	65 / 5	SW 15	50
FBS II 10x80 25/15/- US R	543571	●	10	90	55 / 25	- / -	65 / 15	SW 15	50
FBS II 10x90 35/25/5 US R	543572	●	10	100	55 / 35	65 / 25	85 / 5	SW 15	50
FBS II 10x100 45/35/15 US R	543573	●	10	110	55 / 45	65 / 35	85 / 15	SW 15	50
FBS II 10x120 65/55/35 US R	543574	●	10	130	55 / 65	65 / 55	85 / 35	SW 15	50
FBS II 12x70 10/- US R	543575	●	12	80	60 / 10	- / -	- / -	SW 17	20
FBS II 12x85 25/10/- US R	543576	●	12	95	60 / 25	- / -	75 / 10	SW 17	20
FBS II 12x110 50/35/10 US R	543577	●	12	120	60 / 50	75 / 35	100 / 10	SW 17	20
FBS II 12x130 70/55/30 US R	543578	●	12	140	60 / 70	75 / 55	100 / 30	SW 17	20

Technical data



UltraCut FBS II SK R - countersunk head, stainless steel R

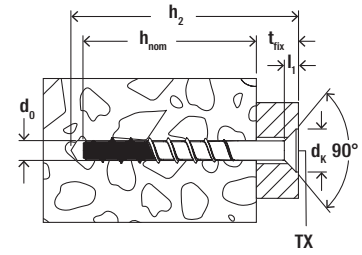

Item	Item No.	Approval ETA	Drill hole diameter	Min. drill hole depth for through fixings	Screw-in depth with fixture thickness	Screw-in depth with fixture thickness	Screw-in depth with fixture thickness	Drive	Sales unit [pcs]
			d_0 [mm]	h_2 [mm]	h_{nom1} / t_{fix} [mm]	h_{nom2} / t_{fix} [mm]	h_{nom3} / t_{fix} [mm]		
FBS II 8x60 10/- SK R	543579	●	8	70	50 / 10	- / -	- / -	TX40	50
FBS II 8x80 30/15 SK R	543580	●	8	90	50 / 30	- / -	65 / 15	TX40	50
FBS II 8x90 40/25 SK R	543581	●	8	100	50 / 40	- / -	65 / 25	TX40	50
FBS II 10x65 10/-/- SK R	543582	●	10	75	55 / 10	- / -	- / -	TX50	50
FBS II 10x80 25/15/- SK R	543583	●	10	90	55 / 25	- / -	65 / 15	TX50	50
FBS II 10x95 40/30/10 SK R	543584	●	10	105	55 / 40	65 / 30	85 / 10	TX50	50
FBS II 10x100 45/35/15 SK R	543585	●	10	110	55 / 45	65 / 35	85 / 15	TX50	50
FBS II 10x120 65/55/35 SK R	543586	●	10	130	55 / 65	65 / 55	85 / 35	TX50	50

Accessories



Checking gauge FUP



Nut SW



Nut 1/2" - TX 50



FMB T40 MaxxBit



FPB Profi-Bit T50 5/16" W 10



Setting tool SC-ST

Item	Item No.	Internal diameter D [mm]	Drive	Match	Sales unit [pcs]
FUP 8	537200	9,9	—	FBS II 8	1
FUP 10	537201	12,0	—	FBS II 10	1
FUP 12	537202	13,0	—	FBS II 12	1
FUP 14	537203	15,0	—	FBS II 14	1
SW10	538577	—	—	FBS II 6	1
Nut SW 13	538578	—	1/2" / SW13	FBS II 8	1
Nut SW 15	538579	—	1/2" / SW15	FBS II 10	1
Nut SW 17	538580	—	1/2" / SW17	FBS II 12	1
Nut SW 21	538581	—	1/2" / SW21	FBS II 14	1
Nut 1/2" - 1/4"	553928	—	1/2" / SW21	FBS II 8 / FBS II 8 SK	1
Nut 1/2" - TX 50	553929	—	—	FBS II 10 / FBS II 10 SK	1
FMB T30 MaxxBit W 5	533158	—	TX30	FBS II 6	1
FMB T40 MaxxBit W 5	533159	—	TX40	FBS II 8 / FBS II 8 SK	5
FPB T 50 5/16" Profi Bit W 10	557844	—	TX50	FBS II 10 SK	1
Setting tool SC-ST 8	557872	—	—	FBS II 8	1
Setting tool SC-ST 10	557874	—	—	FBS II 10	1

Accessories



Filling washer FFD



Washer U

Item	Item No.	Internal diameter D [mm]	External-Ø d [mm]	Match	Sales unit [pcs]
FFD 22 x 9 x 6	547515	9,0	22	FBS II 6	4
FFD 26 x 12 x 6	538458	12,0	26	FBS II 8 / FAZ II 8 / FAZ II 10	4
FFD 30 x 14 x 6	538459	14,0	30	FBS II 10 / FBS II 12 / FAZ II M12	4
FFD 38 x 19 x 7	538460	19	38	FBS II 14 / FAZ II 16	4
FFD 30x14x6 A4	541987	14,0	30	FBS II 10 R / FBS II 12 R / FAZ II M12 R	4
Washer for FBS 10	520471	13,5	44	FBS II 10	50

Technical data



UltraCut FBS II 6 P
- panhead



UltraCut FBS II 6 SK
- countersunk head



UltraCut FBS II 6 US
- hexagonal head with
molded washer

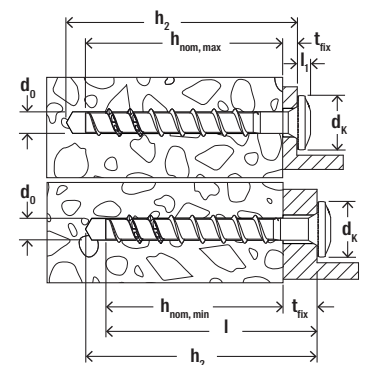

Item	Item No.	Approval ETA	Drill hole diameter	Min. drill hole depth for through fixings	Screw length	Head-Ø	Screw-in depth	Usable length	Drive	Sales unit [pcs]
			d ₀ [mm]	h ₂ [mm]	l _s [mm]	d _K [mm]	h _{nom,min} - h _{nom,max} [mm]	t _{fix,min} - t _{fix,max} [mm]		
FBS II 6 x 30/5 P	546377	●	6	40	30	14.4	25	Screw length - h _{nom}	T30	100
FBS II 6 x 40/5 P	546378	●	6	50	40	14.4	25 - 35	Screw length - h _{nom}	T30	100
FBS II 6 x 40/5 LP	546379	●	6	50	40	17.5	25 - 35	Screw length - h _{nom}	T30	100
FBS II 6 x 60/5 P	546380	●	6	70	60	14.4	25 - 55	Screw length - h _{nom}	T30	100
FBS II 6 x 80/25 P	546381	●	6	90	80	14.4	25 - 55	Screw length - h _{nom}	T30	100
FBS II 6 x 30/5 SK	546382	●	6	40	30	13.5	25	Screw length - h _{nom}	T30	100
FBS II 6 x 40/5 SK	546383	●	6	50	40	13.5	25 - 35	Screw length - h _{nom}	T30	100
FBS II 6 x 60/5 SK	546384	●	6	70	60	13.5	25 - 55	Screw length - h _{nom}	T30	100
FBS II 6 x 80/25 SK	546385	●	6	90	80	13.5	25 - 55	Screw length - h _{nom}	T30	100
FBS II 6 x 100/45 SK	546386	●	6	110	100	13.5	25 - 55	Screw length - h _{nom}	T30	100
FBS II 6 x 120/65 SK	546387	●	6	130	120	13.5	25 - 55	Screw length - h _{nom}	T30	100
FBS II 6 x 140/85 SK	546388	●	6	150	140	13.5	25 - 55	Screw length - h _{nom}	T30	100
FBS II 6 x 160/105 SK	546389	●	6	170	160	13.5	25 - 55	Screw length - h _{nom}	T30	100
FBS II 6 x 40/5 US	546390	●	6	50	40	17	25 - 35	Screw length - h _{nom}	SW 10	100
FBS II 6 x 60/5 US	546391	●	6	70	60	17	25 - 55	Screw length - h _{nom}	SW 10	100
FBS II 6 x 80/25 US	546392	●	6	90	80	17	25 - 55	Screw length - h _{nom}	SW 10	100
FBS II 6 x 100/45 US	546393	●	6	110	100	17	25 - 55	Screw length - h _{nom}	SW 10	100
FBS II 6 x 120/65 US	546394	●	6	130	120	17	25 - 55	Screw length - h _{nom}	SW 10	100

Technical data

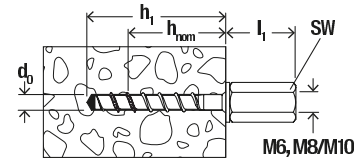
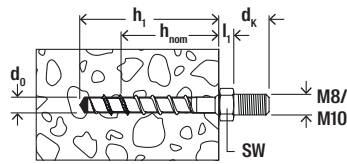
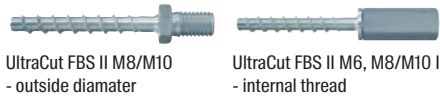

Item	Item No.	Approval ETA	Drill hole diameter d_0 [mm]	Min. drill hole depth for pre-positioned installation h_1 [mm]	Projection length l_1 [mm]	Screw-in depth h_{nom} [mm]	Drive	Sales unit [pcs]
FBS II 6 x 25 M8/19	546395	●	6	35	19	25	SW 10	100
FBS II 6 x 35 M8/19	546396	●	6	45	19	35	SW 10	100
FBS II 6 x 55 M8/19	546397	●	6	65	19	55	SW 10	100
FBS II 6 x 35 M10/21	546398	●	6	45	21	35	SW 13	100
FBS II 6 x 55 M10/21	546399	●	6	65	21	55	SW 13	100
FBS II 6 x 35 M6 I	554065	●	6	—	—	—	SW 13	—
FBS II 6 x 55 M6 I	554066	●	6	—	—	—	SW 13	—
FBS II 6 x 35 M8/M10 I	546400	●	6	45	37	35	SW 13	100
FBS II 6 x 55 M8/M10 I	546401	●	6	65	37	55	SW 13	100

High performance steel anchors

Hammerset anchor EA II

The internally threaded anchor with rim for simple hammerset installation

8 Technical data

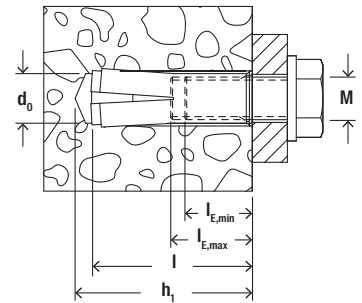
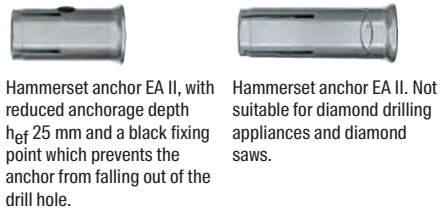

Item	Zinc-plated steel Item No. gvz	Stainless steel Item No. R	Approval ETA	Drill hole diameter d_0 [mm]	Min. drill hole depth for pre-positioned installation h_1 [mm]	Anchor length l [mm]	Internal thread M	Min. bolt penetration $l_{E,min}$ [mm]	Max. bolt penetration $l_{E,max}$ [mm]	Sales unit [pcs]
EA II M 6 x 25	532230	—	●	8	27	25	M 6	6	14	100
EA II M 6 x 30	048264	048410	●	8	32	30	M 6	6	14	100
EA II M 8 x 25	532231	—	●	10	27	25	M 8	8	14	100
EA II M 8 x 30	048284	048411	●	10	33	30	M 8	8	14	100
EA II M 8 x 40	048323	048412	●	10	43	40	M 8	8	14	50
EA II M 10 x 25	532232	—	●	12	27	25	M 10	10	14	50
EA II M 10 x 30	048332	—	●	12	33	30	M 10	10	14	50
EA II M 10 x 40	048339	048414	●	12	43	40	M 10	10	17	50
EA II M 12 x 25	532233	—	●	15	27	25	M 12	12	14	25
EA II M 12 x 50	048406	048415	●	15	54	50	M 12	12	22	25
EA II M 16 x 65	048408	048416	●	20	70	65	M 16	16	28	20
EA II M 20 x 80	048409	048417	●	25	85	80	M 20	20	34	10

Technical data



Stop drill EBB

Item	Item No.	Tool holder	Drill hole diameter d ₀ [mm]	Drill hole depth h ₀ [mm]	Match	Sales unit [pcs]
EBB 8 x 25	532607	SDS plus	8	27	EA II M 6 x 25	1
EBB 10 x 25	532608	SDS plus	10	27	EA II M 8 x 25	1
EBB 12 x 25	532609	SDS plus	12	27	EA II M 10 x 25	1
EBB 15 x 25	532610	SDS plus	15	27	EA II M 12 x 25	1

Technical data



Machine setting tool EMS

Item	Item No.	Tool holder	Match	Sales unit [pcs]
EMS M 6 x 25/30	048065	SDS plus	EA II M 6 x 25, EA II M 6 x 30	1
EMS M 8 x 25/30	048066	SDS plus	EA II M 8 x 25, EA II M 8 x 30	1
EMS M 8 x 40	048067	SDS plus	EA II M 8 x 40	1
EMS M 10 x 25/30	048068	SDS plus	EA II M 10 x 25, EA II M 10 x 30	1
EMS M 10 x 40	048070	SDS plus	EA II M 10 x 40	1
EMS M 12 x 50	048071	SDS plus	EA II M 12 x 50 D, EA II M 12 x 50, EA M 12 x 50 N D	1
EMS M 16 x 65	048072 ¹⁾	SDS max	EA II M 16 x 65	1
EMS M 20 x 80	048073 ¹⁾	SDS max	EA II M 20 x 80	1

1) Delivery time on request.

Technical data



Setting tool EHS Plus with hand impact protection for your safety and embossing tool.

Item	Item No.	Match	Sales unit [pcs]
EHS M 6 x 25/30 Plus	044630	EA II M 6 x 25, EA II M 6 x 30	1
EHS M 8 x 25/30 Plus	044631	EA II M 8 x 25, EA II M 8 x 30	1
EHS M 8 x 40 Plus	044632	EA II M 8 x 40	1
EHS M 10 x 25/30 Plus	048487	EA II M 10 x 25, EA II M 10 x 30	1
EHS M 12 x 25 Plus	532568	EA II M 12 x 25	1
EHS M 10 x 40 Plus	044633	EA II M 10 x 40	1
EHS M 12 x 50 Plus	044634	EA II M 12 x 50, EA II M 12 x 50 D	1
EHS M 16 x 65 Plus	044635	EA II M 16 x 65	1
EHS M 20 x 80 Plus	044636	EA II M 20 x 80	1

High performance steel anchors

Nail anchor FNA II

The installation-friendly hammer-set anchor for multiple fixings

Technical data



Nail anchor FNA II with nail head

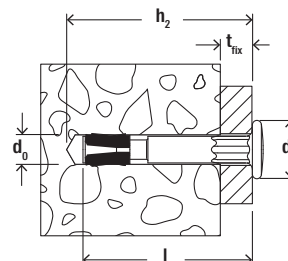

Item	Zinc-plated steel	Stainless steel	Highly corrosion resistant steel	Approval	Drill hole diameter	Min. drill hole depth for through fixings	Anchor length	Max. fixture thickness	Head-Ø	Sales unit
	Item No. gvz	Item No. R	Item No. HCR	ETA	d ₀ [mm]	h ₂ [mm]	l [mm]	t _{fix} [mm]	d _k [mm]	[pcs]
FNA II 6 x 25/5	044121 ¹⁾	—	—	●	6	40	35	5	13.0	100
FNA II 6 x 30/5	044115 ¹⁾	044122	—	●	6	45	40	5	13.0	100
FNA II 6 x 30/5	—	—	044124	●	6	45	40	5	13.0	25
FNA II 6 x 30/15	530419	—	—	●	6	55	50	15	13.0	50
FNA II 6 x 30/30	044116	044123	—	●	6	70	65	30	13.0	50
FNA II 6 x 30/30	—	—	044125	●	6	70	65	30	13.0	25
FNA II 6 x 30/40	—	046023	—	●	6	80	77	40	13.0	50
FNA II 6 x 30/50	044117	046024	500569	●	6	90	85	50	13.0	50
FNA II 6 x 30/60	—	046025	—	●	6	100	97	60	13.0	50
FNA II 6 x 30/75	044118	—	500573 ²⁾	●	6	115	110	75	13.0	50
FNA II 6 x 30/100	044119	—	500574 ²⁾	●	6	140	135	100	13.0	50
FNA II 6 x 30/120	044120	—	500575 ²⁾	●	6	160	155	120	13.0	50

1) With hexagon below the nail head for anti-rotation lock of hole and wire hangers (for example) and centring for optional setting tool FNA II S.

2) Delivery time on request.

8

Technical data



Nail anchor FNA II M6 with thread and flange nut

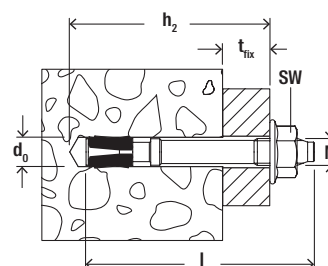

Item	Zinc-plated steel	Stainless steel	Highly corrosion resistant steel	Approval	Drill hole diameter	Min. drill hole depth for through fixings	Anchor length	Max. fixture thickness	Thread	Width across nut	Sales unit
	Item No. gvz	Item No. R	Item No. HCR	ETA	d ₀ [mm]	h ₂ [mm]	l [mm]	t _{fix} [mm]	M	SW [mm]	[pcs]
FNA II 6 x 25 M6/5	044111	—	—	●	6	40	45	5	M 6	10	100
FNA II 6 x 30 M6/5	044109	—	—	●	6	45	50	5	M 6	10	100
FNA II 6 x 30 M6/5	—	044112 ²⁾	—	●	6	45	50	5	M 6	10	50
FNA II 6 x 30 M6/5	—	—	044113 ²⁾	●	6	45	50	5	M 6	10	25

1) without nut; e.g. for fixing of pipe clamps

2) with nut and washer (no flange nut)

Technical data



Nail anchor FNA II M6 with thread and flange nut

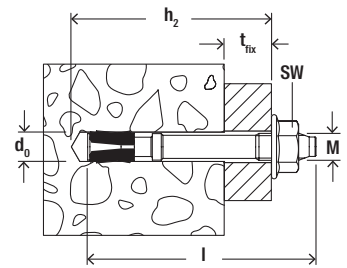

Item	Zinc-plated steel	Stainless steel	Highly corrosion resistant steel	Approval	Drill hole diameter	Min. drill hole depth for through fixings	Anchor length	Max. fixture thickness	Thread	Width across nut	Sales unit
	Item No. gvz	Item No. R	Item No. HCR	ETA	d_0 [mm]	h_2 [mm]	l [mm]	t_{fix} [mm]	M	SW [mm]	[pcs]
FNA II 6 x 30 M6 x 41	044110 ¹⁾	—	—	●	6	40	41	—	M 6	10	100
FNA II 6 x 30 M6/10	046022	—	—	●	6	45	55	10	M 6	10	100
FNA II 6 x 30 M8/5	044114	—	—	●	6	45	51	5	M 8	13	50

1) without nut; e.g. for fixing of pipe clamps

2) with nut and washer (no flange nut)

High performance steel anchors

Ceiling nail FDN II

The installation-friendly push-through anchor for multiple fixings

Technical data



Ceiling nail FDN II

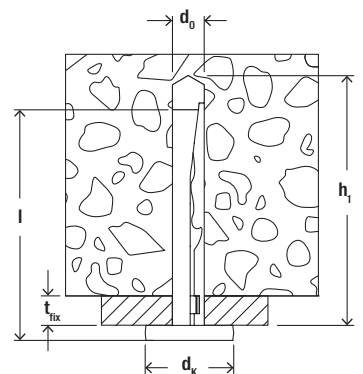

Item	Item No.	Approval	Drill diameter	Anchor length	Max. usable length	Min. drill hole depth without cleaning	Min. drill hole depth with cleaning	Head-Ø	Sales unit
		ETA	d_0 [mm]	l [mm]	t_{fix} [mm]	h_1 [mm]	h_1 [mm]	d_k [mm]	[pcs]
FDN II 6/5	545636	●	6	40	5	47	42	15	100
FDN II 6/35	545637	●	6	70	35	77	72	15	100
FDN II 6/5 K	545638	●	6	33	5	40	35	15	100
FDN II 6/35 K	545639	●	6	64	35	70	65	15	100

High performance steel anchors

Hollow-ceiling anchor FHY

The installation-friendly internally threaded anchor for fixings in pre-stressed hollow-core concrete slabs

Technical data



Hollow-ceiling anchor FHY

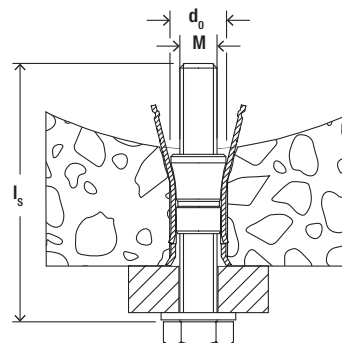

Item	Zinc-plated steel Item No. gvz	Stainless steel Item No. R	Approval DIBt	Drill hole diameter d_0 [mm]	Anchor length l [mm]	Thread M	Min. drill hole depth h_1 [mm]	Min. bolt penetration $l_{E,min}$ [mm]	Sales unit [pcs]
FHY M 6	030138	—	●	10	37	M 6	50	37	50
FHY M 6	—	030139	—	10	37	M 6	50	37	50
FHY M 8	030146	—	●	12	43	M 8	60	43	25
FHY M 8	—	030147	—	12	43	M 8	60	43	25
FHY M10	030148	—	●	16	52	M 10	65	52	20
FHY M10	—	030151	—	16	52	M 10	65	52	20
FHY M12	545512	—	—	18	52	M 12	65	52	25

High performance steel anchors

Aircrete anchor FPX-I

The strong internally threaded anchor with unique 4-way expansion for fixings in aerated concrete

Technical data



Aircrete anchor FPX-I

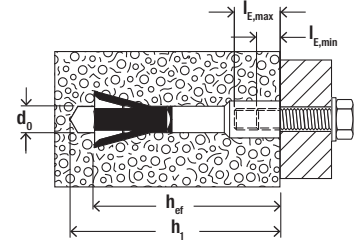

Item	Item No.	Approval	Drill diameter	Min. drill hole depth for pre-positioned installation	Anchor length	Effect. anchorage depth	Min. bolt penetration	Max. bolt penetration	Sales unit
		ETA	d_0 [mm]	h_1 [mm]	l [mm]	h_{ef} [mm]	$l_{E,min}$ [mm]	$l_{E,max}$ [mm]	[pcs]
FPX M6-I	519021	●	10	95	75	70	10	15	25
FPX M8-I	519022	●	10	95	75	70	8	15	25
FPX M10-I	519023	●	10	95	75	70	10	15	25
FPX M12-I	519024	●	10	95	75	70	12	15	25

Technical data



Setting tool FPX M6 I

Setting tool FPX M8-M12 I

Item	Item No.	Matching anchor type	Sales unit
			[pcs]
Setting tool FPX M6 I	522517	FPX M6-I	10
Setting tool FPX M8-M12 I	522518	FPX M8-I - FPX M12-I	10

Chemical fixings

Injection mortar FIS HB

The best performance in cracked concrete

Technical data

Injection mortar FIS HB 345 S + static mixer FIS MR Plus
Injection mortar FIS HB 150 C

Item	Item No.	Approval ETA	Languages on the cartridge	Scale unit	Contents	Sales unit [pcs]
FIS HB 150 C	519665	●	DE, FR, NL	70	1 cartridge 145 ml, 2 x FIS MR Plus	6
FIS HB 345 S	033211 ¹⁾	●	DE, EN, FR, ES, NL, CS	180	1 cartridge 360 ml, 2 x FIS MR Plus	6
FIS MR Plus	545853	—	—	—	10 static mixer FIS MR Plus	10

1) incl. 2 static mixer per cartridge.

Chemical fixings

Highbond-Resin Capsule FHB II-P / PF

8 The best performance in cracked concrete

Technical data

Resin capsule FHB II-P
(standard)

Item	Item No.	Approval ETA	Drill hole diameter d_0 [mm]	Drill hole depth h_0 [mm]	Anchorage depth h_{ef} [mm]	Match	Sales unit [pcs]
FHB II-P 8 x 60	096824	●	10	75	60	FHB II-A L M 8 x 60	10
FHB II-P 10 x 60	096847	●	10	75	60	FHB II-S M 10 x 60	10
FHB II-P 10 x 75	508016	●	10	90	75	FHB II-A S M 10 x 75	10
FHB II-P 10 x 95	096843	●	12	110	95	FHB II-A L M 10 x 95	10
FHB II-P 12 x 75	096848	●	12	90	75	FHB II-A S M 12 x 75	10
FHB II-P 12 x 100	507922	●	14	115	100	FHB II-A L M 12 x 100	10
FHB II-P 12 x 120	096844	●	14	135	120	FHB II-A L M 12 x 120	10
FHB II-P 16 x 95	096849	●	16	110	95	FHB II-A S M 16 x 95	10
FHB II-P 16 x 125	507923	●	18	140	125	FHB II-A L M 16 x 125	10
FHB II-P 16 x 145	507924	●	18	160	145	FHB II-A L M 16 x 145	10
FHB II-P 16 x 160	096845	●	18	175	160	FHB II-A L M 16 x 160	10
FHB II-P 20 x 170	507925	●	25	190	170	FHB II-A S M 20 x 170	4
FHB II-P 20 x 210	096846	●	25	235	210	FHB II-A L M 20 x 210	4
FHB II-P 24 x 170	096851	●	25	190	170	FHB II-A S M 24 x 170	4
FHB II-P 24 x 210	507926	●	25	235	210	FHB II-A L M 24 x 210	4

Technical data



Resin capsule FHB II-PF HIGH SPEED (quick version)

Item	Item No.	Approval ETA	Drill hole diameter	Drill hole depth	Anchorage depth	Match	Sales unit
			d_0 [mm]	h_0 [mm]	h_{ef} [mm]		[pcs]
FHB II-PF 8 x 60	500542	●	10	75	60	FHB II-A L M 8 x 60	10
FHB II-PF 10 x 60	500547	●	10	75	60	FHB II-S M 10 x 60	10
FHB II-PF 10 x 75	507999	●	10	90	75	FHB II-A S M 10 x 75	10
FHB II-PF 10 x 95	500543	●	12	110	95	FHB II-A L M 10 x 95	10
FHB II-PF 12 x 75	500548	●	12	90	75	FHB II-A S M 12 x 75	10
FHB II-PF 12 x 100	508000	●	14	115	100	FHB II-A L M 12 x 100	10
FHB II-PF 12 x 120	500544	●	14	135	120	FHB II-A L M 12 x 120	10
FHB II-PF 16 x 95	500549	●	16	110	95	FHB II-A S M 16 x 95	10
FHB II-PF 16 x 125	508001	●	18	140	125	FHB II-A L M 16 x 125	10
FHB II-PF 16 x 145	508002	●	18	160	145	FHB II-A L M 16 x 145	10
FHB II-PF 16 x 160	500545	●	18	175	160	FHB II-A L M 16 x 160	10
FHB II-PF 20 x 170	508003	●	25	190	170	FHB II-A S M 20 x 170	4
FHB II-PF 20 x 210	500546	●	25	235	210	FHB II-A L M 20 x 210	4
FHB II-PF 24 x 170	500550	●	25	190	170	FHB II-A S M 24 x 170	4
FHB II-PF 24 x 210	508004	●	25	235	210	FHB II-A L M 24 x 210	4

Chemical fixings

Highbond anchor FHB II-A S / L

The best performance in cracked concrete with the least installation effort

8

Technical data



Highbond anchor FHB II-A S (short version)

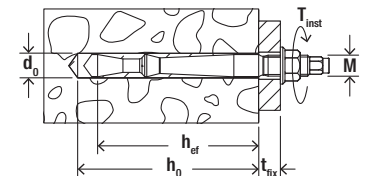

Item	Zinc-plated steel	Stainless steel	Highly corrosion resistant steel	Approval ETA	Drill hole diameter	Drill hole depth	Anchorage depth	Usable length	Thread M	Width across nut	Sales unit [pcs]
	Item No. gvz	Item No. A4	Item No. C		d_0 [mm]	h_0 [mm]	h_{ef} [mm]	t_{fix} [mm]		SW [mm]	
FHB II-A S M10 x 60/10	097072	097630	097704 ¹⁾	●	10	75	60	10	M 10	17	10
FHB II-A S M10 x 60/20	097073	097631	—	●	10	75	60	20	M 10	17	10
FHB II-A S M10 x 60/30	—	050571	—	●	10	75	60	30	M 10	17	10
FHB II-A S M10 x 60/40	—	097632	—	●	10	75	60	40	M 10	17	10
FHB II-A S M10 x 60/60	097074	097633	—	●	10	75	60	60	M 10	17	10
FHB II-A S M10 x 60/100	097206	097634	—	●	10	75	60	100	M 10	17	10
FHB II-A S M10 x 75/10	506884	506888	—	●	10	90	75	10	M 10	17	10
FHB II-A S M10 x 75/20	506885	506889	—	●	10	90	75	20	M 10	17	10
FHB II-A S M10 x 75/40	—	506890	—	●	10	90	75	40	M 10	17	10
FHB II-A S M10 x 75/60	506886	506891	—	●	10	90	75	60	M 10	17	10
FHB II-A S M10 x 75/100	506887	506892	—	●	10	90	75	100	M 10	17	10
FHB II-A S M12 x 75/10	097257	097635	—	●	12	90	75	10	M 12	19	10
FHB II-A S M12 x 75/25	097268	097636	097706 ¹⁾	●	12	90	75	25	M 12	19	10

¹⁾ Delivery time on request.

Technical data



Highbond anchor FHB II-A S (short version)

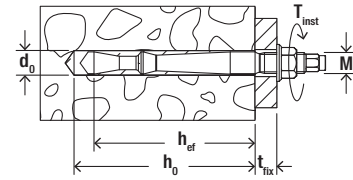

Item	Zinc-plated steel	Stainless steel	Highly corrosion resistant steel	Approval	Drill hole diameter	Drill hole depth	Anchorage depth	Usable length	Thread	Width across nut	Sales unit
	Item No. gvz	Item No. A4	Item No. C	ETA	d ₀ [mm]	h ₀ [mm]	h _{ef} [mm]	t _{fix} [mm]	M	SW [mm]	[pcs]
FHB II-A S M12 x 75/40	—	097637	—	●	12	90	75	40	M 12	19	10
FHB II-A S M12 x 75/60	097274	097638	—	●	12	90	75	60	M 12	19	10
FHB II-A S M12 x 75/100	097275	097639	—	●	12	90	75	100	M 12	19	10
FHB II-A S M12 x 75/165	097280	097640	—	●	12	90	75	165	M 12	19	10
FHB II-A S M16 x 95/30	097281	097641	097708 ¹⁾	●	16	110	95	30	M 16	24	10
FHB II-A S M16 x 95/60	097286	097642	—	●	16	110	95	60	M 16	24	10
FHB II-A S M16 x 95/100	097295	097643	—	●	16	110	95	100	M 16	24	10
FHB II-A S M16 x 95/165	097296	097644	—	●	16	110	95	165	M 16	24	10
FHB II-A S M20 x 170/50	506917	506919	—	●	25	190	170	50	M 20	30	4
FHB II-A S M24 x 170/50	097297	097645	—	●	25	190	170	50	M 24	36	4
FHB II-A S M24 x 170/70	552057	—	—	●	25	190	170	70	M 24	36	4

¹⁾ Delivery time on request.

Technical data



Highbond anchor FHB II-A L (long version)

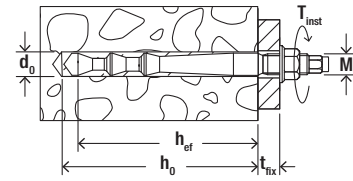

Item	Zinc-plated steel	Stainless steel	Highly corrosion resistant steel	Approval	Drill hole diameter	Drill hole depth	Anchorage depth	Usable length	Thread	Width across nut	Sales unit
	Item No. gvz	Item No. A4	Item No. C	ETA	d ₀ [mm]	h ₀ [mm]	h _{ef} [mm]	t _{fix} [mm]	M	SW [mm]	[pcs]
FHB II-A L M8 x 60/10	097032	097298	097696 ¹⁾	●	10	75	60	10	M 8	13	10
FHB II-A L M8 x 60/30	097033	097299	—	●	10	75	60	30	M 8	13	10
FHB II-A L M8 x 60/50	097034	097440	—	●	10	75	60	50	M 8	13	10
FHB II-A L M10 x 95/10	096907	097616	—	●	12	110	95	10	M 10	17	10
FHB II-A L M10 x 95/20	096940	097617	097699 ¹⁾	●	12	110	95	20	M 10	17	10
FHB II-A L M10 x 95/40	—	097618	—	●	12	110	95	40	M 10	17	10
FHB II-A L M10 x 95/60	096941	097619	—	●	12	110	95	60	M 10	17	10
FHB II-A L M10 x 95/100	096942	097620	—	●	12	110	95	100	M 10	17	10
FHB II-A L M12 x 100/10	506893	506897	—	●	14	115	100	10	M 12	19	10
FHB II-A L M12 x 100/25	506894	506898	—	●	14	115	100	25	M 12	19	10
FHB II-A L M12 x 100/40	—	506899	—	●	14	115	100	40	M 12	19	10
FHB II-A L M12 x 100/50 GS	—	537065	—	●	14	115	100	50	M 12	19	10
FHB II-A L M12 x 100/60	506895	506901	—	●	14	115	100	60	M 12	19	10
FHB II-A L M12 x 100/100	506896	506902	—	●	14	115	100	100	M 12	19	10
FHB II-A L M12 x 120/10	096943	097621	—	●	14	135	120	10	M 12	19	10
FHB II-A L M12 x 120/25	096944	097622	097700 ¹⁾	●	14	135	120	25	M 12	19	10
FHB II-A L M12 x 120/40	—	097623	—	●	14	135	120	40	M 12	19	10
FHB II-A L M12 x 120/60	097014	097624	—	●	14	135	120	60	M 12	19	10
FHB II-A L M12 x 120/100	097031	097625	—	●	14	135	120	100	M 12	19	10
FHB II-A L M16 x 125/30	506903	506906	—	●	18	140	125	30	M 16	24	10
FHB II-A L M16 x 125/60	506904	506909	—	●	18	140	125	60	M 16	24	10
FHB II-A L M16 x 125/100	506905	506910	—	●	18	140	125	100	M 16	24	10

¹⁾ Delivery time on request.

Technical data

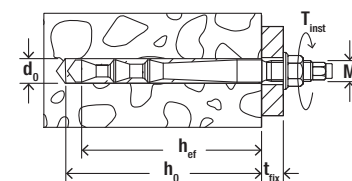
Highbond anchor FHB II-A L
(long version)

Item	Zinc-plated steel	Stainless steel	Highly corrosion resistant steel	Approval	Drill hole diameter	Drill hole depth	Anchorage depth	Usable length	Thread	Width across nut	Sales unit
	Item No. gvz	Item No. A4	Item No. C	ETA	d_0 [mm]	h_0 [mm]	h_{ef} [mm]	t_{fix} [mm]	M	SW [mm]	[pcs]
FHB II-A L M16 x 145/30	506911	506914	—	●	18	160	145	30	M 16	24	10
FHB II-A L M16 x 145/60	506912	506915	—	●	18	160	145	60	M 16	24	10
FHB II-A L M16 x 145/100	506913	506916	—	●	18	160	145	100	M 16	24	10
FHB II-A L M16 x 160/30	097035	097626	097702 ¹⁾	●	18	175	160	30	M 16	24	10
FHB II-A L M16 x 160/60	097038	097627	—	●	18	175	160	60	M 16	24	10
FHB II-A L M16 x 160/100	097070	097628	—	●	18	175	160	100	M 16	24	10
FHB II-A L M20 x 210/50	097071	097629	097703 ¹⁾	●	25	235	210	50	M 20	30	4
FHB II-A L M20 x 210/150	052370	—	—	●	25	235	210	150	M 20	30	8
FHB II-A L M20 x 210/200	552056	—	—	●	25	235	210	200	M 20	30	8
FHB II-A L M24 x 210/50	506920	506921	—	●	25	235	210	50	M 24	36	4

1) Delivery time on request.

Chemical fixings

Superbond mortar FIS SB

The concrete-allrounder

Technical data

Superbond mortar
FIS SB 390 S

Static mixer FIS MR Plus

Item	Item No.	Approval		Languages on the cartridge	Scale unit	Contents	Sales unit
		ETA	ICC				
FIS SB 390 S	519451	●	●	DE, FR, NL	180	1 cartridge 390 ml, 2 x FIS MR Plus	6
FIS SB 390 S	520557	●	●	DE, SL, SR, BG	180	1 cartridge 390 ml, 2 x FIS MR Plus	6
FIS SB 390 S	518831	●	●	EN, ES, PT	180	1 cartridge 390 ml, 2 x FIS MR Plus	6
FIS SB 390 S	519450	●	●	IT, DE, EN	180	1 cartridge 390 ml, 2 x FIS MR Plus	6
FIS SB 390 S	520559	●	●	DA, SV, NO, FI	180	1 cartridge 390 ml, 2 x FIS MR Plus	6
FIS SB 390 S	520555	●	●	CS, SK, RO	180	1 cartridge 390 ml, 2 x FIS MR Plus	6
FIS SB 390 S	520595	●	●	PL, RU, HU	180	1 cartridge 390 ml, 2 x FIS MR Plus	6
FIS SB 585 S	519452	●	●	EN, ES, PT	270	1 cartridge 585 ml + 2 x FIS UMR	6
FIS SB 585 S	520526	●	●	IT, DE, EN	270	1 cartridge 585 ml + 2 x FIS UMR	6
FIS SB HIGH SPEED 390 S	523303	●	—	PL, RU, HU	180	1 cartridge 390 ml, 2 x FIS MR Plus	6
FIS MR Plus	545853	—	—	—	—	10 static mixer FIS MR Plus	10
FIS UMR	520593	—	—	—	—	10 static mixer FIS UMR for 585 ml and 1500 ml cartridges	10

Technical data in concrete



Threaded rod FIS A

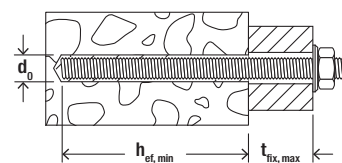

Item	Zinc plated, steel grade 5.8	Zinc plated, steel grade 8.8	Stainless steel	Approval		Drill hole diameter d_0 [mm]	Min. / max. anchorage depth [mm]	Min. / max. usable length [mm]	Min. / max. filling quantity FIS SB [scale units]	Sales unit [pcs]
	Item No. gvz	Item No. gvz	Item No. R	ETA	ICC					
FIS A M 8 x 90	090274	519390	090440	●	●	10	60 / 78	1 / 19	2 / 3	10
FIS A M 8 x 110	090275	519391	090441	●	●	10	60 / 98	1 / 39	2 / 3	10
FIS A M 8 x 130	090276	519392	090442	●	●	10	60 / 118	1 / 59	2 / 4	10
FIS A M 8 x 175	090277	519393	090443	●	●	10	60 / 160	4 / 104	2 / 5	10
FIS A M 8 x 1000	509214 ¹⁾	—	509230 ¹⁾	●	●	10	60 / 160	—	2 / 5	10
FIS A M 10 x 110	090278	—	090444	●	●	12	60 / 96	1 / 37	3 / 4	10
FIS A M 10 x 130	090279	524170	090447	●	●	12	60 / 116	1 / 57	3 / 5	10
FIS A M 10 x 150	090281	517935	090448	●	●	12	60 / 136	1 / 77	3 / 5	10
FIS A M 10 x 170	044969	519395	044973	●	●	12	60 / 156	1 / 97	3 / 6	10
FIS A M 10 x 190	—	517936	—	●	●	12	60 / 176	1 / 117	3 / 7	10
FIS A M 10 x 200	090282	519396	090449	●	●	12	60 / 186	1 / 127	3 / 7	10
FIS A M 10 x 1000	509215 ¹⁾	509223 ¹⁾	509231 ¹⁾	●	●	12	60 / 200	—	3 / 7	10
FIS A M 12 x 120	044971	519397	044974	●	●	14	70 / 103	1 / 34	3 / 5	10
FIS A M 12 x 140	090283	519398	090450	●	●	14	70 / 123	1 / 54	3 / 6	10
FIS A M 12 x 160	090284	517937	090451	●	●	14	70 / 143	1 / 74	3 / 7	10
FIS A M 12 x 180	090285	519399	090452	●	●	14	70 / 163	1 / 94	3 / 7	10
FIS A M 12 x 200	—	517938	—	●	●	14	70 / 183	1 / 114	3 / 8	10
FIS A M 12 x 210	090286	—	090453	●	●	14	70 / 193	1 / 124	3 / 9	10
FIS A M 12 x 260	090287	—	090454	●	●	14	70 / 240	4 / 174	3 / 10	10
FIS A M 12 x 1000	509216 ¹⁾	509224 ¹⁾	509232 ¹⁾	●	●	14	70 / 240	—	3 / 10	10
FIS A M 16 x 130	044972	519400	044975	●	●	18	80 / 109	1 / 30	5 / 7	10
FIS A M 16 x 175	090288	519401	090455	●	●	18	80 / 154	1 / 75	5 / 10	10
FIS A M 16 x 200	090289	517939	090456	●	●	18	80 / 179	1 / 100	5 / 11	10
FIS A M 16 x 250	090290	517940	090457	●	●	18	80 / 229	1 / 150	5 / 14	10
FIS A M 16 x 300	090291	519402	090458	●	●	18	80 / 279	1 / 200	5 / 17	10
FIS A M 16 x 1000	509217 ¹⁾	509225 ¹⁾	509233 ¹⁾	●	●	18	80 / 320	—	5 / 19	10
FIS A M 20 x 245	090292	519404	090459	●	●	24	90 / 220	1 / 131	11 / 28	10
FIS A M 20 x 290	090293	519406	090460	●	●	24	90 / 265	1 / 176	11 / 32	10
FIS A M 20 x 1000	—	519410 ¹⁾	519427 ¹⁾	●	●	24	90 / 400	—	11 / 48	10
FIS A M 24 x 290	090294	—	090461	●	●	28	96 / 260	1 / 165	15 / 39	5
FIS A M 24 x 380	090295	—	090462	●	●	28	96 / 350	1 / 255	15 / 52	5
FIS A M 30 x 430	090297	—	090464	●	●	35	120 / 394	1 / 275	27 / 88	5

1) Order washer and nut separately.

Chemical fixings

Injection mortar FIS V

The versatile injection mortar for anchorings in cracked concrete and masonry

Technical data



Injection mortar FIS V 300 T Injection mortar FIS V 360 S Injection mortar FIS V 410 C Static mixer FIS MR Plus

Item	Item No.	Approval			Languages on the cartridge	Scale unit	Contents	Sales unit [pcs]
		DIBt	ETA	ICC				
FIS V 300 T	531573	●	●	●	USA, RA, BR, MEX	150	1 cartridge 300 ml, 2 x FIS MR Plus	12
FIS V 360 S	559131	●	●	●	EN, ES, PT	180	1 cartridge 360 ml, 2 x FIS MR Plus	6
FIS V 360 S	559132	●	●	●	DK, NO, SE, FI	180	1 cartridge 360 ml, 2 x FIS MR Plus	6
FIS V 360 S	559133	●	●	●	CS, SK, HU	180	1 cartridge 360 ml, 2 x FIS MR Plus	6
FIS V 360 S	559429	●	●	●	DE, FR, NL	180	1 cartridge 360 ml, 2 x FIS MR Plus	6
FIS V 360 S	559432	●	●	●	RU, UK, KK	180	1 cartridge 360 ml, 2 x FIS MR Plus	6
FIS V 360 S	559435	●	●	●	IT, PL, RO	180	1 cartridge 360 ml, 2 x FIS MR Plus	6
FIS V 410 C	521431	●	●	●	IT, DE, EN	270	1 cartridge 410 ml, 2 x FIS MR Plus	16
FIS V 410 C	534880	●	●	●	PL, LT, LV, ET, RU	200	1 cartridge 410 ml, 2 x FIS MR Plus	12
FIS V 410 C	538131	●	●	●	USA, RA, BR, MEX	200	1 cartridge 410 ml, 2 x FIS MR Plus	12
FIS MR Plus	545853	—	—	—	—	—	10 static mixer FIS MR Plus	10

Technical data in perforated brick masonry



Threaded rod FIS A

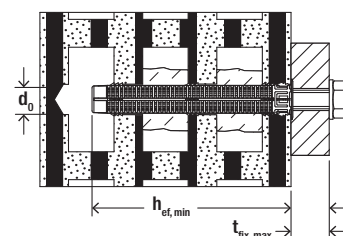

Item	Zinc plated, steel grade 5.8 Item No. gvz	Zinc plated, steel grade 8.8 Item No. gvz	Stainless steel Item No. A4	Approval ETA	Drill hole diameter in perforated brick masonry d_0 [mm]	Min. anchorage depth in perforated brick masonry $h_{ef, min}$ [mm]	Max. useful length in perforated brick masonry $t_{fix, max}$ [mm]	Suitable injection anchor sleeve	Sales unit [pcs]
FIS A M 6 x 70	046204	—	—	●	12	50	11	FIS H 12 x 50 K	10
FIS A M 6 x 75	090243	—	090437	●	12	50	16	FIS H 12 x 50 K	20
FIS A M 6 x 85	090272	—	—	●	12	50	26	FIS H 12 x 50 K	20
FIS A M 6 x 110	090273	—	090439	●	12	50 85	52 17	FIS H 12 x 50 K FIS H 12 x 85 K	20
FIS A M 8 x 90	090274	519390	090440	●	12	50	29	FIS H 12 x 50 K	10
FIS A M 8 x 110	090275	519391	090441	●	12 12 16	50 85 85	49 14 14	FIS H 12 x 50 K FIS H 12 x 85 K FIS H 16 x 85 K	10
FIS A M 8 x 130	090276	519392	090442	●	12 12 16	50 85 85	69 34 34	FIS H 12 x 50 K FIS H 12 x 85 K FIS H 16 x 85 K	10
FIS A M 8 x 175	090277	519393	090443	●	12 12 16 16	50 85 85 130	114 79 79 34	FIS H 12 x 50 K FIS H 12 x 85 K FIS H 16 x 85 K FIS H 16 x 130 K	10

Technical data in perforated brick masonry



Threaded rod FIS A

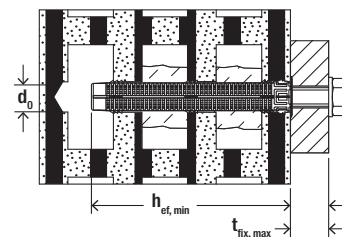

Item	Zinc plated, steel grade 5.8	Zinc plated, steel grade 8.8	Stainless steel	Approval	Drill hole diameter in perforated brick masonry	Min. anchorage depth in perforated brick masonry	Max. useful length in perforated brick masonry	Suitable injection anchor sleeve	Sales unit
	Item No. gvz	Item No. gvz	Item No. A4	ETA	d_0 [mm]	$h_{ef, min}$ [mm]	$t_{fix, max}$ [mm]		[pcs]
FIS A M 10 x 110	090278	—	090444	●	16	85	12	FIS H 16 x 85 K	10
FIS A M 10 x 130	090279	524170	090447	●	16	85	32	FIS H 16 x 85 K	10
FIS A M 10 x 150	090281	517935	090448	●	16	85 130	52 7	FIS H 16 x 85 K FIS H 16 x 130 K	10
FIS A M 10 x 170	044969	519395	044973	●	16	85 130	72 27	FIS H 16 x 85 K FIS H 16 x 130 K	10
FIS A M 10 x 190	—	517936	—	●	16	85 130	92 47	FIS H 16 x 85 K FIS H 16 x 130 K	10
FIS A M 10 x 200	090282	519396	090449	●	16	85 130	102 57	FIS H 16 x 85 K FIS H 16 x 130 K	10
FIS A M 12 x 120	044971	519397	044974	●	20	85	19	FIS H 20 x 85 K	10
FIS A M 12 x 140	090283	519398	090450	●	20	85	39	FIS H 20 x 85 K	10
FIS A M 12 x 160	090284	517937	090451	●	20	85 130	59 14	FIS H 20 x 85 K FIS H 20 x 130 K	10
FIS A M 12 x 180	090285	519399	090452	●	20	85 130	79 34	FIS H 20 x 85 K FIS H 20 x 130 K	10
FIS A M 12 x 200	—	517938	—	●	20	85 130	99 54	FIS H 20 x 85 K FIS H 20 x 130 K	10
FIS A M 12 x 210	090286	—	090453	●	20	85 130	109 64	FIS H 20 x 85 K FIS H 20 x 130 K	10
FIS A M 12 x 260	090287	—	090454	●	20	85 130 200	169 114 44	FIS H 20 x 85 K FIS H 20 x 130 K FIS H 20 x 200 K	10
FIS A M 16 x 130	044972	519400	044975	●	20	85	25	FIS H 20 x 85 K	10
FIS A M 16 x 175	090288	519401	090455	●	20	85 130	70 25	FIS H 20 x 85 K FIS H 20 x 130 K	10
FIS A M 16 x 200	090289	517939	090456	●	20	85 130	95 50	FIS H 20 x 85 K FIS H 20 x 130 K	10
FIS A M 16 x 250	090290	517940	090457	●	20	85 130 200	145 100 30	FIS H 20 x 85 K FIS H 20 x 130 K FIS H 20 x 200 K	10
FIS A M 16 x 300	090291	519402	090458	●	20	85 130 200	195 150 80	FIS H 20 x 85 K FIS H 20 x 130 K FIS H 20 x 200 K	10

Technical data

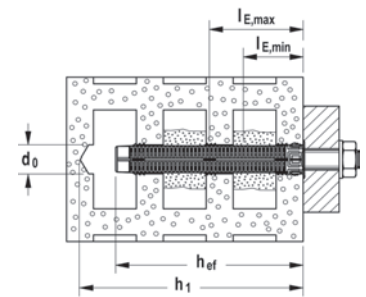
 Injection anchor sleeve
FIS H K

Item	Item No. gvz	Approval ETA	Drill hole diameter d_0 [mm]	Drill hole depth acc. ETA [mm]	Effect. anchorage depth h_{ef} [mm]	Match	Fill quantity per sleeve [scale units]	Sales unit [pcs]
FIS H 12 x 50 K	041900	●	12	55	50	FIS A M6-M8	5	50
FIS H 12 x 85 K	041901	●	12	90	85	FIS A M6-M8	10	50
FIS H 16 x 85 K	041902	●	16	90	85	FIS A M8-M10, FIS E M6-M8	12	50
FIS H 16 x 130 K	041903	●	16	135	110	FIS A M8-M10	15	20
FIS H 20 x 85 K	041904	●	20	90	85	FIS A M12-M16, FIS E M10-M12	15	20
FIS H 20 x 130 K	046703	●	20	135	110	FIS A M12-M16	25	20
FIS H 20 x 200 K	046704	●	20	205	180	FIS A M12-M16	40	20

Technical data in solid brick masonry

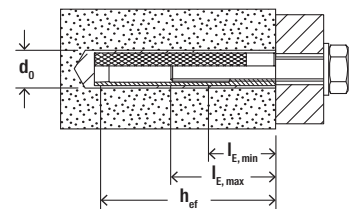
 Internal threaded sockets
FIS E

Item	Zinc-plated steel	Approval ETA	Drill hole diameter d_0 [mm]	Effect. anchorage depth h_{ef} [mm]	Min. bolt penetration $l_{E,min}$ [mm]	Max. bolt penetration $l_{E,max}$ [mm]	Fill quantity for effect. anchorage depth in solid brick masonry [scale units]	Sales unit [pcs]
FIS E 11 x 85 M6	043631	●	14	85	6	60	4	10
FIS E 11 x 85 M8	043632	●	14	85	8	60	4	10
FIS E 15 x 85 M10	043633	●	18	85	10	60	5	10
FIS E 15 x 85 M12	043634	●	18	85	12	60	5	10

Technical data



FIS VL 300 T

FIS VL 410 C

FIS VL 410 C in bucket

Static mixer FIS MR Plus

Item	Item No.	Approval ETA	Languages on the cartridge	Scale unit	Contents	Sales unit [pcs]
FIS VL 300 T with clip	537149	●	PT, ES, EN	150	1 cartridge 300 ml, 2 x FIS MR Plus	12
FIS VL 300 T with clip	538583	●	CS, SK	150	1 cartridge 300 ml, 2 x FIS MR Plus	10
FIS VL 300 T HIGH SPEED with clip	538585	●	CS, SK	150	1 cartridge 380 ml, 2 x FIS MR Plus	10
FIS VL 300 T	539461	●	EN, FR, ES, PT, RO, AR	150	1 cartridge 300 ml, 2 x FIS MR Plus	12
FIS VL 300 T in bucket	539462	●	EN, FR, ES, PT, RO, AR	150	20 cartridges 300 ml, 40 x FIS MR Plus	1
FIS VL 300 T HWK big	538589	●	CS, SK	150	20 cartridges 300 ml, 40 x FIS MR Plus	1
FIS VL 410 C	539463	●	EN, FR, ES, PT, RO, AR	200	1 cartridge 410 ml, 2 x FIS MR Plus	12
FIS VL 410 C	538584	●	CS, SK	200	1 cartridge 410 ml, 2 x FIS MR Plus	12
FIS VL 410 C HIGH SPEED	538586	●	CS, SK	200	1 cartridge 410 ml, 1 x FIS MR Plus	12
FIS VL 410 C in bucket	538549	●	DE, FR, NL, EN, TR	200	16 cartridges 410 ml, 32 x FIS MR Plus	1
FIS VL 410 C in bucket	539464	●	EN, FR, ES, PT, RO, AR	200	16 cartridges 410 ml, 32 x FIS MR Plus	1
FIS VL 410 C HWK big	538590	●	CS, SK	200	16 cartridges 410 ml, 32 x FIS MR Plus	1
FIS MR Plus	545853	—	—	—	10 static mixer FIS MR Plus	10

Chemical fixings

Injection mortar FIS V Plus

The powerful universal mortar for concrete and masonry

Technical data



FIS V Plus 360 S

Item	Item No.	Approval			Languages on the cartridge	Contents	Sales unit [pcs]
		DIBt	ETA	ICC			
FIS V Plus 360 S (IN)	558744	●	●	●	EN	1 cartridge 360 ml, 2 x FIS MR Plus	6
FIS V Plus 360 S (DE)	558745	●	●	●	DE	1 cartridge 360 ml, 2 x FIS MR Plus	6
FIS V Plus 360 S (EN,ES,PT)	558746	●	●	●	EN, ES, PT	1 cartridge 360 ml, 2 x FIS MR Plus	6
FIS V Plus 360 S (AR,ZH,EN)	558747	●	●	●	AR, ZH, EN	1 cartridge 360 ml, 2 x FIS MR Plus	6
FIS V Plus 360 S (DE,FR,NL)	558752	●	●	●	DE, FR, NL	1 cartridge 360 ml, 2 x FIS MR Plus	6
FIS V Plus 360 S (IT,PL,RO)	558753	●	●	●	IT, PL, RO	1 cartridge 360 ml, 2 x FIS MR Plus	6
FIS V Plus 360 S (TR,EL,AR)	558754	●	●	●	TR, EL, AR	1 cartridge 360 ml, 2 x FIS MR Plus	6
FIS V Plus 360 S (DK,NO,SE,FI)	558755	●	●	●	DK, NO, SE, FI	1 cartridge 360 ml, 2 x FIS MR Plus	6
FIS V Plus 360 S (EN,ES,PT)	558758	●	●	●	EN, ES, PT	1 cartridge 360 ml, 2 x FIS MR Plus	6
FIS V Plus 360 S (RU,UK,KK)	558760	●	●	●	RU, UK, KK	1 cartridge 360 ml, 2 x FIS MR Plus	6
FIS V Plus 360 S (CS,SK,HU)	558762	●	●	●	CS, SK, HU	1 cartridge 360 ml, 2 x FIS MR Plus	6

Technical data



FIS V Plus 410 C

Item	Item No.	Approval			Languages on the cartridge	Contents	Sales unit [pcs]
		DIBt	ETA	ICC			
FIS V Plus 410 C (EN,ES,PT)	558784	●	●	●	EN, ES, PT	1 cartridge 410 ml, 2 x FIS MR Plus	12
FIS V Plus 410 C (IT,DE,EN)	558780	●	●	●	IT, DE, EN	1 cartridge 410 ml, 2 x FIS MR Plus	12

Frame fixings/Stand-off installation

Frame fixing SXR

The efficient with short expansion element

Technical data



SXR-FUS - with fischer hexagon head safety screw, moulded washer and integrated T40 bit recess

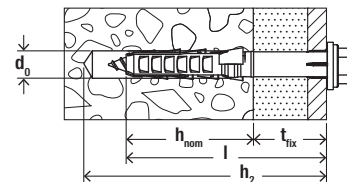

Item	Zinc-plated steel	Stainless steel	Hot-dip galvanised steel	Approval	Drill hole diameter	Min. drill hole depth for through fixings	Min. anchorage depth	Anchor length	Max. fixture thickness	Drive	Sales unit
	Item No. gvz	Item No. R	Item No. hdg	ETA	d_0 [mm]	h_2 [mm]	h_{nom} [mm]	l [mm]	t_{fix} [mm]		[pcs]
SXR 10 x 52 FUS	502456 ¹⁾	—	—	●	10	62	50	52	2	T40/SW13	50
SXR 10 x 60 FUS	046329	046339	—	●	10	70	50	60	10	T40/SW13	50
SXR 10 x 60 FUS	—	—	509537	—	10	70	50	60	10	T40/SW13	50
SXR 10 x 80 FUS	046330	046340	—	●	10	90	50	80	30	T40/SW13	50
SXR 10 x 80 FUS	—	—	509538	—	10	90	50	80	30	T40/SW13	50
SXR 10 x 100 FUS	046331	046342	—	●	10	110	50	100	50	T40/SW13	50
SXR 10 x 100 FUS	—	—	509539	—	10	110	50	100	50	T40/SW13	50
SXR 10 x 120 FUS	046332	046343	—	●	10	130	50	120	70	T40/SW13	50
SXR 10 x 140 FUS	046333	046344	—	●	10	150	50	140	90	T40/SW13	50
SXR 10 x 140 FUS	—	—	509540	—	10	150	50	140	90	T40/SW13	50
SXR 10 x 160 FUS	046334	046345	—	●	10	170	50	160	110	T40/SW13	50
SXR 10 x 180 FUS	046335	046361	—	●	10	190	50	180	130	T40/SW13	50
SXR 10 x 200 FUS	046336	046362	—	●	10	210	50	200	150	T40/SW13	50
SXR 10 x 230 FUS	046337	046363	—	●	10	240	50	230	180	T40/SW13	50
SXR 10 x 260 FUS	046338	—	—	●	10	270	50	260	210	T40/SW13	50

1) not pre-assembled

Frame fixings/Stand-off installation

Frame fixing SXRL

The versatile with multiple anchorage depth

Technical data



SXRL-FUS - with fischer hexagon head safety screw, moulded washer and integrated bit recess

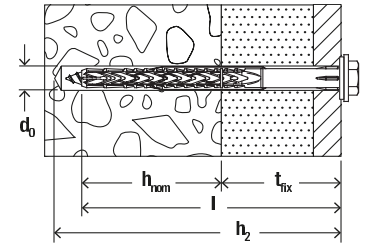

Item	Zinc-plated steel	Stainless steel	Approval		Drill diameter	Min. drill hole depth for through fixings	Usable length at anchorage depth 50mm	Usable length at anchorage depth 70mm	Usable length at anchorage depth 90mm	Anchor length	Drive	Sales unit
	Item No. gvz	Item No. R	ETA	DIBt	d ₀ [mm]	h ₂ [mm]	t _{fix} [mm]	t _{fix} [mm]	t _{fix} [mm]	l [mm]		[pcs]
SXRL 8 x 60 FUS	540127	540135	●	—	8	70	10	—	—	60	T30/SW10	50
SXRL 8 x 80 FUS	540129	540136	●	—	8	90	30	10	—	80	T30/SW10	50
SXRL 8 x 100 FUS	540130	540137	●	—	8	110	50	30	10	100	T30/SW10	50
SXRL 8 x 120 FUS	540131	—	●	—	8	130	70	50	30	120	T30/SW10	50
SXRL 8 x 140 FUS	540133	—	●	—	8	150	90	70	50	140	T30/SW10	50
SXRL 8 x 160 FUS	540134	—	●	—	8	170	110	90	70	160	T30/SW10	50
SXRL 10 x 60 FUS	546506	546507	●	●	10	70	10	—	—	60	T40/SW13	50
SXRL 10 x 80 FUS	522719	522730	●	●	10	90	30	10	—	80	T40/SW13	50
SXRL 10 x 100 FUS	522720	522731	●	●	10	110	50	30	10	100	T40/SW13	50
SXRL 10 x 120 FUS	522721	522732	●	●	10	130	70	50	30	120	T40/SW13	50
SXRL 10 x 140 FUS	522723	522733	●	●	10	150	90	70	50	140	T40/SW13	50
SXRL 10 x 160 FUS	522724	522734	●	●	10	170	110	90	70	160	T40/SW13	50
SXRL 10 x 180 FUS	522725	522735	●	●	10	190	130	110	90	180	T40/SW13	50
SXRL 10 x 200 FUS	522726	522736	●	●	10	210	150	130	110	200	T40/SW13	50
SXRL 10 x 230 FUS	522727	522737	●	●	10	240	180	160	140	230	T40/SW13	50
SXRL 10 x 260 FUS	522728 ¹⁾	522738 ¹⁾	●	●	10	270	210	190	170	260	T40/SW13	50
SXRL 10 x 290 FUS	522729 ¹⁾	522739 ¹⁾	●	●	10	300	240	220	200	290	T40/SW13	50
SXRL 14 x 80 FUS	530946	—	●	●	14	95	—	10	—	80	T50/SW17	50
SXRL 14 x 80 FUS	—	530955 ²⁾	●	●	14	95	—	10	—	80	SW 17	50
SXRL 14 x 100 FUS	530947	—	●	●	14	115	—	30	10	100	T50/SW17	50
SXRL 14 x 100 FUS	—	530956 ²⁾	●	●	14	115	—	30	10	100	SW 17	50
SXRL 14 x 120 FUS	530948	—	●	●	14	135	—	50	30	120	T50/SW17	50
SXRL 14 x 120 FUS	—	530957 ²⁾	●	●	14	135	—	50	30	120	SW 17	50
SXRL 14 x 140 FUS	530949	—	●	●	14	155	—	70	50	140	T50/SW17	50
SXRL 14 x 140 FUS	—	530958 ²⁾	●	●	14	155	—	70	50	140	SW 17	50
SXRL 14 x 160 FUS	530950	—	●	●	14	175	—	90	70	160	T50/SW17	50
SXRL 14 x 160 FUS	—	530959 ²⁾	●	●	14	175	—	90	70	160	SW 17	50
SXRL 14 x 180 FUS	530951	—	●	●	14	195	—	110	90	180	T50/SW17	50
SXRL 14 x 180 FUS	—	530960 ²⁾	●	●	14	195	—	110	90	180	SW 17	50
SXRL 14 x 200 FUS	530952	—	●	●	14	215	—	130	110	200	T50/SW17	50
SXRL 14 x 200 FUS	—	530961 ²⁾	●	●	14	215	—	130	110	200	SW 17	50
SXRL 14 x 230 FUS	530953	—	●	●	14	245	—	160	140	230	T50/SW17	50
SXRL 14 x 230 FUS	—	530962 ²⁾	●	●	14	245	—	160	140	230	SW 17	50
SXRL 14 x 260 FUS	530954	—	●	●	14	275	—	190	170	260	T50/SW17	50
SXRL 14 x 260 FUS	—	530963 ²⁾	●	●	14	275	—	190	170	260	SW 17	50

1) not pre-assembled

2) without integrated bit recess T50

Frame fixings/Stand-off installation

Stand-off installation TherMax 8/10

The thermally separated stand-off installation in external thermal insulation composite systems (ETICS)

Technical data



TherMax 8 and 10

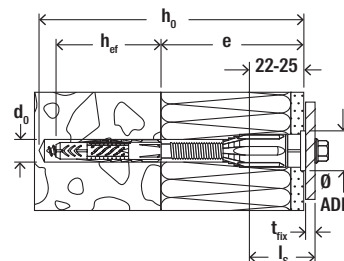

Item	Item No.	Drill hole diameter	Drill hole depth	Usable length	Anchorage depth	Cover cap-Ø	Width across nut	Chipboard / metric / sheet metal screw	Sales unit
		d ₀ [mm]	h ₀ [mm]	e [mm]	h _{ef} [mm]	ADK [mm]	SW [mm]		
TherMax 8/60 M6	045685	10	120	45 - 60	60	18	10	4,5 - 6,0 / M6 / 6,3	20
TherMax 8/80 M6	045686	10	140	60 - 80	60	18	10	4,5 - 6,0 / M6 / 6,3	20
TherMax 8/100 M6	045687	10	160	80 - 100	60	18	10	4,5 - 6,0 / M6 / 6,3	20
TherMax 8/120 M6	045688	10	180	100 - 120	60	18	10	4,5 - 6,0 / M6 / 6,3	20
TherMax 8/140 M6	045689	10	200	120 - 140	60	18	10	4,5 - 6,0 / M6 / 6,3	20
TherMax 8/160 M6	045690	10	220	140 - 160	60	18	10	4,5 - 6,0 / M6 / 6,3	20
TherMax 8/180 M6	045691	10	240	160 - 180	60	18	10	4,5 - 6,0 / M6 / 6,3	20
TherMax 10/100 M6	045692	12	160	80 - 100	70	22	13	4,5 - 6,0 / M6 / 6,3	20
TherMax 10/120 M6	045693	12	180	100 - 120	70	22	13	4,5 - 6,0 / M6 / 6,3	20
TherMax 10/140 M6	045694	12	200	120 - 140	70	22	13	4,5 - 6,0 / M6 / 6,3	20
TherMax 10/160 M6	045695	12	220	140 - 160	70	22	13	4,5 - 6,0 / M6 / 6,3	20
TherMax 10/180 M6	045696	12	240	160 - 180	70	22	13	4,5 - 6,0 / M6 / 6,3	20
TherMax 10/200 M6	512605	12	260	180 - 200	70	22	13	4,5 - 6,0 / M6 / 6,3	20
TherMax 10/220 M6	514250	12	280	200 - 220	70	22	13	4,5 - 6,0 / M6 / 6,3	20
TherMax 10/240 M6	514251	12	300	220 - 240	70	22	13	4,5 - 6,0 / M6 / 6,3	20
TherMax 10/100 M8	045697	12	160	80 - 100	70	22	13	M8	20
TherMax 10/120 M8	045698	12	180	100 - 120	70	22	13	M8	20
TherMax 10/140 M8	045699	12	200	120 - 140	70	22	13	M8	20
TherMax 10/160 M8	045700	12	220	140 - 160	70	22	13	M8	20
TherMax 10/180 M8	514252	12	240	160 - 180	70	22	13	M8	20
TherMax 10/200 M8	514253	12	260	180 - 200	70	22	13	M8	20
TherMax 10/220 M8	514254	12	280	200 - 220	70	22	13	M8	20
TherMax 10/240 M8	514255	12	300	220 - 240	70	22	13	M8	20
TherMax 10/100 M10	045702	12	160	80 - 100	70	22	13	M10	20
TherMax 10/120 M10	045703	12	180	100 - 120	70	22	13	M10	20
TherMax 10/140 M10	045704	12	200	120 - 140	70	22	13	M10	20
TherMax 10/160 M10	045705	12	220	140 - 160	70	22	13	M10	20
TherMax 10/180 M10	514256	12	240	160 - 180	70	22	13	M10	20
TherMax 10/200 M10	514257	12	260	180 - 200	70	22	13	M10	20
TherMax 10/220 M10	514258	12	280	200 - 220	70	22	13	M10	20
TherMax 10/240 M10	514259	12	300	220 - 240	70	22	13	M10	20

1) including SX 5

2) Min. screw length l_s = 22mm + thickness of mounting member t_{fix}; for use in wood without universal plug UX, consider drill hole diameter in footnote under load table.

Frame fixings/Stand-off installation

Stand-off installation TherMax 12/16

The approved stand-off installation with thermal barrier in external thermal insulation composite systems (ETICS)

Technical data



TherMax 12/110 M12



TherMax 16/170 M12

Item	Zinc-plated steel	Stainless steel	Approval	Contents	Sales unit
	Item No. gvz	Item No. R	DIBt		[pcs]
TherMax 12/110 M12	051291	—	●	20 TherMax M12, 20 perforated sleeves 20 x 130, 5 bits, 5 cutting blades, 5 user manuals	20
TherMax 12/110 M12 R	—	051537	●	10 TherMax M12 R, 10 perforated sleeves 20 x 130, 3 bits, 3 cutting blades, 3 user manuals	10
TherMax 12/110 M12 (2)	051290	—	●	2 TherMax M12, 2 perforated sleeves 20 x 130, 1 bit, 1 cutting blade, 1 user manual	1
TherMax 16/170 M12	051293	—	●	20 TherMax M16, 20 perforated sleeves 20 x 200, 5 bits, 5 cutting blades, 5 applicator tip extension hoses, 5 user manuals	20
TherMax 16/170 M12 R	—	051543	●	10 TherMax M16 R, 10 perforated sleeves 20 x 200, 3 bits, 3 cutting blades, 3 applicator tip extension hoses, 3 user manuals	10
TherMax 16/170 M12 (2)	051292	—	●	2 TherMax M16, 2 perforated sleeves 20 x 200, 1 bit, 1 cutting blade, 1 applicator tip extension hose, 1 user manual	1

Frame fixings/Stand-off installation

DuoPower

The duo of power and intelligence

Technical data



DuoPower



DuoPower with greater anchorage depth

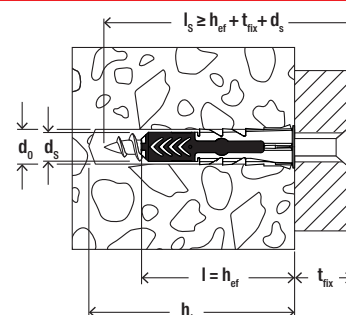

Item	without screw	with screw	Drill hole diameter d_0 [mm]	Min. drill hole depth h_1 [mm]	Min. panel thickness d_p [mm]	Min. bolt penetration $l_{E,min}$ [mm]	Anchor length l [mm]	Wood and chipboard screws $d_s / d_s \times l_s$ [mm]	Drive	Max. fixture thickness t_{fix} [mm]	Sales unit [pcs]
	Item No.	Item No.									
DuoPower 5 x 25	555005	—	5	35	12,5	29	25	3 - 4	—	—	100
DuoPower 6 x 30	555006	—	6	40	12,5	35	30	4 - 5	—	—	100
DuoPower 6 x 50	538240	—	6	60	12,5	55	50	4 - 5	—	—	100
DuoPower 8 x 40	555008	—	8	50	12,5	46	40	4,5 - 6	—	—	100
DuoPower 8 x 65	538241	—	8	75	2 x 12,5	71	65	4,5 - 6	—	—	50
DuoPower 10 x 50	555010	—	10	70	12,5	58	50	6 - 8	—	—	50
DuoPower 10 x 80	538242	—	10	100	—	88	80	6 - 8	—	—	25
DuoPower 12 x 60	538243	—	12	80	—	70	60	8 - 10	—	—	25
DuoPower 14 x 70	538244	—	14	90	—	82	70	10 - 12	—	—	20
DuoPower 5 x 25 S	—	555105	5	40	12,5	29	25	3,5 x 35	PZ2	6	50
DuoPower 6 x 30 S	—	555106	6	45	12,5	35	30	4,5 x 40	PZ2	5	50
DuoPower 6 x 50 S	—	538245	6	65	12,5	55	50	4,5 x 60	PZ2	5	50
DuoPower 8 x 40 S	—	555108	8	60	12,5	45	40	5 x 55	PZ2	15	50
DuoPower 8 x 65 S	—	538246	8	85	2 x 12,5	70	65	5 x 80	PZ2	10	25
DuoPower 10 x 50 S	—	555110	10	74	12,5	57	50	7 x 69	SW 13 / TX 40	13	25
DuoPower 10 x 80 S	—	538247	10	112	—	87	80	7 x 107	SW 13	20	10
DuoPower 12 x 60 S	—	538248	12	85	—	68	60	8 x 80	SW 13	12	10
DuoPower 14 x 70 S	—	538249	14	100	—	80	70	10 x 95	SW 17	15	8

Frame fixings/Stand-off installation

Universal plug UX

The nylon plug for all building materials

Technical data

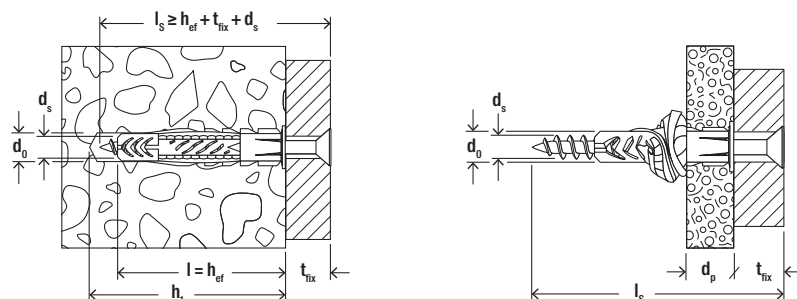
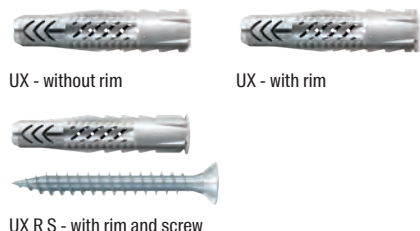

Item	Without rim	With rim	With rim and screw	Drill hole diameter	Min. drill hole depth	Min. panel thickness	Anchor length	Wood and chipboard screws	Max. fixture thickness	Sales unit
	Item No. UX	Item No. UX R	Item No. UX R S	d_0 [mm]	h_1 [mm]	d_p [mm]	l [mm]	$d_s / d_s \times l_s$ [mm]	t_{fix} [mm]	[pcs]
UX 5 x 30	094721	094722	—	5	40	9,5	30	3 - 4	—	100
UX 6 x 35	062754	062756	—	6	45	9,5	35	4 - 5	—	100
UX 6 x 35	—	—	094758	6	50	9,5	35	4,5 x 45	20	25
UX 6 x 50	072094	072095	—	6	60	9,5	50	4 - 5	—	100
UX 6 x 50	—	—	094759	6	65	9,5	50	4,5 x 60	5	25
UX 8 x 40	—	505483	—	8	50	9,5	40	4,5 - 6	—	100
UX 8 x 50	077869	077870	—	8	60	9,5	50	4,5 - 6	—	100
UX 8 x 50	—	—	094760	8	70	9,5	50	5 x 65	10	25
UX 8 x 50	—	—	094762	8	75	9,5	50	5 x 70	15	25
UX 10 x 60	077871	077872	—	10	75	12,5	60	6 - 8	—	50
UX 10 x 60	094761 ¹⁾	—	—	10	90	12,5	60	6 x 85	20	10
UX 12 x 70	062758	—	—	12	85	—	70	8 - 10	—	25
UX 14 x 75	062757	—	—	14	95	—	75	10 - 12	—	20

1) with screw

Frame fixings/Stand-off installation

Expansion plug SX

The powerful nylon plug with 4-way expansion

Technical data



Plug SX with rim



Plug SX - with greater anchorage depth, without rim



Plug SX S with rim and screw

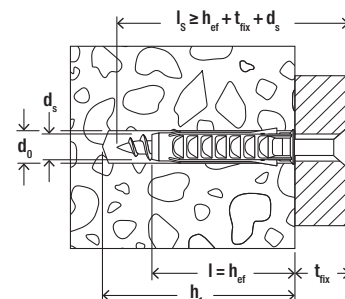

Item	With rim	With greater anchorage depth, without rim	With rim and screw	Drill hole diameter	Min. drill hole depth	Anchor length	Wood and chip-board screws	Max. fixture thickness	Sales unit
	Item No. SX	Item No. SX	Item No. SX-S	d ₀ [mm]	h ₁ [mm]	l [mm]	d _s / d _s x l _s [mm]	t _{fix} [mm]	[pcs]
SX 4 x 20	070004	—	—	4	25	20	2 - 3	—	200
SX 5 x 25	070005	—	—	5	35	25	3 - 4	—	100
SX 6 x 30	070006	—	—	6	40	30	4 - 5	—	100
SX 6 x 30	—	—	070021	6	45	30	4,5 x 40	5	50
SX 6 x 30 S PH TX	—	—	545839	6	40	30	4,5 x 40	—	100
SX 6 x 50	078185	024827	—	6	60	50	4 - 5	—	100
SX 8 x 40	070008	—	—	8	50	40	4,5 - 6	—	100
SX 8 x 40	—	—	070022	8	60	40	5 x 60	15	50
SX 8 x 65	—	024828	—	8	75	65	4,5 - 6	—	50
SX 10 x 50	070010	—	—	10	70	50	6 - 8	—	50
SX 10 x 80	—	024829	—	10	95	80	6 - 8	—	25
SX 12 x 60	070012	—	—	12	80	60	8 - 10	—	25
SX 14 x 70	070014	—	—	14	90	70	10 - 12	—	20
SX 16 x 80	070016	—	—	16	100	80	12 (1/2")	—	10

Foams and sealants

One-component gun foam

The gun foam with proven joint sound insulation

Technical data



PUP 750 B3

Item	Item No.	Content per can	Max. foam yield (free foaming)	Colour	Sales unit
		[ml]	[l]		[pcs]
PUP 750 B3 GunGrade (EN/FR)	098012 ¹⁾	750	41	beige	12

¹⁾ Dangerous goods - no express shipping possible.

Foams and sealants

2-component premium rapid foam

The high-quality 2-component rapid foam with high yield for secure fixing with pull activation

Technical data



2K PU 400 PLUS

Item	Item No.	Content per can	Max. foam yield (free foaming)	Sales unit
		[ml]	[l]	[pcs]
2K PU 400 (DE)	053081 ¹⁾	400	10	12

¹⁾ Dangerous goods - no express shipping possible.

Foams and sealants

One-component fast bonding foam

The high-quality rapid installation foam with resistance of water pressure for professionals

Technical data



PU 1/750 B3

Item	Item No.	Content per can	Max. foam yield (free foaming)	Colour	Sales unit
		[ml]	[l]		[pcs]
PU 1/750 B3 HandHeld (EN/FR)	098011 ¹⁾	750	41	beige	12
PU 750 B3 (EN/FR/AR)	050427 ¹⁾	750	41	beige	12

¹⁾ Dangerous goods - no express shipping possible.

Foams and sealants

Premium sanitary silicone DSSA

The high-quality premium sanitary silicone

8

Technical data



DSSA

Item	Item No.	Colour	Contents	Sales unit
			[ml]	[pcs]
DSSA TP (DE/EN)	053100	transparent	310	1
DSSA W (DE/EN)	053101	white	310	1
DSSA GR (DE/EN)	053102	grey	310	1
DSSA BG (DE/EN)	053103	bahama beige	310	1
DSSA DG (DE/EN)	053105	dark grey	310	1
DSSA SW (DE/EN)	053120	black	310	1
DSSA SG (DE/EN)	058530	silver grey	310	1
DSSA FUG (DE/EN)	512208	joint grey	310	1
DSSA SAG (DE/EN)	512209	sanitary grey	310	1
DSSA MA (DE/EN)	512210	manhattan	310	1
DSSA AN (DE/EN)	512211	anthracite	310	1

Foams and sealants

Premium construction silicone DBSA

The low-odour premium construction silicone with high adhesive spectrum for metal processors

Technical data



DBSA

Item	Item No.	Colour	Contents	Sales unit
			[ml]	[pcs]
DBSA TP (DE/EN)	053090	transparent	310	1
DBSA W (DE/EN)	053091	white	310	1
DBSA GR (DE/EN)	053092	concrete grey	310	1
DBSA SW (DE/EN)	053094	black	310	1
DBSA SLG (DE/EN)	512213	slate grey	310	1

Foams and sealants

Multi Adhesive & Sealant KD

Flexible adhesive and sealant for inside and outside with a high initial adhesion rate, even on damp substrates

Technical data



KD

KDC

Item	Item No.	Colour	Contents	Sales unit
			[ml]	[pcs]
KD WHITE 290ML	059389	white	290	1
KD GREY 290ML (DE/EN)	503318	grey	290	12
KD BLACK 290ML (DE/EN)	503319	black	290	12
KDC CRYSTAL CLEAR 290ML	503317	crystal clear	290	12

Foams and sealants

Premium all-weather sealant DDK

The permanently elastic joint sealant with a strong hold on all substrates

Technical data



DDK

Item	Item No.	Colour	Contents [ml]	Sales unit [pcs]
DDK TR (DE/EN)	049103	transparent	310	12

Foams and sealants

Flexible power adhesive premium HTM

Flexible high-performance adhesive with really high initial adhesion to many absorbent and non-absorbant substrates

Technical data

8



HTM

Item	Item No.	Colour	Contents [ml]	Sales unit [pcs]
HTM WH 290 (DE/EN)	541712	white	290	1

Foams and sealants

Zinc Spray FTC-ZS / FTC-ZA

Fast-drying surface and corrosion protection with outstanding long-term effects for metals. FTC-ZA is ideal for repairing damaged zinc coatings with colour-matched corrosion protection (RAL9006).

Technical data



FTC-ZS

FTC-ZA

Item	Item No.	Contents	Sales unit
		[ml]	[pcs]
FTC-ZS (EN/FR/ES/PT)	509242 ¹⁾	400	12
FTC-ZA (EN/FR/ES/PT)	509241 ¹⁾	400	12

¹⁾ Dangerous goods - no express shipping possible.

Foams and sealants

Accessories

Technical data



PUP K2 PLUS

PUP M3

PUP M4 BLACK

Item	Item No.	Sales unit
		[pcs]
PUP K2 PLUS	062400	1
PUP M3	033208	1
PUP M4 BLACK	513429	1

Technical data



PUR 500

Item	Item No.	Contents	Sales unit
		[ml]	[pcs]
PUR 500 (DE/EN)	053085 ¹⁾	500	1

¹⁾ Dangerous goods - no express shipping possible.

Technical data



KP M1

KP M3

FIS DM S

Item	Item No.	Sales unit
		[pcs]
KP M1	053115	1
KP M3	541441	1
FIS DM S	511118	1

Technical data



FIS DP S-XL

FIS DM S-L

FIS AC

Item	Item No.	Sales unit
		[pcs]
FIS DP S-XL	512401	1
FIS DM S-L	510992	1
FIS AC	096497	1

8

Technical data



AB G

Item	Item No.	Sales unit
		[pcs]
Blow-out pump AB G	089300	1

Accessories for drill hole cleaning





BS

Item	Item No.	Brush diameter	For drill diameter	Sales unit
		[mm]	[mm]	[pcs]
BS ø 8	078177	9	8	1
BS ø 10	078178	11	10	1
BS ø 12	078179	13	12	1
BS ø 14	078180	16	14	1
BS ø 16/18	078181	20	16/18	1
BS ø 24	078182	26	24	1
BS ø 28	078183	30	28	1
BS ø 30/32/35	078184	40	30/32/35	1



9

Fire protection system FireStop

Intumescent acoustic mastic FiAM	448	
Fire Collar FFC	450	
Foam Barrier System PLUS	452	

Intumescent Acoustic Mastic FiAM

Flexible fire resistant acoustic mastic

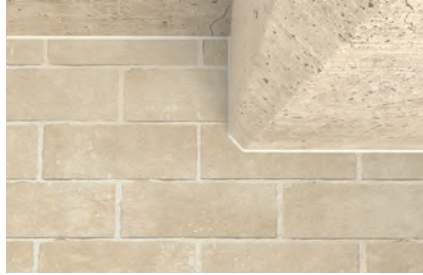

Construction joints



Non combustible services

Applications

- Metallic pipes: 6" (159 mm)
- Cable trays: 18" x 2" (450 x 50 mm)
- Cable bunches: 3" (80 mm)
- Linear joints: flexible and rigid construction elements
- Joints between FCPS coated panel system

Advantages

- Water based
- Low VOC
- Movement capability $\pm 25\%$
- Excellent acoustic properties
- Approved for infinite linear gap length
- Halogen and solvent free
- Paintable
- With excellent slump characteristics

Functioning

- FiAM is a one-part water-based acrylic emulsion.
- It has a fire resistance of up to 5 hours when used in construction joints and services in both vertical and horizontal applications.
- When exposed to fire, it reacts to form a highly insulative char that slows down heat transfer and provides a barrier to fire seal.
- It is suitably compatible in a variety of materials, and is utilised within the FCPS which is designed to seal large openings in fire rated floors and walls.

Assessment/Approval

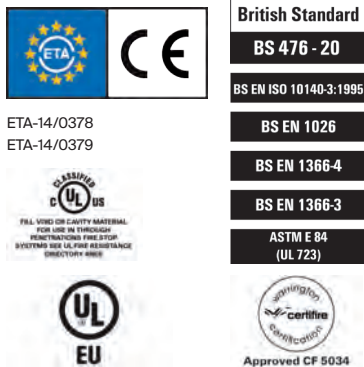

Building materials

- Flexible wall constructions
- Rigid floor and wall constructions
- Masonry
- Concrete
- Timber
- Steel
- FCPS System

Installation FIAM

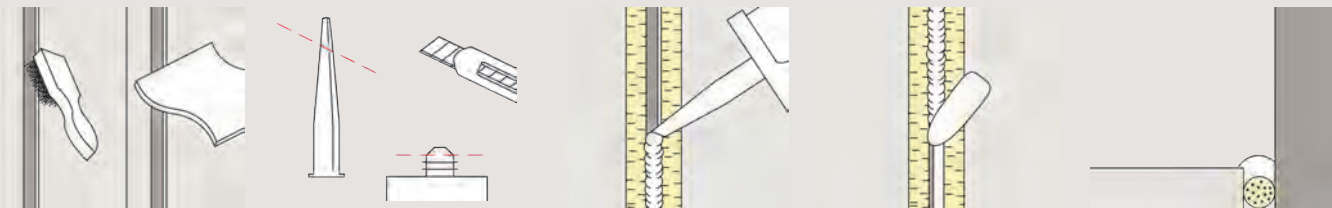

Installation

1. Clean all surfaces free from loose debris and contaminants and install required backing material.
2. Apply FiAM to required parameters as per approved system, making sure that it is in contact with all surfaces to provide maximum adhesion.
3. Tool sealant to a defect-free finish using a wetted trowel or putty knife.

Specifications

Item	Item No.	Languages on the cartridge	Contents [ml]	Suitable for use with	Sales unit [pcs]
FiAM 310	053011	DE, FR, EN, IT	310	—	25
FiAM 310	538152	DK, FI, SE, NO	310	—	25
FiAM 310	538150	TR, PT, ES, NL	310	—	25
FiAM 310	538151	PL, SK, CZ, HU	310	—	25
FiAM 600	056006	—	600	—	25
KP M2	053117	—	—	FiAM 310, FFRS 310, UFS 310, FiGM 310	1
Applicator gun 600 ml	097967	—	—	FiAM 600	1

Technical data

Chemical base	Water-based acrylic
Relative gravity	Approx 1.6 g/cm ³
Skin-forming time	Approx 10 minutes at 23 °C RH
Curing rate	Approx 1.5 mm per 24 hours*
Storage temperature	+5 °C to +25 °C
Movement capability	± 25 %
Slump	Nil up to 30 mm
Shelf-life	18 months (under recommended conditions)
pH Value	8 - 9.5
Sound transmission class (Rw partition and specimen)	63 dB
Yield per l/m	Depending on application
Colour	White, grey
European Technical Approval	ETA 14-0378, ETA 14-0379
CE marking	1121-CPR-JA5044

* Curing rate is dependent on substrate, air humidity and weather conditions.

9

Application data

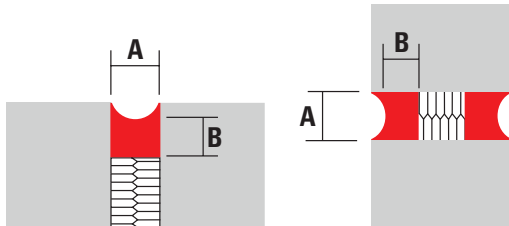
	Joint width A [mm]	Joint depth B [mm]	Yield per linear metres
	30	20	0.5
20	15	1	
15	8	1.25	
10	10	3	
6	6	4.25	

Substrate	Max. joint width [mm]	Fire ratings	
		Integrity rating [minutes]	Insulation rating [minutes]
Concrete/concrete	60	240	240 Thread
Brick/concrete	25	240	30
Steel/blockwork	50	300	90
Hardwood/blockwork	50	60	60
Softwood/blockwork	25	30	30
Drywall/concrete/head detail	20	120	120

Service type size		Fire ratings	
		Integrity rating [minutes]	Insulation rating* [minutes]
Copper/steel/metal pipes	14 - 159 mm diam.	Up to 120	Up to 90
Loaded cable tray	450 x 50 (tray) cables to 21 mm	Up to 120	Up to 90
Single/bunched cables	30 - 80 mm diam. cables	Up to 90	Up to 90

* Copper, steel and metal pipes with an insulation rating of up to 90 minutes are in conjunction with the Thermal Defense Wrap (TDW).

Fire Collar FFC

Collar for sealing a wide range of combustible pipes where passing through fire rated walls and floors



Floor applications



Wall applications

Applications

- Non-metallic pipes: like PVC, HDPE, MDPE, ABS of various sizes through fire rated walls and floor assemblies

Advantages

- Easy retrofit at any time
- Water resistant
- No minimum annular service required
- Pre-fixed attachment lugs
- Fold back tag for secure fixture around pipe

Functioning

- FFC is a powder coated cylindrical steel sleeve, which contains a heat reactive graphite-based intumescent material that expands during fire.
- Designed to be securely fitted around the pipe and held in position with a retaining bolt.
- Any gaps up to 10 mm around FFC should be backfilled with FiAM or larger annular space should be closed with FCPS or FFSC.

Assessment/Approval

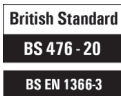

ETA-15/0696



Building materials

- Flexible and rigid wall constructions
- Solid concrete floors
- Hollow precast floors

Installation FFC

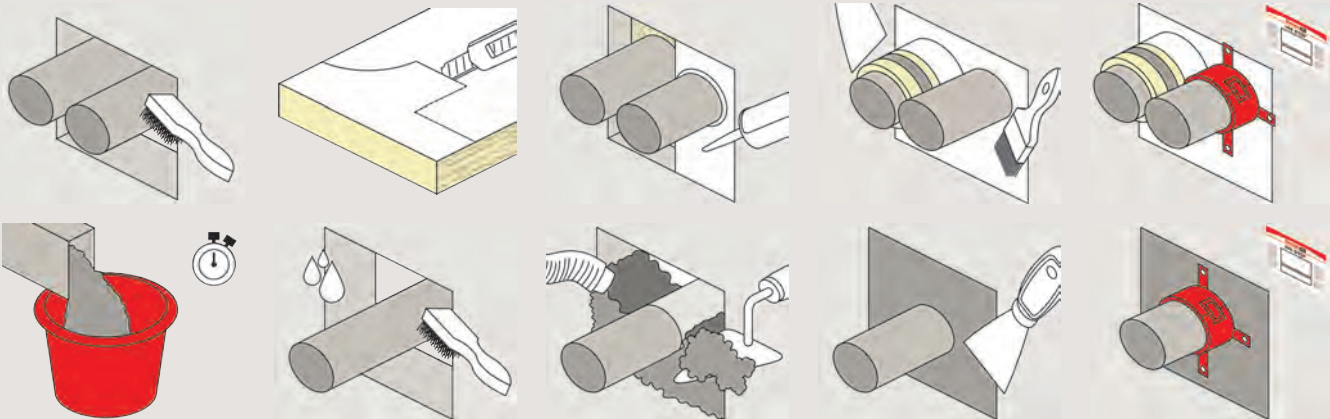

Installation

1. Clean all contact surfaces so they are free from loose debris and contaminants.
2. Ensure services are sufficiently supported as per approved system or local building codes.
3. Close the annular space as per requirement with FiAM, FCPS or FFSC and choose the correct size of FFC in accordance with the pipe diameter.
4. Open the toggle clip, place FFC around the pipe with its fixing lugs pointing towards the building element.
5. Lock the toggle clip and push it tightly against the surface of building element.
6. Attach the collar to the building element through the mounting lugs with a minimum anchoring depth of 32 mm and minimum 8 mm diameter fixing (please refer to fischer fire rated fixing section for correct anchor).
7. For vertical applications, repeat installation on both sides as per the instruction in the approved system.

Specifications

Item	Item No.	Dimensions	Sales unit
		B x L x H [mm / inch]	[pcs]
FFC 2/30-32	052456	30 - 32	1
FFC 2/38-40	052480	38 - 40	1
FFC 2/55	052481	55	1
FFC 2/63	052482	63	1
FFC 2/75	052483	75	1
FFC 2/82	052486	82	1
FFC 2/90	052487	90	1
FFC 2/110	052488	110	1
FFC 2/125	052489	125	1
FFC 2/160	052500	160	1
FFC 2/200	052501	200	1

Technical data

State	Solid
Colour	Red sleeve with black inner component
Odour	Odourless
Fire rating	Up to 4 hours
Available sizes	> 30 mm and max up to 200 mm
Significant expansion occurs at temperature	> 180 °C
Storage temperature	N/a
Shelf life	N/a

Foam Barrier System PLUS

FireStop Foam and FireStop Block for use in a System. Or individually. ETA approved and UL listed applications.

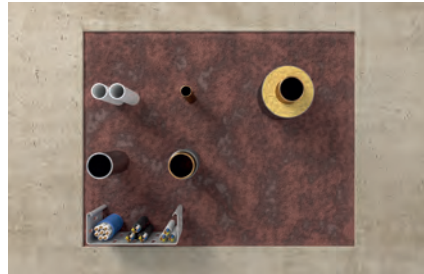

Mixed penetrations through wall or floor assembly



Cable tray through wall or floor assembly

Applications

- Metallic pipes up to 8 in. (203 mm)
- Insulated metallic pipes
- Conduits
- Cable and cable bunches
- Cable trays
- Mixed multiple penetrations

Assessment/Approval



ETA-17/0845

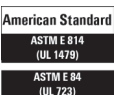

Advantages

- Easy access for difficult to reach openings
- Low VOC
- Various applications with two products only
- Age resistant
- Smoke resistant
- Resistant to damp
- Re-enterable and repairable
- Excellent adhesion
- No backing material required
- F-rating / E-rating up to 2 hours
- T-rating / I-rating up to 2 hours

Building materials

- Concrete (wall and floors)
- Masonry
- Flexible wall

Functioning

- FBS is a two component polyurethane expanding sound, smoke and firestopping seal for hard to reach locations which expands to up to 5 times of its volume.
- FBB are highly elastic mouldable blocks.
- FIB is a glass fiber reinforced intumescent wrap to enhance the insulation value of ETA applications.
- Tested in accordance with ASTM E 814 (UL 1479), ASTM E84 (UL 723) as well as EN 1366-3, EN 13501 the Barrier System PLUS allows an easy application which saves time and costs on site.

Installation Foam Barrier

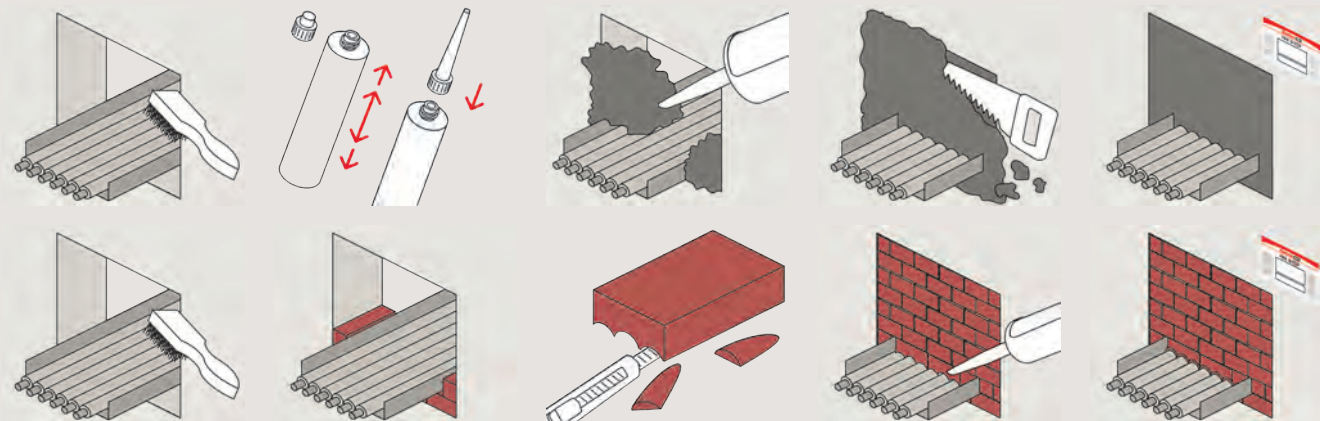

Installation

1. Clean all contact surfaces so they are free from loose debris and contaminants.
2. Install the required backing material as per the detailed instruction or approved system.
3. Unscrew cap from cartridge and insert into the dispensing gun.
4. Discard non-uniform initial material.
5. Fill the opening from back to front. Build up the foam from bottom to top.
6. After 2 minutes, tool foam to a defect-free finish using a suitable knife.
7. Cables or pipes that will be installed retroactively can be routed through the existing foam. Refill gaps due to removed cables or pipes with FBS foam.

Specifications

Item	Item No.	Languages on the cartridge	Contents [ml]	Dimensions	Sales unit
				D x s x L x B [mm]	[pcs]
FBS-UL	544079	—	380	—	6
FBB-UL FireStop Block	544083	—	—	200 mm x 130 mm x 60 mm	12
FBS-EN	544084	DE, FR, EN, IT	380	—	6
FBS-EN	544085	DK, FI, SE, NO	380	—	6
FBS-EN	544086	PL, SK, CZ, HU	380	—	6
FBS-EN	544087	TR, PT, ES, NL	380	—	6
FBB-EN FireStop Block	544088	—	—	200 mm x 144 mm x 60 mm	4
FIB Insulating Bandage	544089	—	—	5000 mm x 150 mm	1
FFBD Foam Barrier Dispenser	544090	—	—	—	1

Technical data

Criteria	FBS-UL	FBS-EN	FBB-UL	FBB-EN
Density		≥ 215 kg/m ³		240 kg/m ³ to 300 kg/m ³
Temperature resistance	≤ 80 °C	≤ 80 °C	≤ 80 °C	≤ 80 °C
Construction material class		B2 - as per DIN 4102		B2 - as per DIN 4102
Cartridge content	380 ml	380 ml		
Yield	≤ 1.9 l	≤ 2.1 l		
Cure time	Approx. 90 s	Approx. 90 s		
Colour	Red-brown	Red-brown	Red-brown	Red-brown
Pack size	Boxed in 6	Boxed in 6	Boxed in 4	Boxed in 18
Shelf life	12 months from date of manufacturing	12 months from date of manufacturing		
Storage Temperature	+5 °C to +30 °C	+5 °C to +30 °C		
Sound Transmission Class		43.5 dB - 66 dB		45.5 dB - 68 dB
Application Temp Range	+15 °C to +30 °C	+15 °C to +30 °C		

Application data - ETA

		Seal thickness 144 mm	Seal thickness 200 mm
Cable / Cable Trays and Ladders	Sheathed electrical cables up to 80 mm	Wall: E120 / EI60 - Floor: EI60	Wall / Floor: E120 / EI90
	Tied cable bundles up to 100mm		
	Non-sheathed electrical cables	Wall: E120 / EI45 - Floor: E60 / EI30	Wall/ Floor E120 / EI60
Conduits	Conduits / pipes of plastic up to a max. diameter of 40 mm	Wall: E120 / EI60 - Floor: E60 / EI30	Wall / Floor EI120
	Insulated metal pipes with max. diameter of 54 mm	Wall: E120 / EI90 - Floor: EI60	Wall / Floor E120 / EI90
Pipes	Non-insulated metal pipes with max. diameter of 28 mm	Wall: E120 / EI60 - Floor: EI60	Wall / Floor E120 / EI90
	Insulated metal pipes with AF/Armaflex insulation up to 88.9 mm diameter	Wall: E120 / EI90 - Floor: EI60	Wall / Floor EI120
	Combustible pipes with max. 50 mm diameter	Wall: EI120 - Floor: EI60	Wall / Floor EI120

For detailed information please refer to ETA 17/0845. Remaining space around penetrants can be filled with FBB FireStop Block.

Application data - UL

	Blank Opening	Metallic Pipes and Conduits	Cables / Cable Trays	Insulated Metal Pipes	Mixed Penetrations
Max. possible sizes of penetrants	Max 32 in. x 32 in. (813 x 813 mm)	Max 8 in. (203 mm) diameter	Max 24 in. (610 mm) wide by max 6 in. (152 mm) deep cable tray	Max 8 in. (203 mm) diameter with 1 in. (25 mm) insulation	See listed system
Barrier System PLUS UL	C-AJ-0158, W-L-0052	C-AJ-1669	C-AJ-3341; C-AJ-4110; W-L-4091	C-AJ-5383	C-AJ-8260; C-AJ-8261



10

Basics – good to know.

Maintenance groups for mounting pipe installations	458
Product solutions with examples	458
Elongation	460
Soundproofing	461
Corrosion protection	462
Fire protection	464
Mounting sprinkler systems	468
Mounting gas pipe	469
Seismic and dynamic	470
Dimension and weights of pipes	471
Important dimensions, variables and units	477
Approvals, markings and their importance	478

Maintenance groups and applications for mounting pipe installations.

The mounting of pipe installations, distribution systems and devices in various types of buildings, as well as industrial plants and processes are combined under the umbrella term, installation systems.

fischer Installation Systems is a complete range including the relevant supplementary products, in particular plugs and anchors.

The following belong to the maintenance groups which install pipes:

- Heating, ventilation and cooling systems
- Plumbing
- Sprinklers - extinguishing systems
- Electrical installations (medium and low voltage)
- Water and waste water treatment
- Energy and water supply

Through these maintenance groups, different pipe installations, which are offered by the Installation Systems product range, are created:

- Heating and cooling pipes
- Steam pipes
- Ventilation ducts and ventilation pipes
- Drinking water and service water pipes
- Waste water and drainage water pipes
- Sprinkler pipes
- Gas and compressed air pipes
- Medical gas supply
- Process pipes for gases and liquids
- Water and waste water treatment
- Energy and water supply

10

Product solutions with examples.

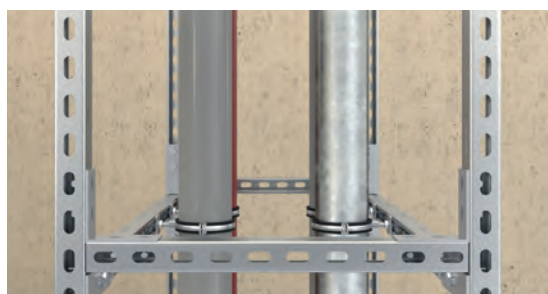

Installation shaft with FUS channel system

Through the distinctive interlocking of the channels for the channel nuts FCN Clix P or PFCN, the FUS channel system provides a secure grip for handling high shear loads.

Also the first choice for pipe line routes due to the greater stability.



Cantilevers for different load ranges

With centred load (load case 1), the load range of the brackets is between 0.33 kN (33 kg) and 7.5 kN (750 kg).

Lightweight cantilevers in the FLS system: ALK
 Medium cantilevers in the FUS system: FCA
 Massive cantilevers in the FUS system: FCAM

Product solutions with examples.



Pre-assembled construction element

The pre-assembled construction elements MW Clix 90° und SF Clix 31 guarantee for a time saving installation.

The time saving in comparison to usual U-profile file system is around 70%



Fix points and sliding components

Sound insulation requirements for fix points: FSFP anchor point

For all standard cases: FFPS fix point with FFPK Fixing ensures controlled movement in one direction: Sliding elements (see instructions on this under Elongation).

See chapter on anchors and sliding elements.

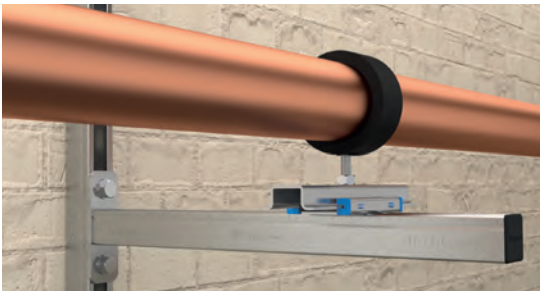

Refrigerant pipe clamp with integrated steel bracket

Different requirements for insulating layer thicknesses and the prevention of condensation are the basic requirements for a refrigerant pipe clamp.

The KFT refrigerant pipe clamp allows neat bonding for insulating layer thicknesses of up to 30 mm, 40 mm or 60 mm.



Sprinkler loop with VdS and FM approval

Sprinkler systems are created according to the requirements of property insurers. The association of property insurers, VdS and FM global, testing products and give approvals for installation in water extinguishing systems. The FRSL and FRSP sprinkler clamp are approved sprinkler loops.

See also Mounting sprinkler installations.



Channel connection - which loads are relevant?

In the design of supports or similar components for mounting pipe installations, the load of the connecting element, such as a hammer-head screw (e.g. FHS Clix S) or channel nut (e.g. FCN Clix P) is decisive for the connection with a angle bracket, for example. The load information is shown for one element, but can be doubled when using two elements. (see example left side).

Elongation.

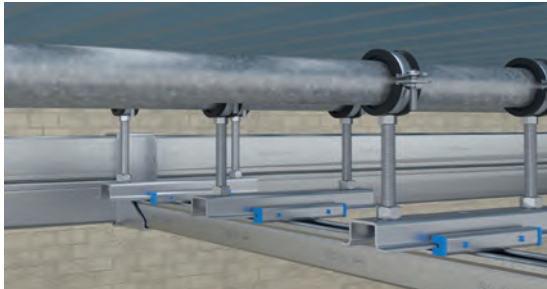

Materials expand with heat. For long components, the change in length is mainly considered. So it is not always a matter of expansion. Shrinkage upon cooling is to also be included in the calculation. This is important when installing pipes. Within piping, the change in length is to be specifically steered. Not doing this during installation results not only in pipe defects, but also in serious damage to components. It is therefore essential to determine how great the change in the length of a pipe can be.

For this purpose, the pipe length and the expansion coefficient of the pipe material, as well as the expected temperature difference, must be known. This is to be determined such that not only the normal operating temperatures, but also the maximum temperatures that can arise in a case of malfunction, are taken into account. The range is therefore from around 10 °C assembly temperature up to 95°C service temperature for water filled systems.

10

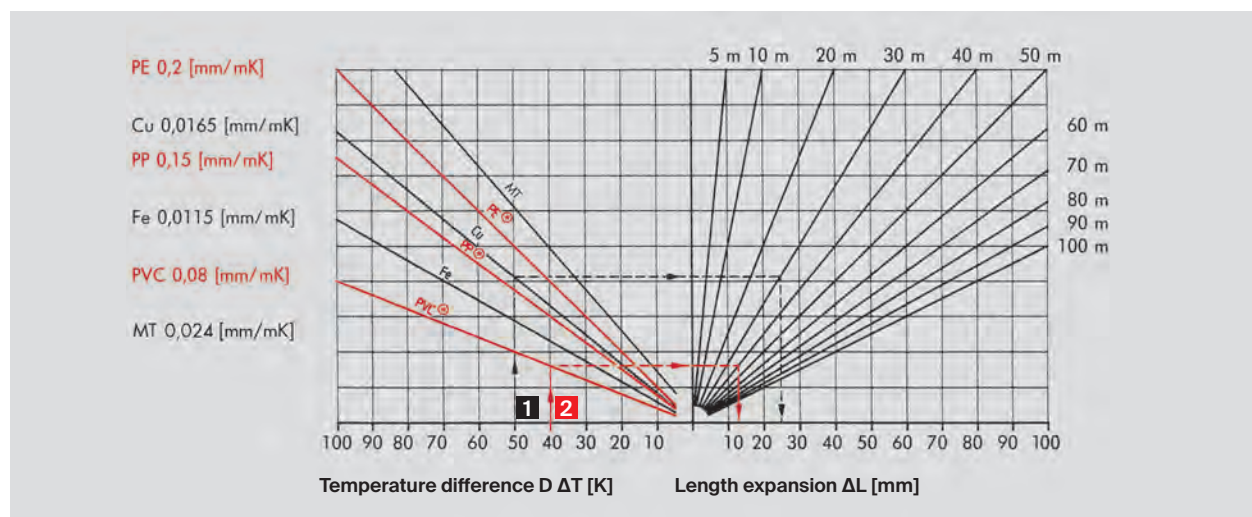

Note: For plastic pipes (PE, PP, PVC), the length expansion read from the diagram is to be multiplied by a factor of 10.

Example

1 Copper pipe, Cu – Length of pipe span 30 m
 Temperature difference $\Delta T = 50$ K
 Length expansion $\Delta L = 24,75$ mm

2 PVC pipe – Length of pipe span $L = 40$ m
 Temperature difference $\Delta T = 40$ K
 Length expansion $\Delta L = 128$ mm (table value x10)

Length expansion calculation formula

$$\Delta L = L \times \Delta T \times \alpha$$

[mm] [m] [K] [mm/m K]

ΔL = Change in length
 L = Length of the pipe span/section
 ΔT = Temperature difference
 α = Length expansion coefficient

Soundproofing.



As defined in the appropriate standards, the goal of soundproofing is to reduce the transmission to other apartments or usage areas to a given noise range. The upper limits for permissible residual noise levels are defined in the standards.

Soundproofing - VDI 4100

In principle, the VDI 4100 values are, among other things, protection against noise from building systems that are mounted in the neighbouring area. According to VDI 4100, living areas are rooms that are in need of protection; in apartments, these are all rooms with a floor space of > 8m². This includes kitchens, bathrooms, toilets, hallways and ancillary rooms. VDI 4100 further recommends agreeing with the contracted companies the sound insulation values SSt EB I = 35 dB or SSt EB II = 30 dB for noise emerging from one's own area. Exceptions to this are all sounds that are influenced by the residents, i.e. self-installed air conditioners in the apartment or noises from flushing toilets, etc.

Soundproofing - DIN 4109

The DIN 4109 from 2016-07 still supplemented by A1 (2001-01), in which the permissible sound pressure level in living and sleeping areas for noise from building installations was reduced from 35 to 30 dB(A). The standard is not applicable to the protection against noise from building installations in one's own living area, but only to sounds coming from "external" areas as defined in VDI4100. For increased sound insulation, DIN 4109 Addendum 2 (from 1989) specifies a reduction in the permissible values by 5 dB(A) (to 25 dB(A)) as effective for noises from building installations.

Soundproofing - important influential factors for pipe mounting

Sound propagates in vibrations. These sound waves can propagate in solid, liquid and gaseous media, where the speed of this sound propagation differs greatly in the various media. So the sound in pipe installations is primarily forwarded through the pipeline itself and not through the carried medium.

Transmission over the metal pipe is faster than in water, for example. In welded heating systems, for example, the individual sounds of striking a pipe can propagate throughout the entire building. The sound waves are transmitted in a medium in that the molecules constantly jolt one another, thereby transmitting the wave. Steel pipes or metallic mounting elements have an ordered metallic lattice, wherein forwarding is faster and with less loss than in amorphous materials, such as rubber (general elastomers). It can thus be determined that an inversely proportional relationship exists between the speed of sound [symbol; c] and the insulating behaviour of materials. That is, materials with a low sound speed always have better insulating properties than materials with a high sound speed (steel c = 5100 m/s). Rubber (c ~40 m/s) is therefore eminently suitable for sound insulation.

In rubber, the sound waves stop dead, so to speak, wherein the energy is converted into heat.

Therefore, the sound isolation must in principle occur between the pipes and the structure. Here, we recommend the installation of a sound insulating element as close to the sound source as possible; in the simplest case, with an insulating insert in the pipe clamp itself. Sound tested pipe clamps by fischer FRS Plus pipe clamp, FRS pipe clamp and FRS-L Universal pipe clamp.

Corrosion protection.

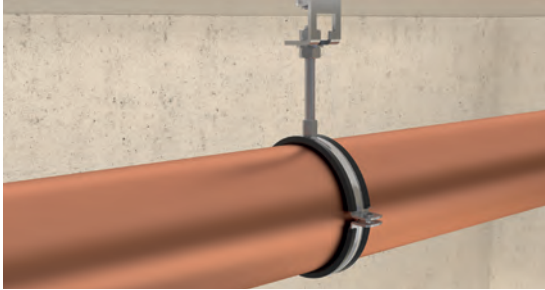

In most cases, pipes and supply lines are installed in dry rooms. Therefore, in addition to corrosion resistant materials, such as plastics or stainless steel and copper, the steel products used for installation systems are galvanised. A zinc coating thickness of 5-8 μm by means of electrolytic process (galvanising) is standard. For mounting rails, Sendzimir galvanised material is mainly used. Sendzimir galvanising is a method in which the material is drawn through a molten zinc bath, thereby achieving a zinc layer thickness of 12-20 μm . This method is used when there is no more welding for the subsequent processing. This is the case for mounting rails because they are cold-formed after galvanising.

By cutting and stamping the holes, the surface in this area is not completely covered by a protective layer. Punched mounting rails are therefore only recommended for the dry interior rooms.

For cantilever brackets, non-galvanised channel pieces are used which are welded to the base plate. Following completion, the entire component is galvanised, creating a zinc coating thickness of 5-8 μm .

Threaded parts are either galvanised or made of stainless steel. Hot dip galvanising is less suitable for this because the large zinc layer thickness of 40-150 μm severely impairs the thread engagement.

If installation systems are installed outdoors or in wet interior rooms, they must be made of either hot dip galvanised steel or stainless steel.

Hot dip galvanising is very well suited to the protection of steel. The corrosion process is thus 10 times slower than with galvanising. The zinc loss depends on the surrounding atmosphere and humidity. An annual zinc reduction of 1-10 μm can, however, be assumed. The layer thickness is therefore crucial to the durability of the material.

Crucial here are the environmental influences under which the systems are installed. An overview of the expected impact on the protective action can be seen in the following diagram and tables.

Hot-dip galvanized steel

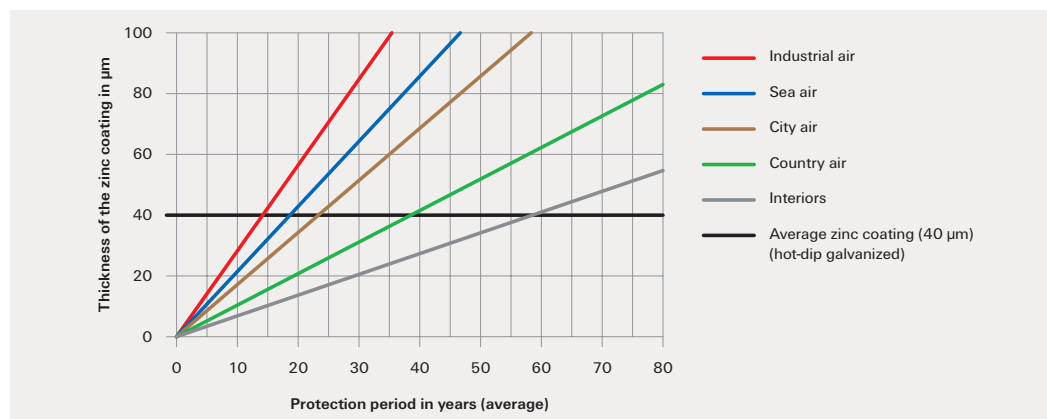

Stainless steel						
Steel Grade					Corrosion	
Material No.	Short Name	AISI	UNS	Designation of the Steel Group with	Resistance Class	Exposure and Typical Applications
1.4305	X8CrNiS18-9	303	S 30300	A1	I/light	Indoor climate except damp location.
1.4301	X5CrNi18-10	304	S 30400	A2	II/moderate	Accessible constructions without nameable content of chlorides or sulfur dioxide, except industrial atmosphere.
1.4307	X2CrNi 18-9	304L	S 30403	A2L	II/moderate	Accessible constructions without nameable content of chlorides or sulfur dioxide, except industrial atmosphere.
1.4362	X2CrNiN23-4	324	S32304	A4	III/medium	Constructions with moderate chloride and sulfur dioxide exposure and inaccessible constructions.
1.4401	X5CrNiMo17-12-2	316	S 31600	A4	III/medium	Constructions with moderate chloride and sulfur dioxide exposure and inaccessible constructions.
1.4404	X2CrNiMo17-12-2	316 L	S 31603	A4L	III/medium	Constructions with moderate chloride and sulfur dioxide exposure and inaccessible constructions.
1.4571	X6CrNiMoTi17-12-2	316 Ti	S 31635	A5	III/medium	Constructions with moderate chloride and sulfur dioxide exposure and inaccessible constructions.
1.4529	X1NiCrMo-CuN25-20-7	-	N 08926	1.4529	IV/strong	High corrosion exposure due to chlorine, chloride and/or sulfur dioxide, high humidity as well as accumulation of hazardous substances.

Fire protection.



Fire protection in pipe installations according to the latest standards

- Fire-proof installations for individual pipes and pipe routes from R30 - R120 or F30 to F120.
- Proof of compliance with the criteria of MLAR (German standard pipe system directive) for installation in escape and rescue routes

Fire protection - protection goals

Firstly, fire protection serves to protect people, and is regulated by the building laws in the respective countries (or regional states). Secondly, fire protection serves to protect property and this is regulated by the insurance associations, such as VdS and FM. These requirements partially go beyond the building legislation. This is particularly evident in the installation of fire protection systems, such as sprinklers, etc., as approved or recognised components must be used here. (See the following section for further details on this)

Fire inspection reports for the mounting of pipe clamps and mounting rails

Fire safety inspection reports meet the requirements for fire protection according to the building regulations of the countries and, especially for Germany, according to the nationwide homonymic German pipe systems directive (LAR), based on the standard pipe systems directive of 2005 (MLAR 2005). Personal protection is defined in the MLAR Directive through clear rules for escape routes, such as corridors, stairwells and hallways between stairwells and the exit.

The key message is to ensure the safety of the escape route by ensuring the functioning of the fire-proof sub-ceiling. To this end, compliance with the minimum distance of $\min a \leq 50 \text{ mm}$ according to MLAR is required between installations and underlying suspended fire-proof F30 sub-ceilings (fire resistance of 30 minutes). Based on the fire inspections, load information for a fire resistance of 30 minutes in relation to the maximum

Permissible deformation of mounting rails or pipe clamps, for example, was determined. The necessity for these considerations arises from the properties of the steel, which at 30 minutes is subjected to a temperature of $>800 \text{ }^\circ\text{C}$ according to the standard temperature curve (ISO curve).

Reduction factors k_θ

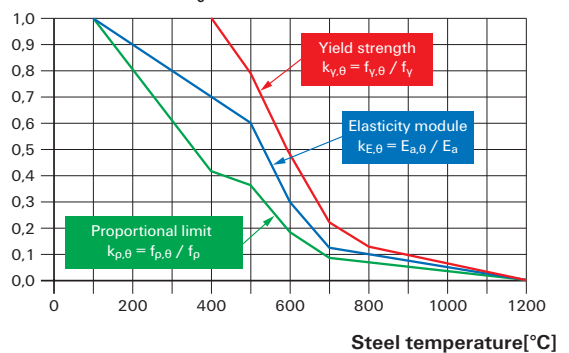

Dependency of the yield strength, proportional limit and elasticity module on the temperature (basis: EN1993-1-2:2012-12 Eurocode 3).

Additionally, the same information is documented in the inspection reports for a fire resistance rating of R30, R60, R90 and R120 according to EN1363-1 and DIN4102-2. (see following load tables)

Product overview with proof in inspection reports and supplementary sheets.

Product	Document no.	MLAR	R30 – R120	F30 – F120
FRS	MFPA Leipzig - GS 3.2/14-175-2	ja	ja	
FUS/ FCA	MFPA Leipzig - GS 3.2/14-175-4	ja	ja	
FRS- LUni- versal	MFPA Leipzig - GS 3.2/18-120-2	ja	ja	
FLS/ ALK	MFPA Leipzig - GS 3.2/15-141-4	ja	ja	
SB	MPA-NRW – 210005109-7			ja
SBS	MPA-NRW – 210005109-4	ja		ja
PDH-K	MPA-NRW – 210005109-6	ja		ja

Load tables based on fire protection inspection reports.

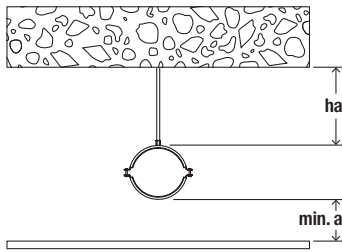

Pipe clamp FRS
 Load table based on the Advisory Opinion No. GS 3.2/14-175-2
 The following figures are valid for all FRS pipe clamps, galvanized, hdg and stainless steel.

FRS M8/M10 Threaded rods ≥ 4.8	MLAR strain	F-resistance 30	Maximale Lasten				
			Max. strain	Fire resistance time [minute]			
Clamping range	min a		min a	30	60	90	120
[mm]	[mm]	[kN]	[mm]	[kN]	[kN]	[kN]	[kN]
12-67	≤ 250	≤ 50	51	0,56	0,29	0,20	0,15
	≤ 500	≤ 50	54	0,56	0,29	0,20	0,15
	≤ 750	≤ 50	57	0,56	0,29	0,20	0,15
	≤ 1000	≤ 50	60	0,56	0,29	0,20	0,15
72-92	≤ 250	≤ 50	50	0,79	0,49	0,36	0,29
	≤ 500	≤ 50	53	0,79	0,49	0,36	0,29
	≤ 750	≤ 50	56	0,79	0,49	0,36	0,29
	≤ 1000	≤ 50	59	0,79	0,49	0,36	0,29
108-116	≤ 250	≤ 50	61	0,63	0,39	0,29	0,23
	≤ 500	≤ 50	64	0,63	0,39	0,29	0,23
	≤ 750	≤ 50	66	0,63	0,39	0,29	0,23
	≤ 1000	≤ 50	69	0,63	0,39	0,29	0,23
121-168	≤ 250	≤ 50	61	1,00	0,51	0,34	0,25
	≤ 500	≤ 50	63	1,00	0,51	0,34	0,25
	≤ 750	≤ 50	66	1,00	0,51	0,34	0,25
	≤ 1000	≤ 50	69	1,00	0,51	0,34	0,25

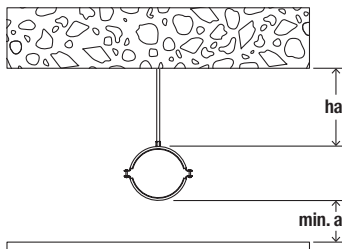

Pipe clamp FRS-L Universal
 Load table based on the Advisory Opinion No. GS 3.2/18-120-2
 The following figures are valid for all FRS-L Universal pipe clamps, galvanized, hdg and stainless steel

FRS-L Universal M8/M10 Threaded rods ≥ 4.8	MLAR -Loads strain	F-resistance	Max. Loads				
			Max. strain	Fire resistance time [minute]			
Clamping range	min a	30	min a	30	60	90	120
[mm]	[mm]	[kN]	[mm]	[kN]	[kN]	[kN]	[kN]
8-37	≤ 250	≤ 50	54	0,27	0,14	0,09	0,07
	≤ 500	≤ 50	57	0,27	0,14	0,09	0,07
	≤ 750	≤ 50	60	0,27	0,14	0,09	0,07
	≤ 1000	≤ 50	62	0,27	0,14	0,09	0,07
38-66	≤ 250	≤ 50	72	0,29	0,14	0,09	0,06
	≤ 500	≤ 50	75	0,29	0,14	0,09	0,06
	≤ 750	≤ 50	78	0,29	0,14	0,09	0,06
	≤ 1000	≤ 50	80	0,29	0,14	0,09	0,06
67-119	≤ 250	≤ 50	75	0,53	0,35	0,27	0,22
	≤ 500	≤ 50	78	0,53	0,35	0,27	0,22
	≤ 750	≤ 50	81	0,53	0,35	0,27	0,22
	≤ 1000	≤ 50	83	0,53	0,35	0,27	0,22
120-72	≤ 250	≤ 50	65	0,42	0,31	0,25	0,22
	≤ 500	≤ 50	68	0,42	0,31	0,25	0,22
	≤ 750	≤ 50	72	0,42	0,31	0,25	0,22
	≤ 1000	≤ 50	75	0,42	0,31	0,25	0,22

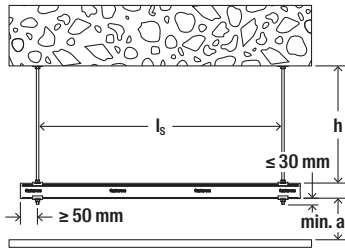

Picture 1

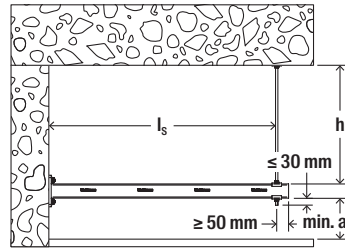

Picture 3

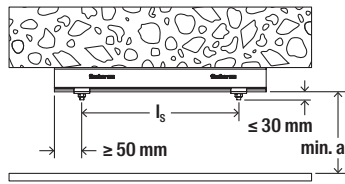

Picture 2

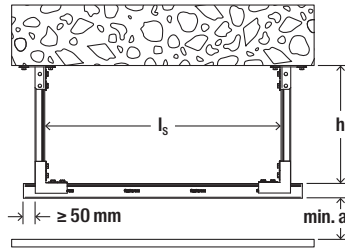

Picture 4

Note: Picture 1 - 3 are valid for FUS/
FCA and FLS/ALK load tables

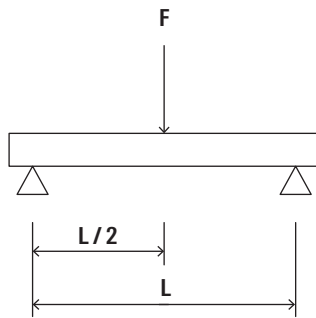

Point load
Spot load, e.g. a
pipeclamp on the rail.

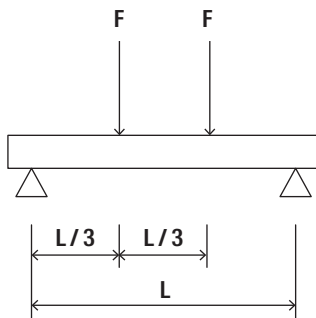

Uniform load
Uniform distribution
of load on the rails,
e.g. bend-proof
ventilation duct.

$$F = q \times L$$

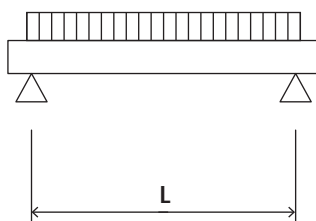

Multiple load
More than one load
point on the rail,
e.g. several pipe
clamps.

FUS-Channel / FCA-Cantilever arm								
Load table based on the Advisory Opinion No. GS 3.2/14-175-4								
The following figures are valid for FUS channels and FCA cantilever arms, galvanized, hdg and stainless steel.								
FUS/FCA 41/2,5 (Picture 1-3)		MLAR loads		Max. Loads				
Load case	Is [mm]	strain	F-resistance	Max. strain min a ²⁾ [mm]	Fire resistance time [minute]			
		min a ¹⁾ [mm]	30 [kN]		30 [kN]	60 [kN]	90 [kN]	120 [kN]
Point load	≤ 400	≤ 50	0,90	278	2,40	1,33	0,92	0,72
	≤ 700	≤ 50	-	320	1,61	1,04	0,80	0,67
Multiple load ³⁾	≤ 400	≤ 50	0,90	278	2,40	1,33	0,92	0,72
	≤ 700	≤ 50	-	320	1,61	1,04	0,80	0,67
Uniformly distributed load	≤ 400	≤ 50	1,50	258	3,00	2,10	1,41	1,06
	≤ 700	≤ 50	0,60	299	2,44	1,57	1,21	1,00
	≤ 1250	≤ 50	-	468	3,29	1,81	1,27	0,98
FUS/FCA 62/2,5 (Picture 1-3)		MLAR loads		Max. Loads				
Load case	Is [mm]	strain	F-resistance	Max. strain min a ²⁾ [mm]	Fire resistance time [minute]			
		min a ¹⁾ [mm]	Min. 30 [kN]		30 [kN]	60 [kN]	90 [kN]	120 [kN]
Point load	≤ 400	≤ 50	1,76	25	1,76	1,06	0,78	0,62
	≤ 1000	≤ 50	-	460	2,27	1,31	0,93	0,72
Multiple load ³⁾	≤ 400	≤ 50	1,76	25	1,76	1,06	0,78	0,62
	≤ 960 ⁴⁾	≤ 50	4,30	550	4,30	2,14	1,39	1,01
	≤ 1000	≤ 50	0,55	661	2,52	1,60	1,21	0,99
Uniformly distributed load	≤ 400	≤ 50	1,76	25	1,76	1,06	0,78	0,62
	≤ 960 ⁴⁾	≤ 50	4,30	550	4,30	2,14	1,39	1,01
	≤ 1000	≤ 50	0,55	661	2,52	1,60	1,21	0,99
	≤ 1250	≤ 50	0,50	592	2,41	1,65	1,31	1,11
FUS 62/2,5 (Picture 4)		MLAR loads		Max. Loads				
Load case	Is [mm]	strain	F-resistance	Max. strain min a ²⁾ [mm]	Fire resistance time [minute]			
		min a ¹⁾ [mm]	30 [kN]		30 [kN]	60 [kN]	90 [kN]	120 [kN]
Point load	≤ 1000	≤ 50	0,57	369	1,33	0,87	0,68	0,57
Multiple load ³⁾	≤ 1000	≤ 50	0,62	649	1,92	1,34	1,08	0,92
	≤ 1000	≤ 50	0,62	649	1,92	1,34	1,08	0,92

- 1) Valid for a suspension height $h_a \geq 500$ mm
- 2) Based on suspension height $h_a = 250$ mm, Expansion length of threaded rods in case of fire ~ 10mm/m
- 3) Given load values apply for multiple loads as summated point loads symmetrical allocated
- 4) This values are valid for FCA 62/2,5 with additional support by threaded rod

FLS-Channel / ALK-Cantilever arm								
Load table based on the Advisory Opinion No. GS 3.2/15-141-4								
The following figures are valid for FLS channels and ALK cantilever arms, galvanized, hdg and stainless steel.								
FLS/ALK 37/1,2 (Picture 1-3)		MLAR loads		Max. Loads				
Load case	Is [mm]	strain	F-resistance	Max. strain min a [mm]	Fire resistance time [minute]			
		min a [mm]	Min. 30 [kN]		30 [kN]	60 [kN]	90 [kN]	120 [kN]
Point load	≤ 400 ¹⁾	≤ 50	0,24	93	0,24	0,13	0,10	0,09
	≤ 400 ²⁾	≤ 50	0,09	289	0,47	0,38	0,33	0,30
	≤ 400 ⁴⁾	≤ 50	0,32	226	1,33	0,78	0,53	0,40
Multiple load ³⁾	≤ 400 ¹⁾	≤ 50	0,72	93	0,72	0,38	0,30	0,27
	≤ 400 ²⁾	≤ 50	0,26	289	1,42	1,13	0,99	0,90
	≤ 400 ⁴⁾	≤ 50	0,81	226	1,33	0,78	0,53	0,40
Uniformly distributed load	≤ 400 ¹⁾	≤ 50	0,72	93	0,72	0,38	0,30	0,27
	≤ 400 ²⁾	≤ 50	0,35	308	1,37	1,19	1,06	0,95
	≤ 400 ⁴⁾	≤ 50	0,81	226	1,33	0,78	0,53	0,40

- 1) Valid for a suspension height $h_a = 0$ mm, s. picture 2
- 2) Valid for a suspension height $h_a = 500$ mm, s. picture 1 (Expansion length of threaded rods in case of fire ~ 10 mm/m)
- 3) Given load values apply for multiple loads as summated point loads symmetrical allocated
- 4) This values are valid for ALK 37-450 with additional support by threaded rod, s picture 3 ($h_a = 500$ mm)

Mounting sprinkler systems.



Sprinkler systems are usually created according to different standards. For example, according to the VdS standard (VdS CEA 4001), the American FM standard 1951 (Factory Mutual Insurance Company" (FM Global)), UL 203 (Underwriters Laboratories (UL)), NFPA 13 regulations (National Fire Protection Association (NFPA)) or EN 12845.

The European Directive CEA 4001 was created in 1995 by the insurance industry in cooperation with the manufacturers' association EUROFEU, and VdS CEA 4001 was created in Germany in 2003 by the "Association of Property Insurers" (VdS).

EN 12845 was developed on the basis of CEA 4001 from 1995 and the VdS CEA 4001 from 2003, creating a standard that was practically the same word for word. National practices, such as those for Germany, are to be included in a revised DIN 14489 as a national annex to EN 12845.

The American rules correspond to the requirements for mounting pipe installations, but they must be checked in detail in each case.

For mounting sprinkler pipes, the different load values, mounting distances and connection sizes for pipe loops and pipe clamps, which are listed in the following table for the most common directives, are applicable.

10

Load values, fixing distances and connection sizes for pipe loops and pipe clamps for the most common guidelines

Pipe sizes DN	FM1951				NFPA13				VdS CEA 4001			
	Test load distance	Max. distance Min. rod size	Min. rod size [metric] [inch]		Test load calcu- lated [kN]	Max. distance [m]	Min. rod size [metric] [inch]		Loading capacity [kN]	Max. [m]	Min. Thread size [metric] [inch]	
15	-	-	-	-	1.4	3.60	9.5	3/8	2.0	4.00	M8	-
20	1.512	3.6	M10	3/8	1.5	3.60	9.5	3/8	2.0	4.00	M8	-
25	1.824	3.6	M10	3/8	1.7	3.66	9.5	3/8	2.0	4.00	M8	-
32	1.913	3.6	M10	3/8	1.9	3.66	9.5	3/8	2.0	4.00	M8	-
40	2.313	4.6	M10	3/8	2.4	4.57	9.5	3/8	2.0	4.00	M8	-
50	2.825	4.6	M10	3/8	2.9	4.57	9.5	3/8	3.5	4.00	M10	-
65	4.181	4.6	M10	3/8	3.8	4.57	9.5	3/8	3.5	6.00	M10	-
80	4.715	4.6	M10	3/8	4.8	4.57	9.5	3/8	3.5	6.00	M10	-
90	5.583	4.6	M10	3/8	5.7	4.57	9.5	3/8	3.5	6.00	M10	-
100	6.561	4.6	M10	3/8	6.7	4.57	9.5	3/8	5.0	6.00	M10	-
125	8.896	4.6	M12	1/2	9.0	4.57	12.7	1/2	5.0	6.00	M12	-
150	11.632	4.6	M12	1/2	11.8	4.57	12.7	1/2	8.5	6.00	M12	-
200	16.903	4.6	M12	1/2	18.2	4.57	12.7	1/2	8.5	6.00	M16	-
250	26.044	4.6	M16	5/8	26.7	4.60	15.9	5/8	-	6.00	-	-
300	35.141	4.6	M16	5/8	36.0	4.60	15.9	5/8	-	6.00	-	-
350	-	-	-	-	42.9	4.60	-	-	-	6.00	-	-
400	-	-	-	-	55.7	4.60	-	-	-	6.00	-	-
450	-	-	-	-	70.1	4.60	-	-	-	6.00	-	-
500	-	-	-	-	84.4	4.60	-	-	-	6.00	-	-

Mounting gas pipe.



A specification for the usable anchors emerged from the DVGW-TRGI revision in 2008. This is regulated in TRGI 2008 in Chapter II under item 5.3 "Preparation of pipe installations". In the TRGI from 2008, plastic anchors are now explicitly allowed under certain conditions.

The basis in the previous TRGI was the determination that gas pipes need to be mounted in the way that there are no free pipe cross-sections in the event of fire. In the new version, this was amended in that, in the event of fire, there may be no free pipe cross-sections up to a temperature of 650 °C. For pipe connections, this means that the axial restraint was also specified, and a brazed pipe joint, for example, is not considered as an axial restraint. Thus, standard commercially available plastic anchors with non-combustible pipe supports may be used for mounting metal inner pipes with an axial restraint of >650 °C. It should be noted that attachments are made to components with sufficient strength according to TRGI 2008. In addition, the mounting distances are governed in TRGI 2008, and are mandatory.

According to DVGW-TRGI 2008, plastic pipes for indoor pipes with an operating pressure up to 100 mbar are also allowed for the first time. For laying plastic inner pipes, in comparison to metal and non-combustible pipe installations, plastic pipes for gas installations are, without exception, subject to the system engagement of the manufacturer.

The fixing materials for open gas pipes can also be made of plastic if the static requirements are met. The requirement for using plastic pipes in gas installations is the installation of a type K gas flow monitor in conjunction with an additional thermally activated shut-off device (TAE), as the destruction of the openly laid plastic gas pipes in the event of fire must be assumed.

Integration of rules regarding building classes according to the German model building regulations

(MBO) was also implemented in DVGW TRGI 2008. An alignment of the fire protection requirements, which are specified in the German standard pipe systems directive (MLAR 2005) for the installation of pipes in buildings was, therefore, only logical. The limit for increased demands on the gas installation according to TRGI 2008 are > 2 utilisation units (building class 3) for buildings and for a floor level upper edge of more than 7m of the top floor (building class 4).

If any of these conditions exists, or if any of them are exceeded, it is not possible to lay plastic pipes in escape routes. For metal pipes, the requirements of MLAR 2005 for laying in installation channels or below plaster and plaster base are applicable. For pipe mounting with anchors, MLAR 2005 stipulates that either officially approved anchors are used or, alternatively, that the provisions of DIN4102-T.4, section 8.5.7.5 (or DIN EN 1366-1, section 13.6) are observed. The same rule also applies to the installation of pipes through officially approved partitions in walls and ceilings, as the mechanical destruction of the partitions by pipes in the event of fire must be prevented.

When installing gas pipes, we therefore recommend the use of approved metal anchors, since, through the general official approval and the European technical approval, the certificate of suitability for the anchor is provided, also for in the event of fire. This gives the installer the necessary safety, also at the limits.

Seismic and dynamic.



The seismic and dynamic requirements for non-structural installations, such as pipe installations, are often underestimated in comparison to those of structural installations. But even here, the rule is that the weakest link in the chain can lead to failure or to damage.

Since basically every building in which such requirements, or additional requirements included by property insurers, such as FM, are different, it is also not possible to specify standard details. In addition, the solutions to be developed should also include the links to the components.

For this reason, we recommend everyone to use the support of our technical staff, in order to develop a suitable and project-specific solution.

www.fischer-international.com

Dimension and weights of pipes, ventilation ducts and ventilation pipes.

Boiler pipe acc. to DIN 2448 / DIN EN 10220

DN	Size	Pipe outer- ϕ [mm]	Pipe weight empty [kg/m]	Pipe weight waterfilled [kg/m]	Pipe weight waterfilled + insulated ¹⁾ [kg/m]	Support widths [m]
8	1/4"	13.5	0.5	0.6	1.4	2.00
10	3/8"	17.2	0.7	0.8	1.9	2.25
15	1/2"	21.3	1.0	1.2	2.2	2.75
		25.0	1.1	1.5	2.8	2.75
20	3/4"	26.9	1.4	1.8	3.1	3.00
		30.0	1.8	2.3	4.0	3.00
		31.8	1.9	2.4	4.2	3.00
25	1"	33.7	2.0	2.6	4.7	3.50
		38.0	2.3	3.1	5.2	3.50
32	1 1/4"	42.4	2.6	3.7	5.7	3.75
		44.5	2.7	3.9	6.9	3.75
40	1 1/2"	48.3	3.0	4.4	7.4	4.25
		51.0	3.1	4.8	7.7	4.40
		57.0	3.9	6.0	10.0	4.60
50	2"	60.3	4.1	6.5	10.5	4.75
		63.5	4.4	7.0	11.0	4.75
		70.0	4.8	8.1	13.4	4.75
65	2 1/2"	76.1	5.3	9.2	14.8	5.50
		82.5	6.3	10.9	19.2	5.75
80	3"	88.9	6.8	12.2	20.4	6.00
		101.6	8.8	15.8	27.0	6.00
		108.0	9.3	17.3	29.1	6.00
100	4"	114.3	9.9	18.9	30.6	6.00
		127.0	12.2	23.3	36.1	6.00
		133.0	12.8	25.1	37.8	6.00
125	5"	139.7	13.5	27.1	40.3	6.00
		152.4	16.5	32.7	47.1	6.00
		159.0	17.3	34.9	49.2	6.00
		165.1	17.9	37.1	52.0	6.00
150	6"	168.3	18.3	38.2	53.0	6.00
		177.8	21.4	43.6	58.1	6.00
		193.7	25.2	51.5	68.0	6.00
200	8"	219.1	31.2	65.0	83.3	6.00
		244.5	37.2	79.5	98.6	6.00
		267.0	40.8	91.6	112.7	6.00
250	10"	273.0	41.6	94.9	117.7	6.00
300	12"	323.9	55.6	131.0	156.6	6.00

1) Heat insulation: density 120 kg/m³ + sheet metal jacket: density 7865 kg/m³2) Heat insulation: density 120 kg/m³

The corresponding pipe manufacturer's data are to be considered.

Copper pipe acc. to DIN EN 1057						
DN	Size	Pipe outer- ϕ	Pipe weight empty	Pipe weight waterfilled	Pipe weight waterfilled + insulated ¹⁾	Support widths
		[mm]	[kg/m]	[kg/m]	[kg/m]	
10	–	17.2	0.6	0.8	1.8	1.3
15	–	21.3	1.0	1.2	2.3	1.5
20	–	26.9	1.3	1.7	2.9	2.0
25	–	33.7	1.6	2.3	4.3	2.3
32	–	42.4	2.0	3.2	5.2	2.8
40	–	48.3	2.3	3.9	6.8	3.0
50	–	60.3	2.9	5.4	9.5	3.5
65	–	76.1	3.7	7.8	13.5	4.3
80	–	88.9	4.4	10.0	18.2	4.8
100	–	114.3	7.3	16.6	28.3	5.0
125	–	139.7	8.9	23.1	36.4	5.0
150	–	168.3	13.2	34.1	48.9	5.0
200	–	219.1	17.3	52.8	71.2	5.0
250	–	273.0	21.6	80.1	100.9	5.0
300	–	323.9	25.7	108.1	132.0	5.0
400	–	406.4	32.3	162.0	190.6	5.0
500	–	508.0	40.4	243.1	279.8	5.0

Threaded pipe acc. to DIN 2440 / DIN EN 10255						
DN	Size	Pipe outer- ϕ	Pipe weight empty	Pipe weight waterfilled	Pipe weight waterfilled + insulated ¹⁾	Support widths
		[mm]	[kg/m]	[kg/m]	[kg/m]	
8	1/4"	13.5	0.7	0.7	1.6	2.00
10	3/8"	17.2	0.9	1.0	2.0	2.25
15	1/2"	21.3	1.2	1.4	2.5	2.75
20	3/4"	26.9	1.6	2.0	3.2	3.00
25	1"	33.7	2.4	3.0	5.1	3.50
32	1 1/4"	42.4	3.1	4.2	6.2	3.75
40	1 1/2"	48.3	3.6	5.0	8.0	4.25
50	2"	60.3	5.1	7.3	11.4	4.75
65	2 1/2"	76.1	6.5	10.2	15.9	5.50
80	3"	88.9	8.5	13.6	21.8	6.00
100	4"	114.3	12.1	20.8	32.5	6.00
125	5"	139.7	16.2	29.5	42.7	6.00
150	6"	165.1	19.2	38.2	53.1	6.00

1) Heat insulation: density 120 kg/m³ + sheet metal jacket: density 7865 kg/m³
The corresponding pipe manufacturer's data are to be considered.

Copper pipe acc. to DIN EN 1057						
DN	Size	Pipe outer- \varnothing	Pipe weight empty	Pipe weight waterfilled	Pipe weight waterfilled + insulated ¹⁾	Support widths
		[mm]	[kg/m]	[kg/m]	[kg/m]	[m]
8	10x1	10	0.3	0.3	0.4	1.00
10	12x1	12	0.3	0.4	0.5	1.25
12	15x1	15	0.4	0.5	0.8	1.25
15	18x1	18	0.5	0.7	1.0	1.50
20	22x1	22	0.6	0.9	1.3	2.00
25	28x1.5	28	1.1	1.6	2.4	2.25
32	35x1.5	35	1.4	2.2	3.1	2.75
40	42x1.5	42	1.7	2.9	4.4	3.00
50	54x2	54	2.9	4.9	7.3	3.50
50	64x2	64	3.5	6.3	9.8	4.00
65	76.1x2	76.1	4.1	8.2	14.0	4.25
80	88.9x2	88.9	4.9	10.5	16.4	4.75
100	108x2.5	108	7.4	15.75	27.5	5.00

Stainless steel pressure system						
DN	Size	Pipe outer- \varnothing	Pipe weight empty	Pipe weight waterfilled	Pipe weight waterfilled + insulated ¹⁾	Support widths
		[mm]	[kg/m]	[kg/m]	[kg/m]	[m]
12	15x1	15	0.3	0.5	0.8	1.50
15	18x1	18	0.4	0.6	1.0	1.50
20	22x1.2	22	0.6	0.9	1.3	2.50
25	28x1.2	28	0.8	1.3	2.4	2.50
32	35x1.5	35	1.2	2.0	3.1	3.50
40	42x1.5	42	1.5	2.7	4.4	3.50
50	54x1.5	54	2.0	4.0	7.3	3.50
65	76.1x2	76.1	3.6	7.6	14.0	5.00
80	88.9x2	88.9	4.2	9.8	16.4	5.00
100	108x2	108	5.1	13.5	27.5	5.00

Metal composite pipe						
DN	Size	Pipe outer- \varnothing	Pipe weight empty	Pipe weight waterfilled	Pipe weight waterfilled + insulated ¹⁾	Support widths
		[mm]	[kg/m]	[kg/m]	[kg/m]	[m]
10	14x2	14	0.1	0.2	0.4	1.0
12	16x2.25	16	0.1	0.2	0.5	1.0
15	20x2.5	20	0.2	0.4	0.7	1.0
20	26x3	26	0.3	0.6	0.9	1.5
25	32x3	32	0.4	0.9	1.2	2.0
32	40x3.5	40	0.6	1.5	2.1	2.0
40	50x4	50	0.9	2.3	3.2	2.5
50	63x4.5	63	1.3	3.6	5.2	2.5

1) Heat insulation: density 120 kg/m³ + sheet metal jacket: density 7865 kg/m³
The corresponding pipe manufacturer's data are to be considered.

Drain pipe. Cast iron. SML. DIN 19522

DN	Pipe outer- \varnothing	Pipe weight empty	Pipe weight water filled	Support widths	
	[mm]	[kg/m]	[kg/m]	[m]	
40	48	3.1	4.5	1)	
50	58	4.3	6.4	1)	
70	78	5.9	9.9	1)	
80	83	6.1	10.6	1)	
100	110	8.4	17.7	1)	
125	135	11.8	24.5	1)	
150	160	14.1	32.3	1)	
200	210	23.1	54.6	1)	
250	274	33.3	87.7	1)	
300	326	43.2	120.8	1)	
400	429	60.0	193.3	1)	
500	532	82.6	290.1	1)	

Drain pipe. PVC-U. DIN 8062

DN	Pipe outer- \varnothing [mm]	Pipe weight empty [kg/m]	Pipe weight water filled [kg/m]	Support widths	
				20° [m]	40° [m]
40	50	0.8	1.3	0.8	0.6
50	63	1.3	2.0	1.1	0.7
65	75	1.8	3.9	1.3	0.8
80	90	2.6	3.9	1.3	0.8
100	110	3.9	8.0	1.6	1.0
125	125	5.0	12.4	1.8	1.1
150	160	8.2	18.0	2.2	1.2

10

LORO-X steel drain pipe

DN	Pipe outer- \varnothing	Pipe weight empty	Pipe weight water filled	Support widths	
	[mm]	[kg/m]	[kg/m]	[m]	
40	42	1.5	2.7	1)	
50	53	2.2	4.2	1)	
70	73	3.3	7.1	1)	
80	89	4.1	9.9	1)	
100	102	5.8	13.3	1)	
125	133	9.6	22.5	1)	
150	159	11.5	30.1	1)	
200	219	21.5	57.2	1)	
250	273	22.5	78.5	1)	
300	324	25.0	104.4	1)	

Note: The values for the max. support widths are based on the permissible deflection under load of the pipes and the corresponding recommendations from the pipe manufacturer. The permissible loads of the pipe fasteners and mountings are not taken into consideration.

1) approx. 1,50 m – 2,00 m. According to the manufacturer's data, each pipe length should be supported in at least two places. The corresponding data from the pipe manufacturer are to be taken into consideration.

Drain pipe. GA. DIN 19500

DN	Pipe outer- \varnothing [mm]	Wall thickness [mm]	Pipe weight empty [kg/m]	Pipe weight water filled [kg/m]	Support widths [m]
50	60	3.5	5.19	7.39	1)
70	80	3.5	7.02	11.21	1)
100	112	4.0	11.33	19.83	1)
125	137	4.0	13.96	27.03	1)
150	162	5.0	20.59	38.74	1)
200	212	6.0	32.42	63.84	1)

Drain pipe. PE. DIN 19535

DN	Pipe outer- \varnothing [mm]	Pipe weight empty [kg/m]	Pipe weight water filled [kg/m]	Support widths [m]
25	32	0.3	0.8	0.5
32	40	0.3	1.3	0.5
40	50	0.4	2.0	0.8
50	56	0.5	2.5	0.8
57	63	0.6	3.1	0.8
70	75	0.7	4.4	0.8
80	90	1.0	6.4	0.9
100	110	1.4	9.5	1.1
125	125	1.8	12.3	1.3
125	140	2.3	15.4	1.4
150	160	3.0	20.1	1.6
200	200	3.8	31.5	2.0
250	250	6.0	49.2	2.0

10

Spiral lock seam pipe. round. acc. to DIN EN12237

DN	71	80	90	100	112	125	140	150	160	180	200	224	250	280	300	315	355	400	450	500	560	600	630	710	800	900	1000	1120	1250
Pipe outer- \varnothing [mm]	75	84	94	105	117	130	145	155	165	185	205	229	255	285	307	322	362	407	457	507	567	609	639	719	810	1012	1012	1132	1262
Sheet thick-ness [mm]	0.4	0.4	0.4	0.6	0.6	0.6	0.6	0.6	0.6	0.6	0.6	0.6	0.6	0.6	0.8	0.8	0.8	0.8	0.8	0.8	0.8	1.0	1.0	1.0	1.0	1.0	1.2	1.2	1.2
Pipe weight empty [kg/m]	0.8	0.9	1.0	1.7	1.9	2.1	2.4	2.6	2.7	3.1	3.4	3.8	4.2	4.7	5.2	7.1	8.0	9.0	10.2	11.3	12.6	13.5	17.7	20.0	22.5	25.4	34.9	39.1	43.7

Weights of galvanized air ducts in kg/m with insulation (80 kg/m³, 5 cm thickness)

Sheet metal 0.75			Sheet metal 0.88						Sheet metal 1.0						Sheet metal 1.13						Sheet metal 1.25					
200	224	250	280	315	355	400	450	500	560	630	710	800	900	1000	1120	1250	1400	1600	1800	2000	2240	2500	2800	3150	B	H
9.1	9.6	10.2	12.1	13.0	14.0	15.2	16.4	17.7	21.0	22.9	25.1	27.6	30.4	33.2	39.8	43.8	48.3	54.3	60.4	66.4	79.4	87.8	97.6	109.0	200	
-	10.2	10.8	12.7	13.6	14.6	15.8	17.0	18.3	21.7	23.6	25.8	28.3	31.1	33.8	40.6	44.5	49.0	55.0	61.1	67.1	80.2	88.6	98.4	109.8	224	
-	-	11.4	13.4	14.3	15.3	16.4	17.7	19.0	22.4	24.3	26.5	29.0	31.8	34.5	41.3	45.3	49.8	55.8	61.9	67.9	81.0	89.5	99.2	110.6	250	
-	-	-	14.2	15.0	16.0	17.2	18.4	19.7	23.2	25.1	27.3	29.8	32.6	35.4	42.2	46.2	50.7	56.7	62.8	68.8	82.0	90.4	100.2	111.6	280	
-	-	-	-	15.9	16.9	18.1	19.3	20.6	24.2	26.1	28.3	30.8	33.6	36.3	43.3	47.2	51.8	57.8	63.8	69.9	83.1	91.6	101.3	112.7	315	
-	-	-	-	-	17.9	19.1	20.3	21.6	25.3	27.2	29.4	31.9	34.7	37.4	44.5	48.4	53.0	59.0	65.0	71.1	84.4	92.9	102.6	114.0	355	
-	-	-	-	-	-	20.2	21.5	22.7	26.5	28.5	30.7	33.2	35.9	38.7	45.9	49.8	54.3	60.4	66.4	72.4	85.9	94.3	104.1	115.5	400	
-	-	-	-	-	-	-	22.7	24.0	27.9	29.8	32.0	34.5	37.3	40.1	47.4	51.3	55.8	61.9	67.9	73.9	87.5	96.0	105.7	117.1	450	
-	-	-	-	-	-	-	-	25.3	29.3	31.2	33.4	35.9	38.7	41.4	48.9	52.8	57.3	63.4	69.4	75.4	89.1	97.6	107.4	118.7	500	
-	-	-	-	-	-	-	-	-	30.9	32.9	35.1	37.6	40.3	43.1	50.7	54.6	59.1	65.2	71.2	77.3	91.1	99.5	109.3	120.7	560	
-	-	-	-	-	-	-	-	-	-	34.8	37.0	39.5	42.3	45.0	52.8	56.7	61.3	67.3	73.3	79.4	93.4	101.8	111.6	123.0	630	
-	-	-	-	-	-	-	-	-	-	-	39.2	41.7	44.5	47.2	55.2	59.1	63.7	69.7	75.7	81.8	96.0	104.4	114.2	125.6	710	
-	-	-	-	-	-	-	-	-	-	-	-	44.2	47.0	49.7	57.9	61.9	66.4	72.4	78.5	84.5	98.9	107.4	117.1	128.5	800	
-	-	-	-	-	-	-	-	-	-	-	-	-	49.7	52.5	61.0	64.9	69.4	75.4	81.5	87.5	102.1	110.6	120.4	131.8	900	
-	-	-	-	-	-	-	-	-	-	-	-	-	-	55.3	64.0	67.9	72.4	78.5	84.5	90.5	105.4	113.9	123.6	135.0	1000	
-	-	-	-	-	-	-	-	-	-	-	-	-	-	-	67.6	71.5	76.0	82.1	88.1	94.1	109.3	117.8	127.5	138.9	1120	
-	-	-	-	-	-	-	-	-	-	-	-	-	-	-	-	75.4	80.8	86.0	92.0	98.1	113.5	122.0	131.8	143.1	1250	
-	-	-	-	-	-	-	-	-	-	-	-	-	-	-	-	-	84.5	90.5	96.6	102.6	118.4	126.9	136.6	148.0	1400	
-	-	-	-	-	-	-	-	-	-	-	-	-	-	-	-	-	-	96.6	102.6	108.6	124.9	133.4	143.1	154.5	1600	
-	-	-	-	-	-	-	-	-	-	-	-	-	-	-	-	-	-	-	108.6	114.7	131.4	139.9	149.6	161.0	1800	
-	-	-	-	-	-	-	-	-	-	-	-	-	-	-	-	-	-	-	-	120.7	137.9	146.4	156.2	167.5	2000	
-	-	-	-	-	-	-	-	-	-	-	-	-	-	-	-	-	-	-	-	-	145.7	154.2	164.0	175.3	2240	
-	-	-	-	-	-	-	-	-	-	-	-	-	-	-	-	-	-	-	-	-	-	162.7	172.4	183.8	2500	
-	-	-	-	-	-	-	-	-	-	-	-	-	-	-	-	-	-	-	-	-	-	-	182.2	193.6	2800	
-	-	-	-	-	-	-	-	-	-	-	-	-	-	-	-	-	-	-	-	-	-	-	-	204.9	3150	

Weights of galvanized ventilation ducts in kg/m without insulation

Sheet metal 0.75			Sheet metal 0.88						Sheet metal 1.0						Sheet metal 1.13						Sheet metal 1.25					
200	224	250	280	315	355	400	450	500	560	630	710	800	900	1000	1120	1250	1400	1600	1800	2000	2240	2500	2800	3150	B	H
5.9	6.2	6.6	8.3	8.9	9.6	10.4	11.2	12.1	14.9	16.3	17.9	19.6	21.6	23.6	29.3	32.2	35.5	39.9	44.4	48.8	59.9	66.2	73.6	82.8	200	
-	6.6	7.0	8.7	9.3	10.0	10.8	11.6	12.5	15.4	16.8	18.3	20.1	22.1	24.0	29.8	32.7	36.0	40.4	44.9	49.3	60.4	66.8	74.2	82.2	224	
-	-	7.4	9.2	9.8	10.4	11.2	12.1	13.0	15.9	17.3	18.8	20.6	22.6	24.5	30.4	33.3	36.6	41.0	45.5	49.9	61.1	67.5	74.8	83.4	250	
-	-	-	9.7	10.3	11.0	11.7	12.6	13.5	16.5	17.9	19.4	21.2	23.2	25.1	31.0	33.9	37.3	41.7	46.1	50.6	61.8	68.2	75.6	84.1	280	
-	-	-	-	10.9	11.6	12.3	13.2	14.1	17.2	18.5	20.1	21.9	23.8	25.8	31.8	34.7	38.0	42.5	46.9	51.3	62.7	69.1	76.4	85.0	315	
-	-	-	-	-	12.3	13.0	13.9	14.8	18.0	19.3	20.9	22.7	24.6	26.6	32.7	35.6	38.9	43.4	47.8	52.2	63.7	70.0	77.4	86.0	355	
-	-	-	-	-	-	13.8	14.7	15.5	18.8	20.2	21.8	23.6	25.5	27.5	33.7	36.6	39.9	44.4	48.8	53.2	64.8	71.1	78.5	87.1	400	
-	-	-	-	-	-	-	15.5	16.4	19.8	21.2	22.8	24.5	26.5	28.5	34.8	37.7	41.0	45.5	49.9	54.3	66.0	72.4	79.7	88.3	450	
-	-	-	-	-	-	-	-	17.3	20.8	22.2	23.7	25.5	27.5	29.4	35.9	38.8	42.1	46.6	51.0	55.4	67.2	73.6	81.0	89.5	500	
-	-	-	-	-	-	-	-	-	22.0	23.4	24.9	26.7	28.7	30.6	37.3	40.1	43.5	47.9	52.3	56.8	68.7	75.1	82.4	91.0	560	
-	-	-	-	-	-	-	-	-	-	24.7	26.3	28.1	30.0	32.0	38.8	41.7	45.0	49.5	53.9	58.3	70.4	76.8	84.1	92.7	630	
-	-	-	-	-	-	-	-	-	-	-	27.9	29.6	31.6	33.6	40.6	43.5	46.8	51.2	55.7	60.1	72.4	78.7	86.1	94.7	710	
-	-	-	-	-	-	-	-	-	-	-	-	31.4	33.4	35.3	42.6	45.5	48.8	53.2	57.7	62.1	74.6	81.0	88.3	96.9	800	
-	-	-	-	-	-	-	-	-	-	-	-	-	35.3	37.3	44.8	47.7	51.0	55.4	59.9	64.3	77.0	83.4	90.8	99.4	900	
-	-	-	-	-	-	-	-	-	-	-	-	-	-	39.3	47.0	49.9	53.2	57.7	62.1	66.5	79.5	85.9	93.2	101.8	1000	
-	-	-	-	-	-	-	-	-	-	-	-	-	-	-	49.7	52.6	55.9	60.3	64.8	69.2	82.4	88.8	96.2	104.7	1120	
-	-	-	-	-	-	-	-	-	-	-	-	-	-	-	-	55.4	58.8	63.2	67.6	72.1	85.6	92.0	99.4	107.9	1250	
-	-	-	-	-	-	-	-	-	-	-	-	-	-	-	-	-	62.1	66.5	71.0	75.4	89.3	95.7	103.0	111.6	1400	
-	-	-	-	-	-	-	-	-	-	-	-	-	-	-	-	-	-	71.0	75.4	79.8	94.2	100.6	107.9	116.5	1600	
-	-	-	-	-	-	-	-	-	-	-	-	-	-	-	-	-	-	-	79.8	84.3	99.1	105.5	112.8	121.4	1800	
-	-	-	-	-	-	-	-	-	-	-	-	-	-	-	-	-	-	-	-	-	88.7	104.0	110.4	117.8	2000	
-	-	-	-	-	-	-	-	-	-	-	-	-	-	-	-	-	-	-	-	-	-	109.9	116.3	123.6	2240	
-	-	-	-	-	-	-	-	-	-	-	-	-	-	-	-	-	-	-	-	-	-	-	122.7	130.0	2500	
-	-	-	-	-	-	-	-	-	-	-	-	-	-	-	-	-	-	-	-	-	-	-	-	137.4	2800	
-	-	-	-	-	-	-	-	-	-	-	-	-	-	-	-	-	-	-	-	-	-	-	-	-	3150	

The weights in kg/m are reference values. The weights can deviate, depending on the sheet metal thickness and the type of flange used. The flange weight is included flat -rate. The loads based on a mineral wool weight of 80 kg/m2 and a thickness of 5 cm.

Important dimensions, variables and units.

Comparison of material standards			
DIN EN ISO		DIN EN ISO	
Description	Material-No.		ASTM
S250GD+Z	1.0242	EN10027-2	A653
DD11	1.0332	DIN EN 10111	A621CQ
DC01	1.0330	DIN EN 10130	A366
St22	1.0320	DIN 1614-1	n/a
DX51D+Z275NA-C	1.0226+Z	DIN EN 10327	A653/CQ
S235JR	1.0037	DIN EN 10025	A283
S355MC	1.0976	DIN EN 10149	n/a
4.6; 4.8	DIN EN ISO 898-1		F568M

Variables and units					
Size	Formula symbol [mm]	Unit SI [mm]	others [kg/m]	related [kg/m]	Note [m]
Length	l	m	-	1 m = 10 dm = 100 cm = 1.000 mm 1 mm = 1.000 µm 1 km = 1.000 m	1 inch = 1 Zoll = 25.4 mm
Area	A, S	m ²	a, ha	1 m ² = 10.000 cm ² = 1.000.000 m ² 1 a = 100 m ² 1 ha = 100 a = 10.000 m ²	-
Volume	V	m ³	l	1 m ³ = 1.000 dm ³ = 1.000.000 cm ³ 1 l = 1 dm ³ = 0.001 m ³ 1 ml = 1 cm ³	-
Time	t	s	min, h, d	1 min = 60 s 1 h = 60 min = 3.600 s 1 d = 24 h	-
Frequency	f	Hz	-	1 Hz = 1/s	-
Speed	v	m/s	m/s, km/h	1 m/s = 3.6 km/h	-
Acceleration	a, g	m/s ²	-	g = 9.81 m/s ²	Formula character g only for acceleration due to gravity
Weight	m	kg	g, t	1 kg = 1.000 g 1 t = 1.000 kg	-
Density	ρ	kg/m ³	-	1.000 kg/m ³ = 1 t/m ³ = 1 kg/dm ³	-
Moment of inertia, 2nd degree	J	kg · m ²	-	-	Formerly: Mass moment of inertia
Force	F	N	-	1 N = 1 kg · m/s ²	Formerly: kp (kilopond) 1 kp = 9,80665 kgm/s ² = 9,81 N
Torque	M	N · m	-	-	-
Bending moment	Mb	N · m	-	-	-
Torsion moment	T	N · m	-	-	-
Mechanical tension	σ, τ	N/m ²	-	-	-
Area-wise moment, 2nd degree	I	m ⁴	-	-	Formerly: Area moment of inertia
Energy, work	E, W	J	-	1 J = 1 N · m = 1 W · s	Formerly: cal (calorie) 1 cal = 4,1868 Ws = 4,19 J
Power	P	W	-	1 W = 1 J/s = 1 N · m/s	Formerly: hp (horsepower) 1 PS = 75 kpm/s = 75 · 9,81 N/ms = 0,736 kW
Thermodynamic temperature	T	K	-	0 °C = 273 K -273 °C = 0 K	-
Heat quantity	Q	J	(Wh)	1 J = 1 W · s = 1 N · m	-
Specific heat value	H	J/kg	-	-	-
Substance quantity	n	mol	-	1 corresponds to approx 6 · 10 ²³	-
Light intensity	lv	cd	-	-	-

Approvals, markings and their importance.

In the following, excerpts of approvals that are currently issued in Europe and their symbols will be given with their corresponding importance. Please check whether your application is safety relevant.

An application is safety relevant when failure of anchorages would cause risk to human life or serious injuries and/or lead to considerable economic consequences. In this case please use anchors with a European Technical (ETA) or with a German Approval. You may recognise these anchors by:



European Technical Approval:

issued by a European approval authority (e.g. DIBt) on the basis of the guidelines for European technical approvals (ETAG) ETA: European Technical Approval/Options 1–12

CE: European conformity mark confirms the compliance of the building product (e.g. fixing) with the guidelines for European Technical Approvals. Products with the CE mark can be freely traded in the European economic market.



General Building Authority Approval:

German approval, issued by the DIBt, Berlin for anchorings in concrete to be dimensioned according to Method A (CC method).

Proof of compliance of the building product with the general building authority approval. confirmed by a material testing facility.



ICC = International Code Council, formed from BOCA, ICBO & SBCCI:

ICC Evaluation Service Inc. (ICC ES) issues evaluation reports, in this case for the above anchor based upon the Uniform Building Code™ and related codes in the United States of America.



General Building Authority Approval:

German approval, issued by the DIBt, Berlin. Proof of compliance of the building product with the general building authority approval. confirmed by a material testing facility.



FM Certificate:

Recognised for use in local water-based fire extinguisher systems (Factory Mutual Research Corporation for Property Conservation, American insurance company).



Product is available in highly corrosion resistant steel of corrosion resistance class IV, e.g. 1.4529.

10

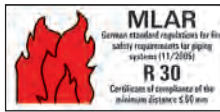

Fire-tested product MLAR:

The product was subjected to a fire test. A "Examination report regarding testing according to the German Muster-Leitungsanlagenrichtlinie" (MLAR) is available.



Fire-tested fixing:

The fixing or installation product was subjected to a fire test. A "Examination report regarding testing for fire behaviour" according to EN 13501 (with R class) is available.



Fire-tested fixing:

The fixing was subjected to a fire test. A "Examination report regarding testing for fire behaviour" (with R class) is available.



Fire-tested product DIN EN 1366-1:

The product was subjected to a fire test. A "Examination report" according to DIN EN 16366-1 is available.



Fire-tested product DIN 4102-2:

The product was subjected to a fire test. A "Examination report" according to DIN 4102-2 is available.

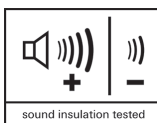

Sound insulation tested according to DIN 4109:

The product was subjected to a sound insulation test. A "measurement of the insertion loss" is available in a test report.



VdS-Certificate:

Recognised for the use in local water-based fire extinguisher systems (formerly: Association of Property Insurers, now: VdS Damage Prevention)



UL Certificate:

Recognised as pipe hangers for use e.g. in local water-based fire extinguisher systems (UL Online Certification Directory, VFXT.EX 16429).

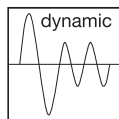

Fixing that can be dynamically loaded:

The fixing is suitable and approved for anchoring of "not predominantly static" (i.e. dynamic) loads.

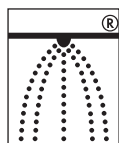

Sprinkler Systems:

Meets the requirements according to VdS CEA 4001.



Sound insulation tested

according DIN 4109: The product was subjected to a sound insulation test. A "measurement of the insertion loss" is available in a test report.



Tested for flame resistance according to VDE.



VdS-Certificate:

Recognised for the use in local water-based fire extinguisher systems (formerly: Association of Property Insurers, now: VdS Damage Prevention)



UL Certificate:

Recognised as pipe hangers for use e.g. in local water-based fire extinguisher systems (UL Online Certification Directory, VFXT.EX16429).

10

Main catalogue Fixing Systems.

Products for use in fixing technology

The fixing catalogue offers all facts and helps with quick and safe product selection, e.g.:

- Product descriptions with advantages/benefits at a glance
- Assembly tips
- Application support
- Detailed technical data and drawings
- Basics knowledge of fixing technology
- Everything you need to know about professional fixing

Don't wait. Require the main catalogue Fixing Systems at the Hotline +49 (0) 180 5 202901 or per fax to +49 (0) 7443 12-4500.



Subsidiaries.

Germany

fischer Deutschland Vertriebs GmbH
Klaus-Fischer-Straße 1
72178 Waldachtal
T +49 7443 12-6000
F +49 7443 12-4500
info@fischer.de
www.fischer.de

Argentina

fischer Argentina s.a.
Armenia 3044
1605 Munro Ra-PCIA Buenos Aires
T +54 1147 62 27 78
F +54 1147 56 13 11
asistenciaticnica@fischer.com.ar
www.fischer.com.ar

Austria

fischer Austria GmbH
Wiener Straße 95
2514 Traiskirchen
T +43 2252 53730 0
F +43 2252 53730 70
office@fischer.at
www.fischer.at

10 Belgium

fischer Cobemabel snc
Schaliënhoevedreef 20 D
2800 Mechelen
T +32 152 8 47 00
F +32 152 8 47 10
info@fischer.be
www.fischer.be

Brazil

fischer brasil Industria e Comercio Ltda.
Estrada do Dende, 300 Ilha do Governador
21920-001 Rio de Janeiro-RJ
T +55 21 2467 11 30
F +55 21 2467 01 44
fischer@fischerbrasil.com.br
www.fischerbrasil.com.br

China

fischer (Taicang) fixings Co. Ltd.
Building 1, Suntec Industrial Park, No.105
North Dongcang Road, 215400 Taicang,
Jiangsu
T +86 512 53 58 89 38
F +86 512 53 58 89 48
ficn@fischer.com.cn
www.fischer.com.cn

Czech Republic

fischer international s.r.o.
Průmyslová 1833
25001 Brandýs nad Labem
T +42 03 26 90 46 01
F +42 03 26 90 46 00
info@fischer-cz.cz
www.fischer-cz.cz

Denmark

fischer a/s
Sandvadsvej 17 A
4600 Køge
T +45 46 32 02 20
F +45 46 32 50 52
fidk@fischerdenmark.dk
www.fischerdenmark.dk

Finland

fischer Finland Oy
Suomalaistentie 7 B
02270 Espoo
T +358 20 741 46 60
F +358 20 741 46 69
orders@fischerfinland.fi
www.fischerfinland.fi

France

fischer S. A. S.
12, rue Livio, P. O. Box 10182
67022 Strasbourg-Cedex 1
T +33 388 39 18 67
F +33 388 39 80 44
info@fischer.fr
www.fischer.fr

Greece

fischer Hellas
Nat. Road Athens-Lamia (17th) &
Roupef 6, 14564 Kifissia Athens
T +30 210 283 81 67
F +30 210 283 81 69
info@fischer.gr
www.fischer.gr

Hungary

fischer Hungária Bt.
Szerémi út 7/b
1117 Budapest
T +36 1 347 97 55
F +36 1 347 97 66
info@fischerhungary.hu
www.fischerhungary.hu

India

fischer BUILDING MATERIAL INDIA PVT LTD.
PRESTIGE GARNET UNIT NO- 401,
4TH FLOOR 36, ULSOOR ROAD
560042 Bangalore KARNATAKA
T +91 08041511991 92 93
F +91 08041511989
info@fischer.in
www.fischer.in

Italy

fischer italia S.R.L
Corso Stati Uniti, 25, Casella Postale 391
35127 Padova Z.I. Sud
T +39 049 8 06 31 11
F +39 049 8 06 34 01
sercli@fischeritalia.it
www.fischeritalia.it

Japan

fischer Japan K.K.
Pronte Kudan Building 3rd Floor 3-4-15
Kudan Minami Chiyoda-ku, 102-0074 Tokyo
T +81 33 26 34 49 1
F +81 36 27 29 93 5
info@fischerjapan.co.jp
www.fischerjapan.co.jp

Korea, Republic

fischer Korea Co., Ltd (fikr)
Room 601/602, Kolon Digital Billant 30,
Digitalro 32-Gil, Guro-Gu, Seoul,
Korea 08390
T +82 1544 89 55
F +82 1544 89 03
info@fiskerkorea.com
www.fiskerkorea.com

Mexico

fischer Sistemas de Fijación, S.A. de C.V.
Blvd. Manuel Avila Camacho 3130-400B
54020 Col. Valle Dorado, Tlalnepantla
T +52 55 55 72 08 83
F +52 55 55 72 15 90
info@fiskermex.com.mx
www.fiskermex.com.mx

Netherlands

fischer Benelux B.V.
Amsterdamsestraatweg 45 B/C
1411 AX Naarden
T +31 35 6 95 66 66
F +31 35 6 95 66 99
info@fischer.nl
www.fischer.nl

Norway

fischer Norge AS
Oluf Onsumsvei 9
0680 Oslo
T +47 23 24 27 10
F +47 23 24 27 13
ordre@fischernorge.no
www.fischernorge.no

Philippines

fischer PH Asia, Inc.
No 100 Congressional Avenue, Project 8
1106 Quezon City
T +63 2426 / 0888 217
F +63 28803256
joselito.ladlad@fischerph.com
www.fischer.ph

Poland

fischerpolska Sp.z o.o
ul. Albatrosow 2
30-716 Kraków
T +48 12 2 90 08 80
F +48 12 2 90 08 88
info@fischerpolska.pl
www.fischerpolska.pl

Portugal

fischerwerke Portugal, Lda.
Rua das Musas, Passeio dos Cruzados
Lote 2.01 (Bloco3), Loja 8 (01.D) / Parque
das Nações, 1990-171 Lisboa
T +351 218 954 180
F +351 218 967 066
fischerportugal.info@fischer.pt
www.fischer.pt

Qatar

fischer fasteners QD Trading LLC
HUB Business Center, Barwa Commercial
Avenue, Arkan Building, Block No. 4, Office
No. 56, Building No 115, Street 964,
Zone 56 Doha

Russian Federation

OOO fischer Befestigungssysteme Rus
Leningradskoe shosse, 47, Bldg. 2, 2nd
floor, apt. VI, 125195 Moscow
T +7 495 223 61 62
F +7 495 223 03 34
info@fischerfixings.ru
www.fischerfixings.ru

Romania

fischer fixings Romania S.R.L.
Strada Oradiei, Nr. 1-3-5-7
400220 Cluj
T +40 264 455 166
F +40 264 403060
zoltan.kovacs@fischer.com.ro
www.fischer.com.ro

Singapore

fischer systems Asia Pte. Ltd.
4 Kaki Bukit Avenue 1, #01-06
417939 Singapore
T +65 6741 0480
F +65 6741 0481
sales@fischer.sg
www.fischer.sg

Slovakia

fischer S.K. s.r.o.
Nová Rožňavská 134 A
831 04 Bratislava
T +421 2 4920 60 46
F +421 2 4920 60 44
info@fischerwerke.sk
www.fischer-sk.sk

Spain

fischer Ibérica S.A.U.
Klaus Fischer 1
43300 Mont-Roig del Camp Tarragona
T +34 977 83 87 11
F +34 977 83 87 70
servicio.cliente@fischer.es
www.fischer.es

Sweden

fischer Sverige AB
Nygatan 93
602 34 Norrköping
T +46 11 31 44 50
info@fischersverige.se
www.fischersverige.se

Turkey

fischer Metal Sanayi Ve Ticaret Ltd Sti
Cevizli Mahallesi, Mustafa Kemal Paşa Cad.
Seyit Gazi Sok. No 66, Hukukçular Towers A
Blok, 34865 Kartal İstanbul
T +90 216 326 00 66
F +90 216 326 00 18
info@fischer.com.tr
www.fischer.com.tr

United Arab Emirates

fischer FZE
R/A 07, BA - 04, Jebel Ali Free Zone
Dubai
T +97 14 8 83 74 77
F +97 14 8 83 74 76
enquiry@fischer.ae
www.fischer.ae

United Kingdom

fischer fixings UK Ltd.
Whitely Road
Oxon OX10 9AT Wallingford
T +44 1491 82 79 00
F +44 1491 82 79 53
info@fischer.co.uk
www.fischer.co.uk

United States

fischer fixings LLC (fius)
205 US HWY 46, Suite 4 07512 Totowa,
New Jersey
T +1 973 256 30 45
F +1 845 625 26 66
sales@fischerus.net
www.fischerfixings.com

Article list.

Art.-No.	Article	Page	Art.-No.	Article	Page	Art.-No.	Article	Page
14319	VM M 6	215	24431	ETR 126 - 133	63	40398	GPS M 12	206
14320	WDP 10 x 170	393	24432	ETR 131 - 140	63	40457	FPS-FPB 4,2 x 13 ZPF 1000	196
14570	ED 22	223	24433	ETR 143 - 153	63	41900	FIS H 12 x 50 K	429
14570	ED 22	383	24434	ETR 150 - 159	63	41901	FIS H 12 x 85 K	429
15014	BSM 6	377	24435	ETR 168	63	41902	FIS H 16 x 85 K	429
15015	BSM 8	377	24436	ETR 193,7	63	41903	FIS H 16 x 130 K	429
15016	BSM 10	377	24437	ETR 219	63	41904	FIS H 20 x 85 K	429
15017	BSM 12	377	24637	LGS 450	187	42535	FRS 15 - 19 M8/M10	37
15018	BSM 14	377	24638	LGS 500	187	42536	FRS 20 - 24 M8/M10	37
15019	BSM 30	377	24639	LGS 560	187	42537	FRS 25 - 30 M8/M10	37
15021	BSM 42	378	24640	LGS 600	187	42538	FRS 32 - 37 M8/M10	37
15068	BSMD 10	377	24643	LGS 800	187	42554	FRS 40 - 45 M8/M10	37
15069	BSMD 12	377	24644	LGS 900	187	42555	FRS 55 - 61 M8/M10	37
15070	BSMD 14	377	24645	LGS 1000	187	43275	TKL Ø 13	201
15076	BSMD 26	377	24646	LGS 1120	187	43631	FIS E 11 x 85 M6	429
15081	BSMD 42	378	24647	LGS 1250	187	43632	FIS E 11 x 85 M8	429
15082	BSMD 47	378	24648	DPF 60 - 105	212	43633	FIS E 15 x 85 M10	429
15093	BSM 15	377	24649	U 12 x 40	157	43634	FIS E 15 x 85 M12	429
18652	WB 5N	396	24649	U 12 x 40	214	44109	FNA II 6 x 30 M6/5	418
19802	BN 3,6 x 200	385	24650	MU M 12	157	44110	FNA II 6 x 30 M6 x 41	419
20914	FHS CLIX S 8 x 30	130	24650	MU M 12	215	44111	FNA II 6 x 25 M6/5	418
20915	FHS CLIX S 8 x 40	130	24671	LKH	188	44112	FNA II 6 x 30 M6/5 R	418
20916	FHS CLIX S 8 x 60	130	24674	ZKH	189	44113	FNA II 6 x 30 M6/5 HCR	418
20917	FHS CLIX S 10 x 30	130	24675	LRB	191	44114	FNA II 6 x 30 M8/5	419
20918	FHS CLIX S 10 x 40	130	24827	SX 6 x 50	438	44115	FNA II 6 x 30/5	418
20919	FHS CLIX S 10 x 60	130	24828	SX 8 x 65	438	44116	FNA II 6 x 30/30	418
20936	RD M 8 / M 6	217	24829	SX 10 x 80	438	44117	FNA II 6 x 30/50	418
20947	PV M 6	211	30138	FHY M 6	420	44118	FNA II 6 x 30/75	418
20949	TKL M 12	201	30139	FHY M 6 R	420	44119	FNA II 6 x 30/100	418
20956	G 6	204	30146	FHY M 8	420	44120	FNA II 6 x 30/120	418
20957	G 12	204	30147	FHY M 8 R	420	44121	FNA II 6 x 25/5	418
20958	G 16	204	30148	FHY M10	420	44122	FNA II 6 x 30/5 R	418
20959	GWB	219	30151	FHY M10 R	420	44123	FNA II 6 x 30/30 R	418
20959	GWB	379	33208	PUP M3	443	44124	FNA II 6 x 30/5 HCR	418
20968	GPS 3/4"	206	33211	FIS HB 345 S	422	44125	FNA II 6 x 30/30 HCR	418
20969	FHS CLIX S 12 x 30	130	37289	GPR 1/2"	206	44559	WIC 2 VE20	389
20971	VM M 12	158	37489	BN 2,6 x 160	385	44560	WIC 2 VE100	389
20971	VM M 12	215	37490	BN 3,6 x 300	385	44561	WIC 3 VE20	389
24415	ETR 8 - 13	63	37501	BN 4,5 x 160	385	44564	WIC 4 VE50	389
24416	ETR 12 - 17	63	37573	UBN 3,6 x 200	385	44565	WI Ø 2 mm	389
24417	ETR 15 - 21	63	37581	BN 4,8 x 178	385	44630	EHS M 6 x 25/30 Plus	417
24418	ETR 20 - 27	63	37582	BN 4,8 x 250	385	44631	EHS M 8 x 25/30 Plus	417
24419	ETR 26 - 34	63	37583	BN 4,8 x 370	385	44632	EHS M 8 x 40 Plus	417
24420	ETR 33 - 42	63	37653	BN 4,8 x 350	385	44633	EHS M 10 x 40 Plus	417
24421	ETR 40 - 49	63	37708	BN 4,8 x 430	385	44634	EHS M 12 x 50 Plus	417
24422	ETR 50 - 60	63	37945	BN 7,8 x 180	385	44635	EHS M 16 x 65 Plus	417
24423	ETR 60 - 70	63	37949	BN 7,8 x 300	385	44636	EHS M 20 x 80 Plus	417
24424	ETR 66 - 76	63	37996	BN 7,6 x 450	385	44721	WIZ	389
24425	ETR 70 - 82	63	37997	BN 7,6 x 550	385	44969	FIS A M 10 x 170	426
24426	ETR 80 - 90	63	37998	BN 8,8 x 760	385	44971	FIS A M 12 x 120	426
24427	ETR 90 - 102	63	38000	BN 8,8 x 810	385	44972	FIS A M 16 x 130	426
24428	ETR 100 - 108	63	38002	BN 8,8 x 1168	385	44973	FIS A M 10 x 170 R	426
24429	ETR 102 - 114	63	40390	FUS 41/2,0 - 2 m	99	44974	FIS A M 12 x 120 R	426
24430	ETR 121 - 127	63	40391	FUS 21/2,0 - 2 m	99	44975	FIS A M 16 x 130 R	426

Art.-No.	Article	Page	Art.-No.	Article	Page	Art.-No.	Article	Page
45517	SGS 9 W2 8 - 12	64	46342	SXR 10 x 100 FUS R	432	48406	EA II M 12 x 50	416
45518	SGS 9 W2 10 - 16	64	46343	SXR 10 x 120 FUS R	432	48408	EA II M 16 x 65	416
45519	SGS 9 W2 12 - 20	64	46344	SXR 10 x 140 FUS R	432	48409	EA II M 20 x 80	416
45520	SGS 9 W2 16 - 27	64	46345	SXR 10 x 160 FUS R	432	48410	EA II M 6 x 30 R	416
45521	SGS 9 W2 20 - 32	64	46361	SXR 10 x 180 FUS R	432	48411	EA II M 8 x 30 R	416
45522	SGS 9 W2 25 - 40	64	46362	SXR 10 x 200 FUS R	432	48412	EA II M 8 x 40 R	416
45523	SGS 9 W2 32 - 50	64	46363	SXR 10 x 230 FUS R	432	48414	EA II M 10 x 40 R	416
45524	SGS 9 W2 40 - 60	64	46632	FAZ II 20/30	406	48415	EA II M 12 x 50 R	416
45525	SGS 9 W2 50 - 70	64	46633	FAZ II 20/60	406	48416	EA II M 16 x 65 R	416
45526	SGS 9 W2 60 - 80	64	46635	FAZ II 24/30	406	48417	EA II M 20 x 80 R	416
45527	SGS 9 W2 70 - 90	64	46636	FAZ II 24/60	406	48487	EHS M 10 x 25/30 Plus	417
45528	SGS 9 W2 80 -100	64	46703	FIS H 20 x 130 K	429	48510	FFPS 2"	164
45529	SGS 9 W2 90 -110	64	46704	FIS H 20 x 200 K	429	48511	FFPS 2 1/2"	164
45530	SGS 9 W2 100 -120	64	47303	FZEA II 10 x 40 M 8	411	48512	FFPS 3"	164
45531	SGS 9 W2 110 -130	64	47304	FZEA II 12 x 40 M10	411	48513	FFPS 4"	164
45532	SGS 9 W2 120 -140	64	47305	FZEA II 14 x 40 M12	411	48660	FFPS 5"	164
45685	TherMax 8/60 M6	434	47306	FZEA II 10 x 40 M 8 R	411	48662	FFPS 159 - 166	164
45686	TherMax 8/80 M6	434	47307	FZEA II 12 x 40 M10 R	411	48663	FFPS 6"	164
45687	TherMax 8/100 M6	434	47308	FZEA II 14 x 40 M12 R	411	48664	FFPS 8"	164
45688	TherMax 8/120 M6	434	47309	FZEA II 10 x 40 M 8 HCR	411	48665	FFPS 10"	164
45689	TherMax 8/140 M6	434	47310	FZEA II 12 x 40 M10 HCR	411	48666	FFPK	164
45690	TherMax 8/160 M6	434	47316	FHS CLIX S 12 x 40	130	49103	DDK TR (DE/EN)	442
45691	TherMax 8/180 M6	434	47726	SBS 12/16	168	49459	FRSN 15 - 19 M8/M10	43
45692	TherMax 10/100 M6	434	48065	EMS M 6 x 25/30	417	49479	UWS	136
45693	TherMax 10/120 M6	434	48066	EMS M 8 x 25/30	417	49789	FRSN 21 - 23 M8/M10	43
45694	TherMax 10/140 M6	434	48067	EMS M 8 x 40	417	49790	FRSN 25 - 28 M8/M10	43
45695	TherMax 10/160 M6	434	48068	EMS M 10 x 25/30	417	49793	FRSN 32 - 36 M8/M10	43
45696	TherMax 10/180 M6	434	48070	EMS M 10 x 40	417	49794	FRSN 38 - 43 M8/M10	43
45697	TherMax 10/100 M8	434	48071	EMS M 12 x 50	417	49902	FRSN 44 - 49 M8/M10	43
45698	TherMax 10/120 M8	434	48072	EMS M 16 x 65	417	49922	FRSN 50 - 56 M8/M10	43
45699	TherMax 10/140 M8	434	48073	EMS M 20 x 80	417	49944	FRSN 57 - 61 M8/M10	43
45700	TherMax 10/160 M8	434	48151	SF plus ES 10	359	49945	FRSN 63 - 70 M8/M10	43
45702	TherMax 10/100 M10	434	48152	SF plus ES 18	359	49947	FRSN 70 - 77 M8/M10	43
45703	TherMax 10/120 M10	434	48154	SS-TKL M10/M12	201	49948	FRSN 80 - 83 M8/M10	43
45704	TherMax 10/140 M10	434	48161	SF plus ZS 18	359	49979	FRSN 83 - 91 M8/M10	43
45705	TherMax 10/160 M10	434	48162	SF plus ZS 28	359	50006	FRSN 100 - 106 M8/M10	43
45956	WIS 2/1	389	48171	SF plus KB 8	363	50008	FRSN 108 - 114 M8/M10	43
45957	WIS 2/2	389	48172	SF plus KB 16	363	50009	FRSN 123 - 128 M8/M10	43
45958	WIS 2/3	389	48181	SF plus MS	365	50010	FRSN 131 - 136 M8/M10	43
45959	WIS 2/5	389	48190	SF plus RC IEC 12	351	50023	FRSN 137 - 146 M8/M10	43
45960	WIS 2/10	389	48191	SF plus RC IEC 16	351	50326	KM 10	393
46022	FNA II 6 x 30 M6/10	419	48193	SF plus RC IEC 20	351	50427	PU 750 B3 (EN/FR/AR)	440
46023	FNA II 6 x 30/40 R	418	48197	SF plus RC IEC 25	351	50571	FHB II-A S M10 x 60/30 R	423
46024	FNA II 6 x 30/50 R	418	48198	SF plus RC IEC 32	351	51290	TherMax 12/110 M12 (2)	435
46025	FNA II 6 x 30/60 R	418	48199	SF plus RC IEC 40	351	51291	TherMax 12/110 M12	435
46204	FIS A M 6 x 70	427	48212	ED 15	223	51292	TherMax 16/170 M12 (2)	435
46329	SXR 10 x 60 FUS	432	48212	ED 15	383	51293	TherMax 16/170 M12	435
46330	SXR 10 x 80 FUS	432	48264	EA II M 6 x 30	416	51537	TherMax 12/110 M12 A4	435
46331	SXR 10 x 100 FUS	432	48284	EA II M 8 x 30	416	51543	TherMax 16/170 M12 A4	435
46332	SXR 10 x 120 FUS	432	48308	NSB 2/40	371	52370	FHB II-A L M20 x 210/150	425
46333	SXR 10 x 140 FUS	432	48309	NSB 2/50	371	52456	FFC 2/30-32	451
46334	SXR 10 x 160 FUS	432	48310	NSB 2/60	371	52480	FFC 2/38-40	451
46335	SXR 10 x 180 FUS	432	48311	NSB 3/40	371	52481	FFC 2/55	451
46336	SXR 10 x 200 FUS	432	48312	NSB 3/50	371	52482	FFC 2/63	451
46337	SXR 10 x 230 FUS	432	48313	NSB 3/60	371	52483	FFC 2/75	451
46338	SXR 10 x 260 FUS	432	48323	EA II M 8 x 40	416	52486	FFC 2/82	451
46339	SXR 10 x 60 FUS R	432	48332	EA II M 10 x 30	416	52487	FFC 2/90	451
46340	SXR 10 x 80 FUS R	432	48339	EA II M 10 x 40	416	52488	FFC 2/110	451

Art.-No.	Article	Page	Art.-No.	Article	Page	Art.-No.	Article	Page
52489	FFC 2/125	451	60170	BSMD 18	377	60768	FZA 22 x 125 M16/60 R	410
52500	FFC 2/160	451	60171	BSMD 20	377	60769	FZA 22 x 125 M12 I	411
52501	FFC 2/200	451	60172	BSMD 22	377	60770	FZA 22 x 125 M12 I R	411
53011	FIAM 310	449	60175	BSMD 28	377	60772	FZA 10 x 40 M 6/10 R	410
53081	2K PU 400 (DE)	439	60178	BSMD 37	377	60774	FZA 12 x 50 M 8/50 R	410
53085	PUR 500	443	60185	AM 8	375	60775	FZA 12 x 40 M 8/15 R	410
53090	DBSA TP (DE/EN)	441	60186	AM 10	375	60776	FZA 12 x 50 M 8/15 R	410
53091	DBSA W (DE/EN)	441	60187	AM 12	375	60778	FZA 14 x 40 M10/25 R	410
53092	DBSA GR (DE/EN)	441	60188	AM 14	375	60779	FZA 14 x 60 M10/25 R	410
53094	DBSA SW (DE/EN)	441	60189	AM 16	375	60781	FZA 18 x 80 M12/25 R	410
53100	DSSA TP (DE/EN)	440	60190	AM 18	375	60782	FZA 22 x 100 M16/60 R	410
53101	DSSA W (DE/EN)	440	60191	AM 20	375	60783	FZA 12 x 40 M 6 I R	411
53102	DSSA GR (DE/EN)	440	60192	AM 22	375	60784	FZA 12 x 50 M 6 I R	411
53103	DSSA BG (DE/EN)	440	60193	AM 24	375	60786	FZA 14 x 60 M 8 I R	411
53105	DSSA DG (DE/EN)	440	60194	AM 26	375	60787	FZA 18 x 80 M10 I R	411
53115	KP M1	444	60195	AM 28	375	60788	FZA 22 x 100 M12 I R	411
53117	KP M2	449	60196	AM 30	375	62400	PUP K2 PLUS	443
53120	DSSA SW (DE/EN)	440	60200	BU M8 MH	399	62754	UX 6 x 35	437
56006	FIAM 600	449	60201	BU M10 MH	399	62756	UX 6 x 35 R	437
58120	RC IEC 16	351	60204	BU M12 MH	399	62757	UX 14 x 75	437
58122	RC IEC 20	351	60209	AM 32	375	62758	UX 12 x 70	437
58135	KB 8	363	60210	AM 34	375	63490	FRSH 15 - 19	39
58136	KB 16	363	60211	AM 37	375	63492	FRSH 20 - 24	39
58139	SHA 15	365	60561	WCN 1	395	63494	FRSH 25 - 30	39
58140	SHA 30	365	60562	WCN 2	395	63495	FRSH 32 - 37	39
58141	SHA MS	365	60564	S 8 D 70 WCR	395	63498	FRSH 40 - 45	39
58142	SHA KP	365	60568	S 8 RD 80 WCR	395	63499	FRSH 48 - 53	39
58155	SF plus LS 3/13	359	60570	S 8 RD 60 WCR	395	63500	FRSH 54 - 59	39
58156	SF plus LS 8/28	359	60652	FZA 12 x 50 M 8 D/10	410	63502	FRSH 60 - 64	39
58157	SF plus LS 20/40	359	60653	FZA 12 x 60 M 8 D/10	410	63504	FRSH 68 - 73	39
58173	NS 7	373	60654	FZA 12 x 80 M 8 D/30	410	63505	FRSH 74 - 78	39
58174	NS 8	373	60657	FZA 14 x 80 M10 D/20	410	63511	FRSH 80 - 86	39
58175	NS 9	373	60658	FZA 14 x 100 M10 D/40	410	63513	FRSH 87 - 92	39
58176	NS 10	373	60663	FZA 22 x 125 M16 D/25	410	63518	FRSH 95 - 103	39
58177	NS 12	373	60664	FZA 12 x 50 M 8 D/10 R	410	63520	FRSH 102 - 116	39
58178	SF plus SD 30	361	60665	FZA 12 x 60 M 8 D/10 R	410	63537	FRSH 133 - 141	39
58179	SF plus SD 40	361	60666	FZA 12 x 80 M 8 D/30 R	410	63559	WK 100/100	137
58183	SF plus ES 28	359	60669	FZA 14 x 80 M10 D/20 R	410	63938	UHR5	144
58184	SF plus ZS 10	359	60670	FZA 14 x 100 M10 D/40 R	410	64037	PDH M 12	171
58194	RC IEC 12	351	60672	FZA 18 x 100 M12 D/20 R	410	64038	GLL 3/4"	167
58198	RC IEC 25	351	60673	FZA 18 x 130 M12 D/50 R	410	64041	GL 3/4"	167
58199	RC IEC 32	351	60675	FZA 22 x 125 M16 D/25 R	410	64055	TKL L M 8	201
58200	RC IEC 40	351	60684	FZA 18 x 100 M12 D/20	410	64056	G 12/3	156
58530	DSSA SG (DE/EN)	440	60685	FZA 18 x 130 M12 D/50	410	64056	G 12/3	204
59389	KD W 290ML	441	60712	FZA 10 x 40 M 6/10	410	64090	SPS M 12	158
60012	SCH 812	355	60715	FZA 12 x 40 M 8/15	410	64090	SPS M 12	213
60016	SCH 1216	355	60716	FZA 12 x 50 M 8/15	410	64091	BLR 100 M12	158
60023	SCH 1623	355	60718	FZA 14 x 40 M10/25	410	64091	BLR 100 M12	213
60032	SCH 2332	355	60719	FZA 14 x 60 M10/25	410	64093	G 1/2"	204
60042	SCH 3242	355	60721	FZA 18 x 80 M12/25	410	64094	TZ M 8	193
60149	BSM 16	377	60724	FZA 22 x 100 M16/60	410	64095	TZ M 10	193
60150	BSM 18	377	60725	FZA 22 x 125 M16/60	410	64290	FRS 3/8" A2	328
60151	BSM 20	377	60758	FZA 12 x 40 M 6 I	411	64536	FRS 1/2" A2	328
60152	BSM 22	377	60760	FZA 14 x 60 M 8 I	411	64639	FRS 3/4" A2	328
60153	BSM 24	377	60761	FZA 18 x 80 M10 I	411	64646	FRS 1" A2	328
60155	BSM 28	377	60763	FZA 22 x 100 M12 I	411	64669	FRS 1 1/4" A2	328
60158	BSM 37	377	60766	FZA 14 x 60 M10/50 R	410	64673	FRS 1 1/2" A2	328
60169	BSMD 16	377	60767	FZA 18 x 80 M12/55 R	410	64674	FRS 54 - 58 A2	328

Art.-No.	Article	Page	Art.-No.	Article	Page	Art.-No.	Article	Page
64675	FRS 2" A2	328	70004	SX 4 x 20	438	77937	FABS	409
64688	FRS 67 - 71 A2	328	70005	SX 5 x 25	438	78177	BS ø 8	445
64689	FRS 2 1/2" A2	328	70006	SX 6 x 30	438	78178	BS ø 10	445
64693	FRS 81 - 86 A2	328	70008	SX 8 x 40	438	78179	BS ø 12	445
64694	FRS 3" A2	328	70010	SX 10 x 50	438	78180	BS ø 14	445
64695	FRS 95 - 103 A2	328	70012	SX 12 x 60	438	78181	BS ø 16/18	445
64697	FRS 4" A2	328	70014	SX 14 x 70	438	78182	BS ø 24	445
64709	FRS 121 - 127 A2	328	70016	SX 16 x 80	438	78183	BS ø 28	445
64713	FRS 133 - 141 A2	328	70021	SX 6 x 30 S/10	438	78184	BS ø 30/32/35	445
64714	FRS 159 - 168 A2	328	70022	SX 8 x 40 S/20	438	78185	SX 6 x 50 R	438
64864	FRS 3/8" A4	328	71269	FSB 45°	147	79194	RC IEC 50	351
64865	FRS 1/2" A4	328	72094	UX 6 x 50	437	79196	RC IEC 63	351
64866	FRS 3/4" A4	328	72095	UX 6 x 50 R	437	79400	FGRS Plus 12 - 14	25
64868	FRS 1" A4	328	77347	FUS 41/2,5 - 3 m	99	79401	FGRS Plus 15 - 19	25
64869	FRS 1 1/4" A4	328	77347	FUS 41/2,5 - 3 m	155	79402	FGRS Plus 20 - 24	25
64870	FRS 1 1/2" A4	328	77349	FUS 21/2,5 - 3 m	99	79403	FGRS Plus 25 - 30	25
64873	FRS 54 - 58 A4	328	77355	FEC 41 B	112	79404	FGRS Plus 32 - 37	25
64874	FRS 2" A4	328	77355	FEC 41 B	159	79405	FGRS Plus 40 - 44	25
64875	FRS 67 - 71 A4	328	77355	FEC 41 B	243	79406	FGRS Plus 45 - 50	25
64879	FRS 2 1/2" A4	328	77357	FEC 21 B	112	79407	FGRS Plus 50 - 55	25
64892	FRS 81 - 86 A4	328	77357	FEC 21 B	159	79408	FGRS Plus 56 - 63	25
64893	FRS 3" A4	328	77357	FEC 21 B	243	79413	RDM M 10 / M 8	217
64894	FRS 95 - 103 A4	328	77359	FCA 41 - 300	107	79414	RDM M 12 / M 10	217
64898	FRS 4" A4	328	77361	FCA 41 - 450	107	79415	SKS 8 x 16	214
64899	FRS 121 - 127 A4	328	77363	FCA 41 - 600	107	79416	SKS 10 x 20	214
64901	FRS 133 - 141 A4	328	77365	FCA 41 - 750	107	79417	SKS 10 x 30	214
64903	FRS 159 - 168 A4	328	77405	FCN 6	133	79420	FGRS 12 - 14	27
65132	STS 8 x 80 A2	336	77407	FCN 8	133	79421	FGRS 15 - 19	27
65153	STS 10 x 100 A2	336	77409	FCN 10	133	79422	FGRS 20 - 24	27
65173	G 10 A2	337	77411	FCN 12	133	79423	FGRS 25 - 30	27
65174	G 10 A4	337	77411	FCN 12	160	79424	FGRS 32 - 37	27
68012	SCH 812 GR	355	77537	FUS 41/2,5 - 6 m	99	79425	FGRS 40 - 44	27
68016	SCH 1216 GR	355	77537	FUS 41/2,5 - 6 m	155	79426	FGRS 45 - 50	27
68019	SCH 1619 GR	355	77541	FUS 21/2,5 - 6 m	99	79427	FGRS 50 - 55	27
68023	SCH 1623 GR	355	77580	G 3/4"	204	79428	FGRS 56 - 63	27
68032	SCH 2332 GR	355	77605	TKL L Ø 9	201	79430	FGRS Plus 12 - 14 M8/M10	25
68060	FC 6 - 9 GR	353	77606	GRD 3/4" / M 12	217	79431	FGRS Plus 15 - 19 M8/M10	25
68062	FC 9 - 12 GR	353	77607	GRD 3/4" / M 10	217	79432	FGRS Plus 20 - 24 M8/M10	25
68064	FC 12 - 16 GR	353	77608	GRD 1/2" / M 12	217	79433	FGRS Plus 25 - 30 M8/M10	25
68066	FC 16 - 20 GR	353	77609	GRD 1/2" / M 10	217	79434	FGRS Plus 32 - 37 M8/M10	25
68267	PDH K M 8	171	77611	SKS 12 x 55	214	79435	FGRS Plus 40 - 44 M8/M10	25
68269	PDH K M 10	171	77613	LRBN	191	79436	FGRS Plus 45 - 50 M8/M10	25
69019	SCH 1619	355	77643	STS 8 x 100 A2	336	79437	FGRS Plus 50 - 55 M8/M10	25
69363	UBN 2,6 x 160	385	77644	G 8 A2	337	79438	FGRS Plus 56 - 63 M8/M10	25
69364	UBN 3,6 x 300	385	77645	G 8 A4	337	79440	FRS Plus 12 - 15	31
69365	UBN 4,5 x 160	385	77689	STST 10 x 60	208	79441	FRS Plus 15 - 19	31
69366	UBN 4,8 x 178	385	77707	STST 10 x 80	208	79442	FRS Plus 20 - 24	31
69367	UBN 4,8 x 250	385	77708	STST 10 x 100	208	79443	FRS Plus 25 - 30	31
69368	UBN 4,8 x 350	385	77709	STST 10 x 120	208	79444	FRS Plus 32 - 37	31
69369	UBN 4,8 x 370	385	77711	STST 10 x 140	208	79445	FRS Plus 40 - 45	31
69370	UBN 4,8 x 430	385	77712	STST 10 x 180	208	79446	FRS Plus 48 - 54	31
69372	UBN 7,8 x 180	385	77714	STST 6 x 80	208	79447	FRS Plus 55 - 61	31
69373	UBN 7,8 x 300	385	77715	STS 8 x 100 A4	336	79449	FRS Plus 63 - 67	31
69374	UBN 7,6 x 450	385	77716	STS 10 x 100 A4	336	79450	FRS Plus 68 - 73	31
69375	UBN 7,6 x 550	385	77869	UX 8 x 50	437	79451	FRS Plus 72 - 80	31
69376	UBN 8,8 x 760	385	77870	UX 8 x 50 R	437	79452	FRS Plus 80 - 86	31
69377	UBN 8,8 x 810	385	77871	UX 10 x 60	437	79453	FRS Plus 87 - 92	31
69379	UBN 8,8 x 1168	385	77872	UX 10 x 60 R	437	79454	FRS Plus 95 - 103	31

Art.-No.	Article	Page	Art.-No.	Article	Page	Art.-No.	Article	Page
79455	FRS Plus 108 - 116	31	79685	SBS M 8	168	79782	STST 8 x 80	208
79456	FRS 121 - 128 M8/M10	37	79686	SBS M 10	168	79783	STST 8 x 100	208
79457	FRS 133 - 141 M8/M10	37	79687	TKL M 8	201	79784	STST 8 x 120	208
79458	FRS 159 - 165 M8/M10	37	79688	TKL M 10	201	79785	STST 8 x 140	208
79459	FRS 165 - 168 M8/M10	37	79689	TKL Ø 11	201	79786	STST 8 x 180	208
79470	FKS Plus 15 - 19	29	79690	VM M 8	215	79815	ED 18	223
79471	FKS Plus 20 - 24	29	79691	VM M 10	215	79815	ED 18	383
79472	FKS Plus 25 - 30	29	79692	RD M 10 / M 8	217	79825	TZH M 8	193
79473	FKS Plus 32 - 37	29	79693	RD M 12 / M 10	217	79826	TZH M 10	193
79474	FKS Plus 40 - 44	29	79695	RD 1/2" / M10	217	79827	SKS 8 x 100	214
79475	FKS Plus 45 - 50	29	79696	AG 8 x 20	216	79829	LST 10	194
79476	FKS Plus 50 - 55	29	79697	AG 10 x 25	216	79830	LZ	194
79477	FKS Plus 56 - 63	29	79698	RAH M 8	216	80650	WL 10 x 80	399
79491	LGS 80	187	79699	RAH M 10	216	80651	WL 7 x 60	399
79492	LGS 90	187	79700	LLS 6 x 50	218	80652	WL 8 x 70	399
79493	LGS 100	187	79701	LLS 8 x 50	218	80654	BO 120	398
79494	LGS 112	187	79702	DPP 65	212	80655	WD 10 x 120	398
79495	LGS 125	187	79703	DPP 85	212	80656	WD 10 x 140	398
79496	LGS 140	187	79704	DPP 105	212	80658	WD 8 x 110	398
79497	LGS 150	187	79705	SBB 35	213	80659	WD 8 x 90	398
79498	LGS 160	187	79706	SBB 45	213	80660	WST 10 x 140	398
79499	LGS 180	187	79707	SBB 55	213	80661	WST 12 x 150	398
79500	LGS 200	187	79711	SKS 6 x 20	214	80662	WST 12 x 180	398
79501	LGS 224	187	79713	SKS 8 x 30	214	80668	UST 10 x 120	399
79502	LGS 250	187	79714	SKS 8 x 45	214	80951	AKM 10 CR	399
79503	LGS 280	187	79715	SKS 8 x 55	214	80952	AKM 12 CR	399
79504	LGS 300	187	79717	MW M 8	210	80972	AKM 10 W	399
79505	LGS 315	187	79721	SKS 10 x 55	214	83578	UST 8 x 110	399
79506	LGS 355	187	79725	U 8 x 28	214	87478	BN 2,5 x 100	385
79507	LGS 400	187	79726	U 10 x 28	214	87479	BN 2,5 x 120	385
79535	BSMZ 20	377	79729	U 8 x 40	214	87480	BN 2,5 x 200	385
79536	BSMZ 24	377	79730	U 10 x 40	214	87481	BN 3,6 x 150	385
79537	BSMZ 28	377	79733	MU M 6	215	87484	BN 4,6 x 200	385
79549	LBV 12	221	79734	MU M 8	215	87485	BN 4,8 x 280	385
79549	LBV 12	381	79735	MU M 10	215	87487	BN 7,6 x 350	385
79550	LBV 17	221	79740	G 8	204	87488	UBN 2,5 x 100	385
79550	LBV 17	381	79741	G 8/2	204	87489	UBN 2,5 x 120	385
79551	LBV 25	221	79744	G 10	204	87490	UBN 2,5 x 200	385
79551	LBV 25	381	79745	G 10/2	204	87491	UBN 3,6 x 150	385
79553	LBK 14	221	79750	GS 8/25	204	87494	UBN 4,6 x 200	385
79553	LBK 14	381	79751	GS 8/40	204	87495	UBN 4,8 x 280	385
79554	LBK 19	221	79752	GS 8/50	204	87497	UBN 7,6 x 350	385
79554	LBK 19	381	79753	GS 8/60	204	89300	Blow-out pump AB G	444
79555	LBK 27	221	79754	GS 8/70	204	90243	FIS A M 6 x 75	427
79555	LBK 27	381	79755	GS 8/80	204	90272	FIS A M 6 x 85	427
79570	WK 200/200	137	79757	GS 8/100	204	90273	FIS A M 6 x 110	427
79571	WK 207/165	137	79758	GS 8/150	204	90274	FIS A M 8 x 90	426
79665	GPL M 8	206	79759	GS 8/200	204	90275	FIS A M 8 x 110	426
79666	GPL M 10	206	79765	GS 10/25	205	90276	FIS A M 8 x 130	426
79667	GPL 1/2"	206	79766	GS 10/40	205	90277	FIS A M 8 x 175	426
79671	GPS M 10	206	79767	GS 10/60	205	90278	FIS A M 10 x 110	426
79672	GPS 1/2"	206	79768	GS 10/80	205	90279	FIS A M 10 x 130	426
79675	AHB	209	79769	GS 10/100	205	90281	FIS A M 10 x 150	426
79676	PDH M 8	171	79770	GS 10/120	205	90282	FIS A M 10 x 200	426
79677	PDH M 10	171	79771	GS 10/150	205	90283	FIS A M 12 x 140	426
79678	PV M 8	211	79772	GS 10/200	205	90284	FIS A M 12 x 160	426
79680	SB M 8	170	79780	STST 8 x 50	208	90285	FIS A M 12 x 180	426
79681	SB M 10	170	79781	STST 8 x 60	208	90286	FIS A M 12 x 210	426

Art.-No.	Article	Page	Art.-No.	Article	Page	Art.-No.	Article	Page
90287	FIS A M 12 x 260	426	91505	FRS 87 - 92 M8/M10	37	96297	FAZ II 10/30 GS	408
90288	FIS A M 16 x 175	426	91506	FRS 108 - 116 M8/M10	37	96303	FAZ II 12/10 GS	408
90289	FIS A M 16 x 200	426	91507	FRSH 159 - 168	39	96340	FAZ II 12/30 GS	408
90290	FIS A M 16 x 250	426	92295	FUS 41/2,5 - 2 m	99	96367	FAZ II 12/120 GS	408
90291	FIS A M 16 x 300	426	92867	FUS 21/2,5 - 2 m	99	96370	FAZ II 16/200 GS	409
90292	FIS A M 20 x 245	426	92960	FCSN M 8 x 30	132	96497	FIS AC	444
90293	FIS A M 20 x 290	426	92961	FCSN M 8 x 40	132	96824	FHB II-P 8 x 60	422
90294	FIS A M 24 x 290	426	93354	FCSN M 8 x 50	132	96843	FHB II-P 10 x 95	422
90295	FIS A M 24 x 380	426	93355	FCSN M 8 x 60	132	96844	FHB II-P 12 x 120	422
90297	FIS A M 30 x 430	426	93360	FCSN M 10 x 30	132	96845	FHB II-P 16 x 160	422
90437	FIS A M 6 x 75 R	427	93361	FCSN M 10 x 40	132	96846	FHB II-P 20 x 210	422
90439	FIS A M 6 x 110 R	427	93362	FCSN M 10 x 50	132	96847	FHB II-P 10 x 60	422
90440	FIS A M 8 x 90 R	426	93363	FCSN M 10 x 60	132	96848	FHB II-P 12 x 75	422
90441	FIS A M 8 x 110 R	426	93366	FCSN M 12 x 30	132	96849	FHB II-P 16 x 95	422
90442	FIS A M 8 x 130 R	426	93367	FCSN M 12 x 40	132	96851	FHB II-P 24 x 170	422
90443	FIS A M 8 x 175 R	426	93709	FRSM 124 - 129 M10/M12	47	96907	FHB II-A L M10 x 95/10	424
90444	FIS A M 10 x 110 R	426	93710	FRSM 131 - 137 M10/M12	47	96940	FHB II-A L M10 x 95/20	424
90447	FIS A M 10 x 130 R	426	93711	FRSM 138 - 145 M10/M12	47	96941	FHB II-A L M10 x 95/60	424
90448	FIS A M 10 x 150 R	426	93712	FRSM 156 - 162 M10/M12	47	96942	FHB II-A L M10 x 95/100	424
90449	FIS A M 10 x 200 R	426	93713	FRSM 165 - 171 M10/M12	47	96943	FHB II-A L M12 x 120/10	424
90450	FIS A M 12 x 140 R	426	93714	FRSM 188 - 194 M10/M12	47	96944	FHB II-A L M12 x 120/25	424
90451	FIS A M 12 x 160 R	426	93715	FRSM 196 - 203 M10/M12	47	96958	BSM 26	377
90452	FIS A M 12 x 180 R	426	94673	MNS 4-7	373	97014	FHB II-A L M12 x 120/60	424
90453	FIS A M 12 x 210 R	426	94674	MNS 7-11	373	97031	FHB II-A L M12 x 120/100	424
90454	FIS A M 12 x 260 R	426	94675	MNS 10-14	373	97032	FHB II-A L M8 x 60/10	424
90455	FIS A M 16 x 175 R	426	94721	UX 5 x 30	437	97033	FHB II-A L M8 x 60/30	424
90456	FIS A M 16 x 200 R	426	94722	UX 5 x 30 R	437	97034	FHB II-A L M8 x 60/50	424
90457	FIS A M 16 x 250 R	426	94758	UX 6 x 35 R S	437	97035	FHB II-A L M16 x 160/30	425
90458	FIS A M 16 x 300 R	426	94759	UX 6 x 50 R S	437	97038	FHB II-A L M16 x 160/60	425
90459	FIS A M 20 x 245 R	426	94760	UX 8 x 50 R S	437	97070	FHB II-A L M16 x 160/100	425
90460	FIS A M 20 x 290 R	426	94761	UX 10 x 60 S	437	97071	FHB II-A L M20 x 210/50	425
90461	FIS A M 24 x 290 R	426	94762	UX 8 x 50 R S/15	437	97072	FHB II-A S M10 x 60/10	423
90462	FIS A M 24 x 380 R	426	94871	FAZ II 8/10	405	97073	FHB II-A S M10 x 60/20	423
90464	FIS A M 30 x 430 R	426	94872	FAZ II 8/10 GS	408	97074	FHB II-A S M10 x 60/60	423
90839	BSM 25	377	94877	FAZ II 8/30	405	97206	FHB II-A S M10 x 60/100	423
90840	BSM 32	377	94878	FAZ II 8/50	405	97257	FHB II-A S M12 x 75/10	423
90841	BSM 40	377	94879	FAZ II 8/100	405	97268	FHB II-A S M12 x 75/25	423
90842	BSM 50	378	94981	FAZ II 10/10	405	97274	FHB II-A S M12 x 75/60	424
90843	BSM 63	378	94982	FAZ II 10/20	405	97275	FHB II-A S M12 x 75/100	424
90844	BSMD 25	377	94983	FAZ II 10/30	405	97280	FHB II-A S M12 x 75/165	424
90845	BSMD 32	377	94984	FAZ II 10/50	405	97281	FHB II-A S M16 x 95/30	424
90846	BSMD 40	377	94985	FAZ II 10/80	405	97286	FHB II-A S M16 x 95/60	424
90847	BSMD 50	378	94986	FAZ II 10/100	405	97295	FHB II-A S M16 x 95/100	424
90848	BSMD 63	378	95419	FAZ II 12/10	405	97296	FHB II-A S M16 x 95/165	424
90849	AM 40	375	95420	FAZ II 12/20	405	97297	FHB II-A S M24 x 170/50	424
90850	AM 50	375	95421	FAZ II 12/30	405	97298	FHB II-A L M8 x 60/10 R	424
90851	AM 63	375	95446	FAZ II 12/50	405	97299	FHB II-A L M8 x 60/30 R	424
91442	GS 12/40	205	95454	FAZ II 12/80	405	97440	FHB II-A L M8 x 60/50 R	424
91443	GS 12/60	205	95470	FAZ II 12/100	405	97616	FHB II-A L M10 x 95/10 R	424
91444	GS 12/80	205	95605	FAZ II 12/200	405	97617	FHB II-A L M10 x 95/20 R	424
91461	GS 12/100	205	95836	FAZ II 16/25	406	97618	FHB II-A L M10 x 95/40 R	424
91462	GS 12/120	205	95864	FAZ II 16/50	406	97619	FHB II-A L M10 x 95/60 R	424
91463	GS 12/150	205	95865	FAZ II 16/100	406	97620	FHB II-A L M10 x 95/100 R	424
91464	GS 12/200	205	95967	FAZ II 16/200	406	97621	FHB II-A L M12 x 120/10 R	424
91477	U 8 x 17	214	95968	FAZ II 16/250	406	97622	FHB II-A L M12 x 120/25 R	424
91478	U 10 x 21	214	96188	FAZ II 16/300	406	97623	FHB II-A L M12 x 120/40 R	424
91488	FRS 63 - 67 M8/M10	37	96189	FAZ II 8/30 GS	408	97624	FHB II-A L M12 x 120/60 R	424
91489	FRS 72 - 80 M8/M10	37	96291	FAZ II 10/10 GS	408	97625	FHB II-A L M12 x 120/100 R	424

Art.-No.	Article	Page	Art.-No.	Article	Page	Art.-No.	Article	Page
97626	FHB II-A L M16 x 160/30 R	425	500706	FRS Triple 74 - 80	35	501427	FAZ II 24/30 R	406
97627	FHB II-A L M16 x 160/60 R	425	500707	FRS Triple 83 - 91	35	501428	FAZ II 8/10 HCR	405
97628	FHB II-A L M16 x 160/100 R	425	500708	FRS Triple 100 - 105	35	501429	FAZ II 8/30 HCR	405
97629	FHB II-A L M20 x 210/50 R	425	500709	FRS Triple 108 - 114	35	501430	FAZ II 10/10 HCR	405
97630	FHB II-A S M10 x 60/10 R	423	500710	FRS Triple 115 - 125	35	501431	FAZ II 12/30 HCR	405
97631	FHB II-A S M10 x 60/20 R	423	500711	FRS Triple 127 - 135	35	501432	FAZ II 16/25 HCR	406
97632	FHB II-A S M10 x 60/40 R	423	500712	FRS Triple 135 - 140	35	502456	SXR 10 x 52 FUS	432
97633	FHB II-A S M10 x 60/60 R	423	500713	FRS Triple 159 - 169	35	502530	FAZ II 12/20 GS	408
97634	FHB II-A S M10 x 60/100 R	423	500714	FRSN Triple 15 - 19	41	502531	FAZ II 12/50 GS	408
97635	FHB II-A S M12 x 75/10 R	423	500715	FRSN Triple 21 - 23	41	502532	FAZ II 12/100 GS	408
97636	FHB II-A S M12 x 75/25 R	423	500716	FRSN Triple 26 - 28	41	503180	FAZ II 12/160 R	405
97637	FHB II-A S M12 x 75/40 R	424	500717	FRSN Triple 32 - 35	41	503181	FAZ II 12/160 GS R	408
97638	FHB II-A S M12 x 75/60 R	424	500718	FRSN Triple 40 - 43	41	503182	FAZ II 16/160 GS R	409
97639	FHB II-A S M12 x 75/100 R	424	500719	FRSN Triple 48 - 56	41	503183	FAZ II 20/60 R	406
97640	FHB II-A S M12 x 75/165 R	424	500720	FRSN Triple 57 - 62	41	503184	FAZ II 24/60 R	406
97641	FHB II-A S M16 x 95/30 R	424	500721	FRSN Triple 63 - 70	41	503185	FAZ II 10/30 HCR	405
97642	FHB II-A S M16 x 95/60 R	424	500722	FRSN Triple 74 - 80	41	503186	FAZ II 12/10 HCR	405
97643	FHB II-A S M16 x 95/100 R	424	500723	FRSN Triple 83 - 91	41	503187	FAZ II 16/50 HCR	406
97644	FHB II-A S M16 x 95/165 R	424	500724	FRSN Triple 100 - 105	41	503251	FAZ II 8/160	405
97645	FHB II-A S M24 x 170/50 R	424	500725	FRSN Triple 108 - 114	41	503252	FAZ II 10/160	405
97658	FUS 41/2,0 - 3 m	99	500744	FRSN 118 - 122 M8/M10	43	503253	FAZ II 12/160	405
97658	FUS 41/2,0 - 3 m	155	500746	FRSN 146 - 156 M8/M10	43	503254	FAZ II 16/160	406
97659	FUS 41/2,0 - 6 m	99	500747	FRSN 159 - 165 M10/M12	43	503255	FAZ II 20/160	406
97659	FUS 41/2,0 - 6 m	155	500748	FRSN 166 - 175 M10/M12	43	503261	FAZ II 16/160 GS	409
97660	FUS 21/2,0 - 3 m	99	500751	FRSN 200 - 206 M10/M12	43	503317	KDC CRYSTAL CLEAR 290ML	441
97661	FUS 21/2,0 - 6 m	99	500752	FRSN 210 - 219 M10/M12	43	503318	KD GR 290ML	441
97696	FHB II-A L M8 x 60/10 HCR	424	501261	SCN 16	349	503319	KD SW 290ML	441
97699	FHB II-A L M10 x 95/20 HCR	424	501262	SCN 20	349	504315	FCA 62 - 1000	107
97700	FHB II-A L M12 x 120/25 HCR	424	501263	SCN 25	349	504317	FCA 41D - 750	108
97702	FHB II-A L M16 x 160/30 HCR	425	501264	SCN 32	349	504319	FCA 41D - 1000	108
97703	FHB II-A L M20 x 210/50 HCR	425	501265	SCN 40	349	504320	FHS CLIX S 12 x 60	130
97704	FHB II-A S M10 x 60/10 HCR	423	501266	SCN 50	349	504326	FCN Clix P 6	128
97706	FHB II-A S M12 x 75/25 HCR	423	501396	FAZ II 8/10 R	405	504327	FCN Clix P 8	128
97708	FHB II-A S M16 x 95/30 HCR	424	501398	FAZ II 8/10 GS R	408	504329	FCN Clix P 10	128
97967	Applicator gun 600 ml	449	501399	FAZ II 8/30 R	405	504331	FCN Clix P 12	128
98011	PU 1/750 B3 HandHeld (EN/FR)	440	501400	FAZ II 8/30 GS R	408	504331	FCN Clix P 12	159
98012	PUP 750 B3 GunGrade (EN/FR)	439	501401	FAZ II 8/50 R	405	504344	FCN Clix M 6	128
500542	FHB II-PF 8 x 60	423	501403	FAZ II 10/10 R	405	504345	FCN Clix M 8	128
500543	FHB II-PF 10 x 95	423	501405	FAZ II 10/10 GS R	408	504346	FCN Clix M 10	128
500544	FHB II-PF 12 x 120	423	501406	FAZ II 10/20 R	405	504347	FCN Clix M 12	128
500545	FHB II-PF 16 x 160	423	501407	FAZ II 10/30 R	405	504355	SF L 41	135
500546	FHB II-PF 20 x 210	423	501408	FAZ II 10/30 GS R	408	504357	SF L 82	135
500547	FHB II-PF 10 x 60	423	501409	FAZ II 10/50 R	405	504358	SF L 124	135
500548	FHB II-PF 12 x 75	423	501410	FAZ II 10/70 R	405	504363	TKR 21 - 42	148
500549	FHB II-PF 16 x 95	423	501411	FAZ II 10/100 R	405	504366	TKR 82	148
500550	FHB II-PF 24 x 170	423	501412	FAZ II 10/160 R	405	504367	TKR 124	148
500569	FNA II 6 x 30/50 HCR	418	501413	FAZ II 12/10 R	405	504367	TKR 124	158
500573	FNA II 6 x 30/75 HCR	418	501414	FAZ II 12/10 GS R	408	504368	FFF 4D	139
500574	FNA II 6 x 30/100 HCR	418	501415	FAZ II 12/20 R	405	504375	FZF 21	141
500575	FNA II 6 x 30/120 HCR	418	501416	FAZ II 12/30 R	405	504376	FUF 21	141
500698	FRS Triple 15 - 19	35	501418	FAZ II 12/30 GS R	408	504377	FUF 41	141
500699	FRS Triple 21 - 23	35	501419	FAZ II 12/50 R	405	504378	FUF 4Y	142
500700	FRS Triple 26 - 28	35	501420	FAZ II 12/60 R	405	504379	FUF 180°L	142
500701	FRS Triple 32 - 35	35	501421	FAZ II 12/100 R	405	504383	FUF 180°R	142
500702	FRS Triple 40 - 43	35	501423	FAZ II 16/25 R	406	504387	FUF 8T	142
500703	FRS Triple 48 - 56	35	501424	FAZ II 16/50 R	406	504397	RD M 12 / M 16	217
500704	FRS Triple 57 - 62	35	501425	FAZ II 16/100 R	406	504399	RD M 16 / M 12	217
500705	FRS Triple 63 - 70	35	501426	FAZ II 20/30 R	406	504400	STST 6 x 60	208

Art.-No.	Article	Page	Art.-No.	Article	Page	Art.-No.	Article	Page
504408	GPS M 16	206	505580	KFT 18,0	51	506506	FRS K 76/19	49
504457	FUS 62/2,5 - 6 m	99	505581	KFT 19,5	51	506508	FRS K 89/19	49
504457	FUS 62/2,5 - 6 m	155	505582	KFT 21,3	51	506509	FRS K 102/19	49
504458	FUS 21D/2,0 - 3 m	99	505583	KFT 22,0	51	506510	FRS K 108/19	49
504458	FUS 21D/2,0 - 3 m	155	505584	KFT 26,9	51	506511	FRS K 114/19	49
504459	FUS 41D/2,5 - 6 m	99	505585	KFT 28,0	51	506884	FHB II-A S M10 x 75/10	423
504459	FUS 41D/2,5 - 6 m	155	505587	KFT 33,7	51	506885	FHB II-A S M10 x 75/20	423
504460	FUS 62D/2,5 - 6 m	99	505588	KFT 35,0	51	506886	FHB II-A S M10 x 75/60	423
504460	FUS 62D/2,5 - 6 m	155	505589	KFT 40,0	51	506887	FHB II-A S M10 x 75/100	423
504466	FUS 21/2,0 A2 - 2 m	329	505591	KFT 41,2	51	506888	FHB II-A S M10 x 75/10 R	423
504468	FUS 41/2,0 A2 - 2 m	329	505592	KFT 42,4	51	506889	FHB II-A S M10 x 75/20 R	423
504470	FUS 41/2,5 A2 - 2 m	329	505593	KFT 44,5	51	506890	FHB II-A S M10 x 75/40 R	423
504472	FUS 21/2,0 A4 - 2 m	329	505594	KFT 48,3	51	506891	FHB II-A S M10 x 75/60 R	423
504474	FUS 41/2,0 A4 - 2 m	329	505595	KFT 50,0	51	506892	FHB II-A S M10 x 75/100 R	423
504475	FUS 41/2,5 A4 - 2 m	329	505596	KFT 54,0	51	506893	FHB II-A L M12 x 100/10	424
504476	TKR 21 - 42 A4	335	505597	KFT 57,0	51	506894	FHB II-A L M12 x 100/25	424
504477	FCAM 300	111	505598	KFT 60,3	51	506895	FHB II-A L M12 x 100/60	424
504479	FCAM 400	111	505599	KFT 64,0	51	506896	FHB II-A L M12 x 100/100	424
504480	FCAM 500	111	505901	KFT 70,0	51	506897	FHB II-A L M12 x 100/10 R	424
504482	FCAM 600	111	505902	KFT 74,0	51	506898	FHB II-A L M12 x 100/25 R	424
504498	FFF 3L	139	505903	KFT 76,1	51	506899	FHB II-A L M12 x 100/40 R	424
504500	FFF 4T	139	505904	KFT 80,0	51	506901	FHB II-A L M12 x 100/60 R	424
504515	FZF 41	141	505905	KFT 84,0	51	506902	FHB II-A L M12 x 100/100 R	424
504517	FUF OC 41	121	505906	KFT 88,9	51	506903	FHB II-A L M16 x 125/30	424
504518	FUF OC 62	121	505907	KFT 92,1	51	506904	FHB II-A L M16 x 125/60	424
504518	FUF OC 62	156	505908	KFT 101,0	51	506905	FHB II-A L M16 x 125/100	424
504522	SF L 41 A4	332	505909	KFT 104,0	51	506906	FHB II-A L M16 x 125/30 R	424
504594	FRSM 348 - 356 M16	47	505910	KFT 108,0	51	506909	FHB II-A L M16 x 125/60 R	424
504595	FRSM 364 - 372 M16	47	505911	KFT 114,3	51	506910	FHB II-A L M16 x 125/100 R	424
504596	FRSM 400 - 409 M16	47	505914	KFT 129,0	51	506911	FHB II-A L M16 x 145/30	425
504597	FRSM 454 - 462 M16	47	505915	KFT 133,0	51	506912	FHB II-A L M16 x 145/60	425
504598	FRSM 500 - 508 M16	47	505916	KFT 139,7	51	506913	FHB II-A L M16 x 145/100	425
505453	FRSM 212 M12/M16	47	505917	KFT 154,0	51	506914	FHB II-A L M16 x 145/30 R	425
505454	FRSM 8" M12/M16	47	505918	KFT 159,0	51	506915	FHB II-A L M16 x 145/60 R	425
505455	FRSM 250 M12/M16	47	505919	KFT 168,3	51	506916	FHB II-A L M16 x 145/100 R	425
505456	FRSM 10" M12/M16	47	505920	KFT 193,7	51	506917	FHB II-A S M20 x 170/50	424
505457	FRSM 300 M12/M16	47	505921	KFT 204,0	52	506919	FHB II-A S M20 x 170/50 R	424
505458	FRSM 12" M12/M16	47	505922	KFT 219,1	52	506920	FHB II-A L M24 x 210/50	425
505460	FCAM 700	111	506486	FRS K 12/13	49	506921	FHB II-A L M24 x 210/50 R	425
505483	UX 8 x 40 R	437	506487	FRS K 15/13	49	507435	LBW 17	221
505487	FCA 41 A4 - 300	329	506488	FRS K 17-18/13	49	507699	FRS K 54/13	49
505488	FCA 41 A4 - 450	329	506489	FRS K 21-22/13	49	507700	FRS K 54/19	49
505489	FCA 41 A4 - 600	329	506490	FRS K 27-28/13	49	507786	FRS K 133/19	49
505542	U 8 x 28 A4	338	506491	FRS K 34-35/13	49	507787	FRS K 139/19	49
505543	U 8 x 40 A4	338	506492	FRS K 42/13	49	507788	FRS K 168/19	49
505544	U 10 x 28 A4	338	506493	FRS K 48-49/13	49	507866	FSC 1	169
505545	U 10 x 40 A4	338	506494	FRS K 60/13	49	507922	FHB II-P 12 x 100	422
505546	U 12 x 24 A4	338	506495	FRS K 12/19	49	507923	FHB II-P 16 x 125	422
505551	FEC 62 B	112	506496	FRS K 15/19	49	507924	FHB II-P 16 x 145	422
505551	FEC 62 B	159	506497	FRS K 17-18/19	49	507925	FHB II-P 20 x 170	422
505551	FEC 62 B	243	506498	FRS K 21-22/19	49	507926	FHB II-P 24 x 210	422
505552	SKS 10 x 85	214	506499	FRS K 27-28/19	49	507999	FHB II-PF 10 x 75	423
505553	SKS 12 x 85	157	506500	FRS K 34-35/19	49	508000	FHB II-PF 12 x 100	423
505553	SKS 12 x 85	214	506501	FRS K 42/19	49	508001	FHB II-PF 16 x 125	423
505576	KFT 9,5	51	506502	FRS K 48-49/19	49	508002	FHB II-PF 16 x 145	423
505577	KFT 12,7	51	506503	FRS K 60/19	49	508003	FHB II-PF 20 x 170	423
505578	KFT 15,8	51	506504	FRS K 64/19	49	508004	FHB II-PF 24 x 210	423
505579	KFT 17,2	51	506505	FRS K 70/19	49	508016	FHB II-P 10 x 75	422

Art.-No.	Article	Page	Art.-No.	Article	Page	Art.-No.	Article	Page
508833	VM M 16	215	514259	TherMax 10/240 M10	434	519393	FIS A M 8 x 175 8.8	426
509214	FIS A M 8 x 1000	426	516537	LKHN	188	519395	FIS A M 10 x 170 8.8	426
509215	FIS A M 10 x 1000	426	516540	ZKHN	189	519396	FIS A M 10 x 200 8.8	426
509216	FIS A M 12 x 1000	426	516662	FRSP 1/2"	54	519397	FIS A M 12 x 120 8.8	426
509217	FIS A M 16 x 1000	426	516663	FRSP 3/4"	54	519398	FIS A M 12 x 140 8.8	426
509223	FIS A M 10 x 1000 8.8	426	516664	FRSP 1"	54	519399	FIS A M 12 x 180 8.8	426
509224	FIS A M 12 x 1000 8.8	426	516665	FRSP 1-1/4"	54	519400	FIS A M 16 x 130 8.8	426
509225	FIS A M 16 x 1000 8.8	426	516666	FRSP 1-1/2"	54	519401	FIS A M 16 x 175 8.8	426
509230	FIS A M 8 x 1000 R	426	516667	FRSP 2"	54	519402	FIS A M 16 x 300 8.8	426
509231	FIS A M 10 x 1000 R	426	516668	FRSP 2-1/2"	54	519404	FIS A M 20 x 245 8.8	426
509232	FIS A M 12 x 1000 R	426	516669	FRSP 3"	54	519406	FIS A M 20 x 290 8.8	426
509233	FIS A M 16 x 1000 R	426	516670	FRSP 4"	54	519410	FIS A M 20 x 1000 8.8	426
509241	FTC-ZA (EN/FR/ES/PT)	443	516671	FRSP 6"	54	519427	FIS A M 20 x 1000 R	426
509242	FTC-ZS (EN/FR/ES/PT)	443	516672	FRSP 8"	54	519450	FIS SB 390 S	425
509537	SXR 10 x 60 FUS hdg	432	516673	RCWR 1/2"	60	519451	FIS SB 390 S	425
509538	SXR 10 x 80 FUS hdg	432	516674	RCWR 3/4"	60	519452	FIS SB 585 S	425
509539	SXR 10 x 100 FUS hdg	432	516675	RCWR 1"	60	519665	FIS HB 150 C	422
509540	SXR 10 x 140 FUS hdg	432	516676	RCWR 1 1/4"	60	519808	FF 8 - 32	357
510969	FRS 12 - 15 M8/M10	37	516677	RCWR 1 1/2"	60	519809	FF 16 - 63	357
510970	FRS 48 - 54 M8/M10	37	516678	RCWR 2"	60	520471	Washer for FBS II 10	415
510992	FIS DM S-L	444	516679	RCWR 3"	60	520526	FIS SB 585 S	425
511118	FIS DM S	444	516680	RCWR 4"	60	520555	FIS SB 390 S	425
512114	SAE 300	177	516681	RCWR 5"	60	520557	FIS SB 390 S	425
512115	SAE 500	177	516682	RCWR 6"	60	520559	FIS SB 390 S	425
512208	DSSA FUG (DE/EN)	440	516683	RCWR 8"	60	520593	FIS UMR	425
512209	DSSA SAG (DE/EN)	440	516695	FCHS 2"	58	520595	FIS SB 390 S	425
512210	DSSA MA (DE/EN)	440	516696	FCHS 2-1/2"	58	521431	FIS V 410 C	427
512211	DSSA AN (DE/EN)	440	516697	FCHS 3"	58	521760	KLIMA EASY KLIK	343
512213	DBSA SLG (DE/EN)	441	516699	FCHS 4"	58	521761	KLIMA KLIK 420	343
512401	FIS DP S-XL	444	516700	FCHS 5"	58	522108	FAZ II 10/10 K	407
512605	TherMax 10/200 M6	434	516701	FCHS 6"	58	522110	FAZ II 10/20 K	407
512715	PA 30 x 30	345	516702	FCHS 8"	58	522115	FAZ II 10/10 K GS	408
512716	FSFP 1"	166	516703	FCHS 10"	58	522116	FAZ II 10/10 K R	407
512717	FSFP 1 1/4"	166	516704	FCHS 12"	58	522117	FAZ II 10/20 K R	407
512718	FSFP 1 1/2"	166	517411	FCA 41 - 300 hdg	239	522118	FAZ II 12/10 K	408
512719	FSFP 2"	166	517412	FCA 41 - 450 hdg	239	522119	FAZ II 12/20 K	408
512720	FSFP 2 1/2"	166	517413	FCA 41 - 600 hdg	239	522121	FAZ II 12/10 K GS	408
512721	FSFP 3"	166	517414	FCA 41 - 750 hdg	239	522122	FAZ II 12/10 K R	408
512722	FSFP 4"	166	517415	FUF OC 41 hdg	237	522123	FAZ II 12/20 K R	408
513302	FRSL 34	56	517420	FCN Clix P 12 hdg	259	522124	FAZ II 16/5	405
513303	FRSL 43	56	517421	SF L 41 hdg	261	522125	FAZ II 16/5 R	406
513304	FRSL 49	56	517426	FUS 41/2,0 - 3 m hdg	233	522517	Setting tool FPX M6 I	421
513307	FRSL 60	56	517427	FUS 62/2,5 - 3 m hdg	233	522518	Setting tool FPX M8-M12 I	421
513308	FRSL 76	56	517428	FUS 62/2,5 - 6 m hdg	233	522719	SXRL 10 x 80 FUS	433
513309	FRSL 90	56	517935	FIS A M 10 x 150 8.8	426	522720	SXRL 10 x 100 FUS	433
513310	FRSL 115	56	517936	FIS A M 10 x 190 8.8	426	522721	SXRL 10 x 120 FUS	433
513311	FRSL 140	56	517937	FIS A M 12 x 160 8.8	426	522723	SXRL 10 x 140 FUS	433
513312	FRSL 170	56	517938	FIS A M 12 x 200 8.8	426	522724	SXRL 10 x 160 FUS	433
513429	PUP M4 BLACK	443	517939	FIS A M 16 x 200 8.8	426	522725	SXRL 10 x 180 FUS	433
514250	TherMax 10/220 M6	434	517940	FIS A M 16 x 250 8.8	426	522726	SXRL 10 x 200 FUS	433
514251	TherMax 10/240 M6	434	518831	FIS SB 390 S	425	522727	SXRL 10 x 230 FUS	433
514252	TherMax 10/180 M8	434	519021	FPX M6-I	421	522728	SXRL 10 x 260 FUS	433
514253	TherMax 10/200 M8	434	519022	FPX M8-I	421	522729	SXRL 10 x 290 FUS	433
514254	TherMax 10/220 M8	434	519023	FPX M10-I	421	522730	SXRL 10 x 80 FUS R	433
514255	TherMax 10/240 M8	434	519024	FPX M12-I	421	522731	SXRL 10 x 100 FUS R	433
514256	TherMax 10/180 M10	434	519390	FIS A M 8 x 90 8.8	426	522732	SXRL 10 x 120 FUS R	433
514257	TherMax 10/200 M10	434	519391	FIS A M 8 x 110 8.8	426	522733	SXRL 10 x 140 FUS R	433
514258	TherMax 10/220 M10	434	519392	FIS A M 8 x 130 8.8	426	522734	SXRL 10 x 160 FUS R	433

10

Art.-No.	Article	Page	Art.-No.	Article	Page	Art.-No.	Article	Page
522735	SXRL 10 x 180 FUS R	433	533736	PFAF 3	123	536858	FBS II 10x60 5/-/- US	412
522736	SXRL 10 x 200 FUS R	433	533737	PFAF 4/135°	123	536859	FBS II 10x70 15/5/- US	412
522737	SXRL 10 x 230 FUS R	433	533738	PFUF 41	125	536860	FBS II 10x80 25/15/- US	412
522738	SXRL 10 x 260 FUS R	433	533739	PFUF 41	114	536861	FBS II 10x90 35/25/5 US	412
522739	SXRL 10 x 290 FUS R	433	533740	PSF 41	115	536862	FBS II 10x100 45/35/15 US	412
522951	FAZ II 12/100 HBS	409	533741	PSF 82	115	536863	FBS II 10x120 65/55/35 US	412
522952	FAZ II 12/120 HBS	409	533742	PSF 124	115	536864	FBS II 10x140 85/75/55 US	412
522953	FAZ II 16/160 HBS	409	533743	PFUF OC	121	536865	FBS II 10x160 105/95/75 US	412
522954	FAZ II 16/200 HBS	409	533744	PWK 200/200	117	536866	FBS II 10x200 145/135/115 US	412
523303	FIS SB HIGH SPEED 390 S	425	533745	PFFF 2L	122	536867	FBS II 10x230 175/165/145 US	412
524047	TZA M10	193	534880	FIS V 410 C	427	536868	FBS II 10x260 205/195/175 US	412
524170	FIS A M 10 x 130 8.8	426	534960	PVB	118	536869	FBS II 12x70 10/-/- US	412
530419	FNA II 6 x 30/15	418	535266	PSFQ 41	115	536870	FBS II 12x85 25/10/- US	412
530946	SXRL 14 x 80 FUS	433	535267	PFAF 4	124	536871	FBS II 12x110 50/35/10 US	412
530947	SXRL 14 x 100 FUS	433	535268	PFFF 4L	122	536872	FBS II 12x130 70/55/30 US	412
530948	SXRL 14 x 120 FUS	433	535269	PSAE 300	120	536873	FBS II 12x150 90/75/50 US	412
530949	SXRL 14 x 140 FUS	433	535270	PSAE 500	120	536874	FBS II 14x75 10/-/- US	412
530950	SXRL 14 x 160 FUS	433	535271	PU 10,5 Washer	120	536875	FBS II 14x95 30/10/- US	412
530951	SXRL 14 x 180 FUS	433	535272	PU 12,5 Washer	120	536876	FBS II 14x100 35/15/- US	412
530952	SXRL 14 x 200 FUS	433	535273	PU 12,5 Washer	126	536877	FBS II 14x125 60/40/10 US	412
530953	SXRL 14 x 230 FUS	433	535274	PFUF 3DL	126	536878	FBS II 14x150 85/65/35 US	412
530954	SXRL 14 x 260 FUS	433	535275	PFUF 3DR	126	536880	FBS II 8x60 10/- SK	413
530955	SXRL 14 x 80 FUS R	433	535494	FRSM 3/8"	45	536881	FBS II 8x80 30/15 SK	413
530956	SXRL 14 x 100 FUS R	433	535497	FRSM 1/2"	45	536882	FBS II 8x90 40/25 SK	413
530957	SXRL 14 x 120 FUS R	433	535498	FRSM 3/4"	45	536884	FBS II 10x65 10/-/- SK	413
530958	SXRL 14 x 140 FUS R	433	535499	FRSM 1"	45	536885	FBS II 10x80 25/15/- SK	413
530959	SXRL 14 x 160 FUS R	433	535500	FRSM 1 1/4"	45	536886	FBS II 10x95 40/30/10 SK	413
530960	SXRL 14 x 180 FUS R	433	535501	FRSM 1 1/2"	45	536887	FBS II 10x100 45/35/15 SK	413
530961	SXRL 14 x 200 FUS R	433	535502	FRSM 2"	45	536888	FBS II 10x120 65/55/35 SK	413
530962	SXRL 14 x 230 FUS R	433	535503	FRSM 2 1/2"	45	536978	FCA 21D - 300	108
530963	SXRL 14 x 260 FUS R	433	535504	FRSM 3"	45	536979	FCA 21D - 450	108
531134	TKLS Ø 9	203	535505	FRSM 110 mm	45	536980	FCA 21D - 600	108
531136	TKLS Ø 11	203	535506	FRSM 4"	45	537065	FHB II-A L M12 x 100/50 GS A4	424
531137	TKLS Ø 13	203	535507	FRSM 133 mm	45	537149	FIS VL 300 T with Clip	430
531138	TKLS Ø 17	203	535508	FRSM 5"	45	537200	FUP 8	414
531573	FIS V 300 T	427	535509	FRSM 160 mm	45	537201	FUP 10	414
532187	FCHS 1/2"	58	535511	FRSM 6"	45	537202	FUP 12	414
532190	FCHS 3/4"	58	535531	FUS 21D/2,0 - 6 m	99	537203	FUP 14	414
532195	FCHS 1"	58	535531	FUS 21D/2,0 - 6 m	155	537207	FCA 21 - 200	107
532197	FCHS 1-1/4"	58	535532	MU M 20	215	537208	FCA 21 - 300	107
532198	FCHS 1-1/2"	58	535534	MU M 24	215	537209	FCA 21 - 450	107
532230	EA II M 6 x 25	416	535535	GS 8/120	204	537210	BLR 100 M10	213
532231	EA II M 8 x 25	416	535536	GS 8/180	204	537211	SPS M 10	213
532232	EA II M 10 x 25	416	535537	SKS 10 x 65	214	537212	FGRS 8 - 11	27
532233	EA II M 12 x 25	416	535538	SKS 12 x 25	157	537213	RD 3/4" / M 12 long	217
532356	FRSP 5"	54	535538	SKS 12 x 25	214	537214	RD 3/4" / M 16 long	217
532380	RCWR 2 1/2"	60	535539	SKS 12 x 65	157	537215	RD 1/2" / M 10 long	217
532568	EHS M 12 x 25 Plus	417	535539	SKS 12 x 65	214	537580	FFF 1 hdg	269
532607	EBB 8 x 25	417	535540	U 16 x 40	214	537581	FFF 3L hdg	269
532608	EBB 10 x 25	417	535541	STST 12 x 100	208	537582	FFF 4 hdg	269
532609	EBB 12 x 25	417	535542	STST 12 x 160	208	537583	FFF 4T hdg	269
532610	EBB 15 x 25	417	536851	FBS II 8x55 5/- US TX	412	537584	FFF 4D hdg	269
533158	FMB T30 MaxxBit W 5	414	536852	FBS II 8x70 20/5 US TX	412	537585	FUF 4Y hdg	272
533159	FMB T40 MaxxBit W 5	414	536853	FBS II 8x80 30/15 US TX	412	537586	FUF 180°L hdg	272
533731	PUWS 2 x 2/135°	116	536854	FBS II 8x90 40/25 US TX	412	537587	FUF 180°R hdg	272
533733	PUWS 2 x 2	116	536855	FBS II 8x100 50/35 US TX	412	537588	FUF 21 hdg	271
533734	PUWS 4 x 4	116	536856	FBS II 8x110 60/45 US TX	412	537589	FUF 41 hdg	271
533735	PFAF 2	123	536857	FBS II 8x130 80/65 US TX	412	537590	FUF 8T hdg	272

Art.-No.	Article	Page	Art.-No.	Article	Page	Art.-No.	Article	Page
537591	FUF OC 62 hdg	237	538117	WK 100/100 hdg	263	538663	HK 31 8,5	92
537653	FUS 21/2,0 - 3 m hdg	233	538118	WK 200/200 hdg	263	538664	HK 31 10,5	92
537656	FUS 41/2,0 - 6 m hdg	233	538120	FSB 45° hdg	266	538665	SF Clix 31	87
537658	FUS 41/2,5 - 6 m hdg	233	538122	TKR 21- 42 hdg	267	538666	MW Clix 90°	89
537659	FUS 21D/2,0 - 3 m hdg	233	538123	TKR 82 hdg	267	538667	MWU 90°	91
537661	FUS 21D/2,0 - 6 m hdg	233	538124	TKR 124 hdg	267	538668	MW 90°	91
537662	FUS 41D/2,5 - 6 m hdg	233	538125	SF L 82 hdg	261	538702	FAZ II 12/100 GS	408
537663	FUS 62D/2,5 - 6 m hdg	233	538126	SF L 124 hdg	261	538703	FAZ II 12/120 GS	408
537680	SKS 12 x 25 hdg	274	538131	FIS V 410 C	427	538738	ALK 17-200	73
537681	SKS 10 x 25 hdg	274	538150	FIAM 310	449	538739	ALK 17-300	73
537682	U 8 x 28 mz	273	538151	FIAM 310	449	538740	ALK 30-200	73
537683	U 10 x 21 mz	273	538152	FIAM 310	449	538741	ALK 30-300	73
537684	U 10 x 40 mz	273	538240	DuoPower 6 x 50	436	538742	ALK 30-450	73
537685	U 12 x 24 mz	273	538241	DuoPower 8 x 65	436	538743	ALK 37-300	73
537686	U 12 x 40 mz	273	538242	DuoPower 10 x 80	436	538744	ALK 37-450	73
537687	MU M8 hdg	274	538243	DuoPower 12 x 60	436	538745	ALK 37-600	73
537688	MU M10 hdg	274	538244	DuoPower 14 x 70	436	538749	WS 31-45°	77
537689	MU M12 hdg	274	538245	DuoPower 6 x 50 S	436	538751	TKR 31	93
537690	MU M16 hdg	274	538246	DuoPower 8 x 65 S	436	538752	EMS 31	195
537691	G 8 hdg	273	538247	DuoPower 10 x 80 S	436	538753	FLS 17/1,0 - 2 m	69
537694	G 10 hdg	273	538248	DuoPower 12 x 60 S	436	538754	FLS 17/1,0 - 3 m	69
537695	G 12 hdg	273	538249	DuoPower 14 x 70 S	436	538755	FLS 30/1,0 - 2 m	69
537696	G 16 hdg	273	538430	FAZ II 12/80 GS	408	538756	FLS 30/1,0 - 3 m	69
537981	FRS 12 - 15 M8/M10 zl	229	538431	FAZ II 12/160 GS	408	538757	FLS 37/1,2 - 2 m	69
537982	FRS 15 - 19 M8/M10 zl	229	538432	FAZ II 12/200 GS	409	538758	FLS 37/1,2 - 3 m	69
537983	FRS 20 - 24 M8/M10 zl	229	538433	FAZ II 12/140 GS	408	538759	FLS 37/1,2 - 6 m	69
537984	FRS 25 - 30 M8/M10 zl	229	538434	FAZ II 12/180 GS	409	538989	FAZ II 8/5 K	407
537985	FRS 32 - 37 M8/M10 zl	229	538458	FFD 26 x 12 x 6	415	538990	FAZ II 8/5 K R	407
537986	FRS 40 - 45 M8/M10 zl	229	538459	FFD 30 x 14 x 6	415	539443	FRS-L 8 - 11 Universal	33
537987	FRS 48 - 54 M8/M10 zl	229	538460	FFD 38 x 19 x 7	415	539444	FRS-L 12 - 15 Universal	33
537988	FRS 55 - 61 M8/M10 zl	229	538549	FIS VL 410 C in bucket	430	539445	FRS-L 16 - 19 Universal	33
537989	FRS 63 - 67 M8/M10 zl	229	538577	Nut 1/2" SW10	414	539446	FRS-L 20 - 24 Universal	33
537990	FRS 72 - 80 M8/M10 zl	229	538578	Nut SW13	414	539447	FRS-L 25 - 30 Universal	33
537991	FRS 87 - 92 M8/M10 zl	229	538579	Nut SW15	414	539448	FRS-L 31 - 37 Universal	33
537992	FRS 108 - 116 M8/M10 zl	229	538580	Nut SW17	414	539449	FRS-L 38 - 45 Universal	33
537993	FRS 121 - 128 M8/M10 zl	229	538581	Nut SW21	414	539450	FRS-L 46 - 52 Universal	33
537994	FRS 133 - 141 M8/M10 zl	229	538583	FIS VL 300 T with Clip	430	539451	FRS-L 53 - 59 Universal	33
537995	FRS 159 - 165 M8/M10 zl	229	538584	FIS VL 410 C	430	539452	FRS-L 60 - 66 Universal	33
537996	FRS 165 - 168 M8/M10 zl	229	538585	FIS VL 300 T HIGH SPEED with Clip	430	539453	FRS-L 67 - 75 Universal	33
538015	FCA 62 - 1000 hdg	239	538586	FIS VL 410 C HIGH SPEED	430	539454	FRS-L 76 - 84 Universal	33
538016	FCA 41D - 750 hdg	239	538589	FIS VL 300 T HWK big	430	539455	FRS-L 85 - 93 Universal	33
538017	FCA 41D - 1000 hdg	239	538590	FIS VL 410 C HWK big	430	539456	FRS-L 94 - 100 Universal	33
538018	FCAM 300 hdg	242	538641	SV 31	79	539457	FRS-L 101 - 110 Universal	33
538019	FCAM 400 hdg	242	538643	FSM Clix P 6	81	539459	FRS-L 110 - 119 Universal	33
538020	FCAM 500 hdg	242	538647	FSM Clix P 8	81	539461	FIS VL 300 T	430
538021	FCAM 600 hdg	242	538649	FSM Clix P 10	81	539462	FIS VL 300 T in bucket	430
538022	FCAM 700 hdg	242	538650	FSM Clix M 6	83	539463	FIS VL 410 C	430
538080	RD M 16 / M 12 long	217	538651	FSM Clix M 8	83	539464	FIS VL 410 C in bucket	430
538082	FRSL 34 M8	56	538652	FSM Clix M 10	83	539477	FRS K 219/19	49
538083	FRSL 43 M8	56	538653	FHS Clix 8 x 30	85	539564	FUBD 40	62
538084	FRSL 49 M8	56	538654	FHS Clix 8 x 40	85	539566	FUBD 52	62
538085	FRSL 60 M8	56	538655	FHS Clix 8 x 60	85	539567	FUBD 60	62
538106	FCN Clix P 8 hdg	259	538656	FHS Clix 8 x 80	85	539568	FUBD 76	62
538107	FCN Clix P 10 hdg	259	538657	FHS Clix 8 x 100	85	539569	FUBD 94	62
538108	FCN Clix M 8 hdg	259	538658	FHS Clix 10 x 30	85	539570	FUBD 100	62
538109	FCN Clix M 10 hdg	259	538659	FHS Clix 10 x 40	85	539660	FRS 200-206 M10	37
538110	FCN Clix M 12 hdg	259	538660	FHS Clix 10 x 60	85	540127	SXRL 8 x 60 FUS	433
538115	UWS hdg	262	538661	FHS Clix 10 x 100	85	540129	SXRL 8 x 80 FUS	433

Art.-No.	Article	Page	Art.-No.	Article	Page	Art.-No.	Article	Page
540130	SXRL 8 x 100 FUS	433	543397	FAZ II 10/20 H R	407	544933	SHA M 15	367
540131	SXRL 8 x 120 FUS	433	543398	FAZ II 12/10 H R	407	544934	SHA M 30	367
540133	SXRL 8 x 140 FUS	433	543399	FAZ II 12/20 H R	407	544935	SHA M 70	367
540134	SXRL 8 x 160 FUS	433	543565	FBS II 8x60 10/- US R	413	545117	FUS 21/1,5 - 2 m	99
540135	SXRL 8 x 60 FUS R	433	543566	FBS II 8x70 20/5 US R	413	545118	FUS 21/1,5 - 3 m	99
540136	SXRL 8 x 80 FUS R	433	543567	FBS II 8x80 30/15 US R	413	545119	FUS 21/1,5 - 6 m	99
540137	SXRL 8 x 100 FUS R	433	543568	FBS II 8x90 40/25 US R	413	545120	FUS 41/1,5 - 2 m	99
541441	KP M3	444	543569	FBS II 10x60 5/-/- US R	413	545126	FUS 41/1,5 - 3 m	99
541712	HTM WH 290 (DE/EN)	442	543570	FBS II 10x70 15/5/- US R	413	545127	FUS 41/1,5 - 6 m	99
541891	FA-ST M10	409	543571	FBS II 10x80 25/15/- US R	413	545512	FHY M12	420
541892	FA-ST M12	409	543572	FBS II 10x90 35/25/5 US R	413	545522	KB N 8	363
541987	FFD 30 x 14 x 6 R	415	543573	FBS II 10x100 45/35/15 US R	413	545523	KB N 16	363
542621	FAZ II 6/10	405	543574	FBS II 10x120 65/55/35 US R	413	545636	FDN II 6/5	419
542622	FAZ II 6/20	405	543575	FBS II 12x70 10/-/- US R	413	545637	FDN II 6/35	419
542623	FAZ II 6/10 R	405	543576	FBS II 12x85 25/10/- US R	413	545638	FDN II 6/5 K	419
542624	FAZ II 6/20 R	405	543577	FBS II 12x110 50/35/10 US R	413	545639	FDN II 6/35 K	419
542708	PUWS 2 x 2/135° zl	248	543578	FBS II 12x130 70/55/30 US R	413	545649	FRS 95 - 103 M8/M10	37
542709	PUWS 2 x 2 zl	248	543579	FBS II 8x60 10/- SK R	414	545650	VB	143
542710	PUWS 4 x 4 zl	248	543580	FBS II 8x80 30/15 SK R	414	545651	VB A2	334
542711	PFAF 2 zl	254	543581	FBS II 8x90 40/25 SK R	414	545771	VB hdg	265
542712	PFAF 3 zl	254	543582	FBS II 10x65 10/-/- SK R	414	545772	AMD 10 - 12	375
542713	PFAF 4/135° zl	255	543583	FBS II 10x80 25/15/- SK R	414	545773	AMD 14 - 16	375
542714	PFUF 41 zl	256	543584	FBS II 10x95 40/30/10 SK R	414	545774	AMD 17 - 19	375
542715	PSF 41 zl	247	543585	FBS II 10x100 45/35/15 SK R	414	545775	AMD 20 - 23	375
542716	PSF 82 zl	247	543586	FBS II 10x120 65/55/35 SK R	414	545776	AMD 24 - 27	375
542718	PSF 124 zl	247	543924	GBN 2,5 x 100	385	545786	FCTP-W	387
542719	PFUF OC zl	237	543925	GBN 2,5 x 150	385	545787	FCTP-B	387
542720	PWK 200/200 zl	249	543926	GBN 2,5 x 200	385	545792	FWSC 30 - 55	369
542721	PFFF 2L zl	253	543927	GBN 3,6 x 150	385	545834	FHS Clix 8 x 140	85
542722	PVB zl	250	543928	GBN 4,6 x 200	385	545835	FHS Clix 8 x 190	85
542723	PSFQ 41 zl	247	543929	GBN 4,8 x 280	385	545836	FHS Clix 10 x 80	85
542724	PFAF 4 zl	254	543965	FLS cutting tool	72	545839	SX 6 x 30 S PH TX	438
542725	PFFF 4L zl	253	543977	Cap nut FAZ II M10	407	545853	FIS MR Plus	422
542726	PSAE zl 300	252	543978	Cap nut FAZ II M12	407	546148	FDCC	104
542727	PSAE zl 500	252	543979	Cap nut FAZ II M10 R	407	546377	FBS II 6 x 30/5 P	415
542728	PU zl 10,5 Washer	252	543980	Cap nut FAZ II M12 R	407	546378	FBS II 6 x 40/5 P	415
542729	PU zl 12,5 Washer	252	544079	FBS-UL	453	546379	FBS II 6 x 40/5 LP	415
542730	PFUF 3DL zl	257	544083	FBB-UL FireStop Block	453	546380	FBS II 6 x 60/5 P	415
542731	PFUF 3DR zl	257	544084	FBS-EN	453	546381	FBS II 6 x 80/25 P	415
542732	PFUF 4D zl	257	544085	FBS-EN	453	546382	FBS II 6 x 30/5 SK	415
542733	PFCN 41 zl	245	544086	FBS-EN	453	546383	FBS II 6 x 40/5 SK	415
542735	FUS 21/2,0 A2 - 6 m	329	544087	FBS-EN	453	546384	FBS II 6 x 60/5 SK	415
542736	FUS 41/2,0 A2 - 6 m	329	544088	FBB-EN FireStop Block	453	546385	FBS II 6 x 80/25 SK	415
542737	FUS 41/2,5 A2 - 6 m	329	544089	FIB Insulating Bandage	453	546386	FBS II 6 x 100/45 SK	415
542738	FUS 21/2,0 A4 - 6 m	329	544090	FFBD Foam Barrier Dispenser	453	546387	FBS II 6 x 120/65 SK	415
542739	FUS 41/2,0 A4 - 6 m	329	544589	GS 6/25	204	546388	FBS II 6 x 140/85 SK	415
542740	FUS 41/2,5 A4 - 6 m	329	544590	GS 6/40	204	546389	FBS II 6 x 160/105 SK	415
542960	LGS 630	187	544591	GS 6/50	204	546390	FBS II 6 x 40/5 US	415
542962	LGS 710	187	544592	GS 6/70	204	546391	FBS II 6 x 60/5 US	415
543060	FVS 3 II	154	544593	GS 6/80	204	546392	FBS II 6 x 80/25 US	415
543063	FVS 4 II	154	544594	GS 6/100	204	546393	FBS II 6 x 100/45 US	415
543065	FUH 13	145	544595	U 6 x 12	214	546394	FBS II 6 x 120/65 US	415
543065	FUH 13	159	544905	FRS-L 120 - 129 Universal	33	546395	FBS II 6 x 25 M8/19	416
543392	FAZ II 10/10 H	407	544906	FRS-L 130 - 137 Universal	33	546396	FBS II 6 x 35 M8/19	416
543393	FAZ II 10/20 H	407	544907	FRS-L 138 - 145 Universal	33	546397	FBS II 6 x 55 M8/19	416
543394	FAZ II 12/10 H	407	544908	FRS-L 146 - 155 Universal	33	546398	FBS II 6 x 35 M10/21	416
543395	FAZ II 12/20 H	407	544909	FRS-L 156 - 163 Universal	33	546399	FBS II 6 x 55 M10/21	416
543396	FAZ II 10/10 H R	407	544910	FRS-L 164 - 172 Universal	33	546400	FBS II 6 x 35 M8/M10 I	416

Art.-No.	Article	Page	Art.-No.	Article	Page	Art.-No.	Article	Page
546401	FBS II 6 x 55 M8/M10 I	416	547818	FMCE-L M12	293	547878	FMPS 40 1/2-150	320
546506	SXRL 10 x 60 FUS	433	547819	FMCE-L M16	293	547879	FMPS 50 1/2-80	319
546507	SXRL 10 x 60 FUS R	433	547820	FMCE-L M20	293	547880	FMPS 50 1/2-150	320
547492	HK 41 8,5	134	547821	FMSF 90S	297	547881	FMPS 65 1/2-80	319
547493	HK 41 10,5	134	547822	FMSF 90M	297	547882	FMPS 65 1/2-150	320
547494	HK 41 12,5	134	547823	FMSF 90L	297	547883	FMPS 80 1/2-80	319
547494	HK 41 12,5	156	547824	FMSF 120S	297	547884	FMPS 80 1/2-150	320
547495	HK 41 10,5 hdg	260	547825	FMSF 120M	297	547885	FMPS 100 1/2-110	320
547496	HK 41 12,5 hdg	260	547826	FMSF 120L	297	547886	FMPS 100 1/2-150	320
547497	HK 41 12,5 - A4	335	547827	FMSF 160M	297	547887	FMPS 125 1/2-110	320
547500	FFF 1	139	547828	FMSF 160L	297	547888	FMPS 125 1/2-150	320
547501	FFF 4	139	547829	FMSF BP S	295	547889	FMPS 150 1/2-110	320
547502	FAF 2	140	547830	FMSF BP M	295	547890	FMPS 150 1/2-150	320
547503	FAF 3	140	547831	FMSF BP L	295	547891	FMPS 200 1/2-110	320
547504	FAF 4	140	547832	FMVB-P	299	547892	FMPS 200 1/2-150	320
547505	FAF 4/135°	140	547833	FMVB BP S	299	547893	FMPS 250 2/2-110	320
547508	FAF 2 hdg	270	547834	FMVB BP M	299	547894	FMPS 300 2/2-110	320
547509	FAF 3 hdg	270	547835	FMVB BP L	299	547895	FMPS 350 2/2-110	320
547510	FAF 4 hdg	270	547836	FMBC 90	301	547896	FMPS 400 2/2-110	320
547511	FAF 4/135° hdg	270	547837	FMBC 120	301	547897	FMPS 500 2/2-110	320
547512	FAF 2 A4	333	547838	FMBC 160	301	547898	FMPS 600 2/2-110	320
547513	FAF 4 A4	333	547839	FMBC M12	303	547899	FMPS 250 2/2-150	320
547514	FAF 4/135° A4	333	547840	FMBC M16	303	547900	FMPS 300 2/2-150	321
547515	FFD 22 x 9 x 6	415	547841	FMFF 90°	305	547901	FMPS 350 2/2-150	321
547763	FSF-FM gvz	176	547842	FMA 3	307	547902	FMPS 400 2/2-150	321
547765	FSSC-FM 73 gvz	174	547843	FMA 4	307	547903	FMPS 500 2/2-150	321
547766	FSSC-FM 76 gvz	174	547844	FMA 90	309	547904	FMPS 600 2/2-150	321
547767	FSSC-FM 89 gvz	174	547845	FMA 120	309	547905	FMFSC 25	323
547768	FSSC-FM 108 gvz	174	547846	FMA 160	309	547906	FMFSC 32	323
547769	FSSC-FM 114 gvz	174	547847	FMUF 90	311	547907	FMFSC 40	323
547770	FSSC-FM 133 gvz	174	547848	FMUF 120	311	547909	FMFSC 50	323
547771	FSSC-FM 139 gvz	174	547849	FMUF 160	311	547910	FMFSC 65	323
547772	FSSC-FM 159 gvz	174	547850	FMFS UB 90	313	547911	FMFSC 80	323
547773	FSSC-FM 168 gvz	174	547851	FMFS UB 120	313	547913	FMFSC 100	323
547783	FUSF 41 gvz	175	547852	FMFS UB 160	313	547915	FMFSC 125	323
547784	FUSF 62 gvz	175	547853	FMFS SP	315	547918	FMFSC 150	323
547785	FUSF 41D gvz	175	547854	FMFS SH	315	547919	FMFSC 200	323
547786	FUSF 62D gvz	175	547855	FMFS DP4	315	547921	FMFSC 250/50	323
547791	FTRC M12 gvz	182	547856	FMFS DP6	315	547929	FMPSU 25	325
547795	FMP 90 3m	281	547857	FMFS LL	315	547930	FMPSU 32	325
547796	FMP 90 6m	281	547860	FMFS S	317	547931	FMPSU 40	325
547797	FMP 120 3m	281	547861	FMFS M	317	547933	FMPSU 50	325
547798	FMP 120 6m	281	547862	FMPS 25 1/1-80	319	547934	FMPSU 65	325
547799	FMP 160 6m	281	547863	FMPS 40 1/1-80	319	547935	FMPSU 80	325
547800	FMP 160 8m	281	547864	FMPS 50 1/1-80	319	547937	FMPSU 100	325
547801	FMPC	285	547865	FMPS 65 1/1-80	319	547939	FMPSU 125	325
547802	FMC 90-500	286	547866	FMPS 80 1/1-80	319	547941	FMPSU 150	325
547803	FMC 90-750	286	547867	FMPS 40 1/1-150	319	547942	FMPSU 200	325
547804	FMC 90-1000	286	547868	FMPS 50 1/1-150	319	547943	FMPSU 250	325
547805	FMC 90-1500	286	547869	FMPS 65 1/1-150	319	548410	FMPS 25 1/1-150	319
547806	FMEC 90	289	547870	FMPS 80 1/1-150	319	550806	EMS 41	195
547807	FMEC 120	289	547871	FMPS 100 1/1-150	319	552056	FHB II-A L M20 x 210/200	425
547808	FMEC 160	289	547872	FMPS 125 1/1-150	319	552057	FHB II-A S M24 x 170/70	424
547809	FMHB	291	547873	FMPS 150 1/1-150	319	552149	SZE	223
547810	FMSB MU M12	291	547874	FMPS 200 1/1-150	319	552149	SZE	383
547815	FMCE M12/M16	294	547875	FMPS 25 1/2-80	319	552150	Toolset for SZE	223
547816	FMCE 1/2"	294	547876	FMPS 25 1/2-150	320	552150	Toolset for SZE	383
547817	FMCE 3/4"	294	547877	FMPS 40 1/2-80	319	552360	S-VA	178

Art.-No.	Article	Page	Art.-No.	Article	Page	Art.-No.	Article	Page
552361	S-ROD	181	557374	FRS 95 - 103 M8/M10 zl	229	559432	FIS V 360 S	427
552362	S-VB	179	557375	FHBC	224	559435	FIS V 360 S	427
552363	S-FAF	180	557376	FDCC A4	330	559698	GS 8/40 A4	337
552441	SKS TB M12x30	183	557844	FPB T 50 5/16" Profi Bit W 10	414	559699	GS 8/60 A4	337
552858	FRSM 305 - 316 M12/M16	47	557872	Setting tool SC-ST 8	414	559700	GS 10/40 A4	337
552859	KFT 273	52	557874	Setting tool SC-ST 10	414	559701	GS 10/60 A4	337
552860	KFT 323,9	52	558148	FUDB 48	62	559702	MU M 8 A4	339
553073	FFF 5C	139	558303	FRSM 177 - 183 M10/M12	47	559703	MU M 10 A4	339
553075	FFF 5C hdg	269	558304	FRSM 277 - 283 M12/M16	47	559704	SKS M 10 x 30 A4	339
553076	FUF 62	141	558335	FRS 210-219 M10	37	559705	SKS M 12 x 30 A4	339
553083	FUF 62 hdg	271	558524	FRSM 1/2" M10/M12 hdg	231	559706	VM M 8 A4	338
553363	RC IEC 19	351	558525	FRSM 3/4" M10/M12 hdg	231	559707	VM M 10 A4	338
553383	SF plus RC IEC 19	351	558526	FRSM 1" M10/M12 hdg	231	559752	FCN Clix M 8 A4	336
553637	GPL M 8/M 10	206	558527	FRSM 1 1/4" M10/M12 hdg	231	559753	FCN Clix M 10 A4	336
553733	KSU 450	345	558528	FRSM 1 1/2" M10/M12 hdg	231	559754	FCN Clix P 8 A4	336
553734	KSU 500	345	558529	FRSM 53-58 M10/M12 hdg	231	559755	FCN Clix P 10 A4	336
553735	KSU 600	345	558530	FRSM 2" M10/M12 hdg	231	559756	FCN Clix P 12 A4	336
553736	KSU S 450	345	558531	FRSM 2 1/2" M10/M12 hdg	231	559915	FCA 41/2,0 - 300	107
553737	KSU S 500	345	558532	FRSM 79-85 M10/M12 hdg	231	559916	FCA 41/2,0 - 450	107
553738	KSU S 600	345	558533	FRSM 3" M10/M12 hdg	231	559917	FCA 41/2,0 - 600	107
553928	Nut 1/2" - 1/4"	414	558534	FRSM 102" M10/M12 hdg	231	559918	FCA 41/2,0 - 750	107
553929	Nut 1/2" - TX 50	414	558535	FRSM 124-129 M10/M12 hdg	231	559919	FCA 41/2,0 - 1000	107
554065	FBS II 6 x 35 M6 I	416	558536	FRSM 131-137" M10/M12 hdg	231	559920	FCA 41D/2,0 - 750	108
554066	FBS II 6 x 55 M6 I	416	558537	FRSM 138-145 M10/M12 hdg	231	559921	FCA 41D/2,0 - 1000	108
554236	FMPC 90	285	558538	FRSM 156-162 M10/M12 hdg	231	579746	G 12/2	204
554237	FMPC 120	285	558539	FRSM 165-171 M10/M12 hdg	231			
554238	FMPC 160	285	558540	FRSM 188-194 M10/M12 hdg	231			
554239	FMCE-L short M12	293	558541	FRSM 196-203 M10/M12 hdg	231			
554240	FMCE-L short M16	293	558542	FRSM 212 M12/M16 hdg	231			
554241	FMCE-L short M20	293	558543	FRSM 8" M12/M16 hdg	231			
554242	FMVB-PII	299	558544	FRSM 250 M12/M16 hdg	231			
554243	FRSM 1/2" M10/M12	47	558545	FRSM 10" M12/M16 hdg	231			
554244	FRSM 3/4" M10/M12	47	558546	FRSM 300 M12/M16 hdg	231			
554245	FRSM 1" M10/M12	47	558547	FRSM 305-316 M12/M16 hdg	231			
554246	FRSM 1 1/4" M10/M12	47	558548	FRSM 12" M12/M16 hdg	231			
554247	FRSM 1 1/2" M10/M12	47	558549	FRSM 348-356 M16 hdg	231			
554248	FRSM 53 - 58 M10/M12	47	558596	FRSM 364-372 M16 hdg	231			
554249	FRSM 2" M10/M12	47	558597	FRSM 400-409 M16 hdg	231			
554250	FRSM 2 1/2" M10/M12	47	558598	FRSM 454-462 M16 hdg	231			
554251	FRSM 79 - 85 M10/M12	47	558599	FRSM 500-508 M16 hdg	231			
554252	FRSM 3" M10/M12	47	558606	FRSM 4" M10/M12 hdg	231			
554253	FRSM 102 M10/M12	47	558744	FIS V Plus 360 S (IN)	431			
554254	FRSM 4" M10/M12	47	558745	FIS V Plus 360 S (DE)	431			
555005	DuoPower 5 x 25	436	558746	FIS V Plus 360 S (EN,ES,PT)	431			
555006	DuoPower 6 x 30	436	558747	FIS V Plus 360 S (AR,ZH,EN)	431			
555008	DuoPower 8 x 40	436	558752	FIS V Plus 360 S (DE,FR,NL)	431			
555010	DuoPower 10 x 50	436	558753	FIS V Plus 360 S (IT,PL,RO)	431			
555105	DuoPower 5 x 25 S	436	558754	FIS V Plus 360 S (TR,EL,AR)	431			
555106	DuoPower 6 x 30 S	436	558755	FIS V Plus 360 S (DK,NO,SE,FI)	431			
555108	DuoPower 8 x 40 S	436	558758	FIS V Plus 360 S (EN,ES,PT)	431			
555110	DuoPower 10 x 50 S	436	558760	FIS V Plus 360 S (RU,UK,KK)	431			
557092	G 10/3	204	558762	FIS V Plus 360 S (CS,SK,HU)	431			
557270	G 24	204	558780	FIS V Plus 410 C (IT,DE,EN)	431			
557278	FDCC zl	275	558784	FIS V Plus 410 C (EN,ES,PT)	431			
557295	G 20	204	559131	FIS V 360 S	427			
557297	MU M 16	215	559132	FIS V 360 S	427			
557301	U 12 x 24	214	559133	FIS V 360 S	427			
557303	U 16 x 30	214	559429	FIS V 360 S	427			

The information in this catalogue is intended for general guidance only and is given without engagement. Additional information and advice on specific applications is available from our Technical Support Team. For this however, we require a precise description of your particular application.

All the data in this catalogue concerning work with our fixing elements must be adapted to suit local conditions and the type of materials in use.

If no detailed performance specifications are given for certain articles and types, please contact our Technical Service Department for advice.

fischerwerke GmbH & Co. KG
72178 Waldachtal
Germany

We cannot be responsible for any errors, and we reserve the right to make technical and range modifications without notice. No liability is accepted for printing errors and omissions.

Your dealer

www.fischer-international.com



fischer stands for

Fixing Systems
Automotive
fischertechnik
Consulting
LNT Automation

fischerwerke GmbH & Co. KG
Klaus-Fischer-Straße 1 · 72178 Waldachtal
Germany
T +49 7443 12-0
www.fischer-international.com · info@fischer.de

